



DCS GUIDE
P-47D THUNDERBOLT

BY CHUCK
LAST UPDATED: 20/09/2023

TABLE OF CONTENTS

- PART 1 – INTRODUCTION
- PART 2 – CONTROLS SETUP
- PART 3 – COCKPIT & EQUIPMENT
- PART 4 – START-UP PROCEDURE
- PART 5 – TAKEOFF
- PART 6 – LANDING
- PART 7 – ENGINE & FUEL MANAGEMENT
- PART 8 – AERODYNAMICS & LIMITATIONS
- PART 9 – WEAPONS
- PART 10 – RADIO
- PART 11 – NAVIGATION
- PART 12 – AIRCRAFT VARIANTS
- PART 13 – AIR COMBAT
- PART 14 – TAMING TAILDRAGGERS



The **Republic P-47 Thunderbolt** was a World War II-era fighter aircraft produced by the American aerospace company Republic Aviation from 1941 through 1945. Its primary armament was eight .50-caliber machine guns, and in the fighter-bomber ground-attack role it could carry five-inch rockets or a bomb load of 2,500 pounds. When fully loaded, the P-47 weighed up to eight tons, making it one of the heaviest fighters of the war. The P-47 was designed around the powerful Pratt & Whitney R-2800 Double Wasp engine, which was also used by two U.S. Navy/U.S. Marine Corps fighters, the Grumman F6F Hellcat and the Vought F4U Corsair. The Thunderbolt was effective as a short-to medium-range escort fighter in high-altitude air-to-air combat and ground attack in both the European and Pacific theaters.

Originally known as the Seversky Aircraft Company, the Republic Aviation Corporation was an American aircraft manufacturer based in Farmingdale, New York, on Long Island. By April 1939, the Seversky Aircraft Corporation had lost \$550,000, and Seversky was forced out of the company he had founded back in 1931. The board, led by financier Paul Moore, voted W. Wallace Kellett to replace him as president, and in September 1939, the company was reorganized as the Republic Aviation Corporation.

The P-47 Thunderbolt itself was designed by Alexander Kartveli, a man of Georgian descent. It was to replace the Seversky P-35 developed earlier by a Russian immigrant named Alexander P. de Seversky. Both had fled from their homeland, Tbilisi, in Georgia to escape the Bolsheviks. The stories of Kartveli and Seversky are very interesting and deserve much more than a mere paragraph.



Seversky P-35



*Alexander Kartveli
(1896-1974)*



*Alexander P. de Seversky
(1894-1974)*



In 1939, Republic Aviation designed the AP-4 demonstrator powered by a Pratt & Whitney R-1830 radial engine with a belly-mounted turbocharger. A small number of Republic P-43 Lancers were built but Republic had been working on an improved P-44 Rocket with a more powerful engine, as well as on the AP-10 fighter design. The latter was a lightweight aircraft powered by the Allison V-1710 liquid-cooled V-12 engine and armed with two .50 in M2 Browning machine guns mounted in the nose and four .30 in M1919 Browning machine guns mounted in the wings. The United States Army Air Corps (USAAC) backed the project and gave it the designation XP-47. One thing that is absolutely incredible is the fact that it only took 9 months between the beginning of the design phase until the prototype's first flight... with slide rules and tracing paper. By today's standards, this design cycle can last 10 to 15 years.

In the spring of 1940, Republic and the USAAC concluded that the XP-44 and the XP-47 prototypes were inferior to Luftwaffe fighters. Republic tried to improve the design, proposing the XP-47A but this failed. Kartveli then designed a much larger fighter, which was offered to the USAAC in June 1940. The Air Corps ordered a prototype in September as the XP-47B. The XP-47A, which had little in common with the new design, was abandoned. The XP-47B was of all-metal construction (except for the fabric-covered tail control surfaces) with elliptical wings, with a straight leading edge that was slightly swept back. The air-conditioned cockpit was roomy and the pilot's seat was comfortable—"like a lounge chair", as one pilot later put it. Though the XP-47B had its share of teething troubles, the newly reorganized United States Army Air Forces placed an order for 171 production aircraft, the first being delivered in December 1941.

By the end of 1942, P-47Cs were sent to England for combat operations. The initial Thunderbolt flyers, 56th Fighter Group, was sent overseas to join the 8th Air Force. As the P-47 Thunderbolt worked up to operational status, it gained a nickname: the "Jug" (because its profile was similar to that of a common milk jug of the time). The P-47, when compared to other fighters of the time, was massive and fitted with a very powerful engine. While heavy, it was a superb firing platform and could attain very high speeds when diving. Within capable hands, this aircraft was deadly.

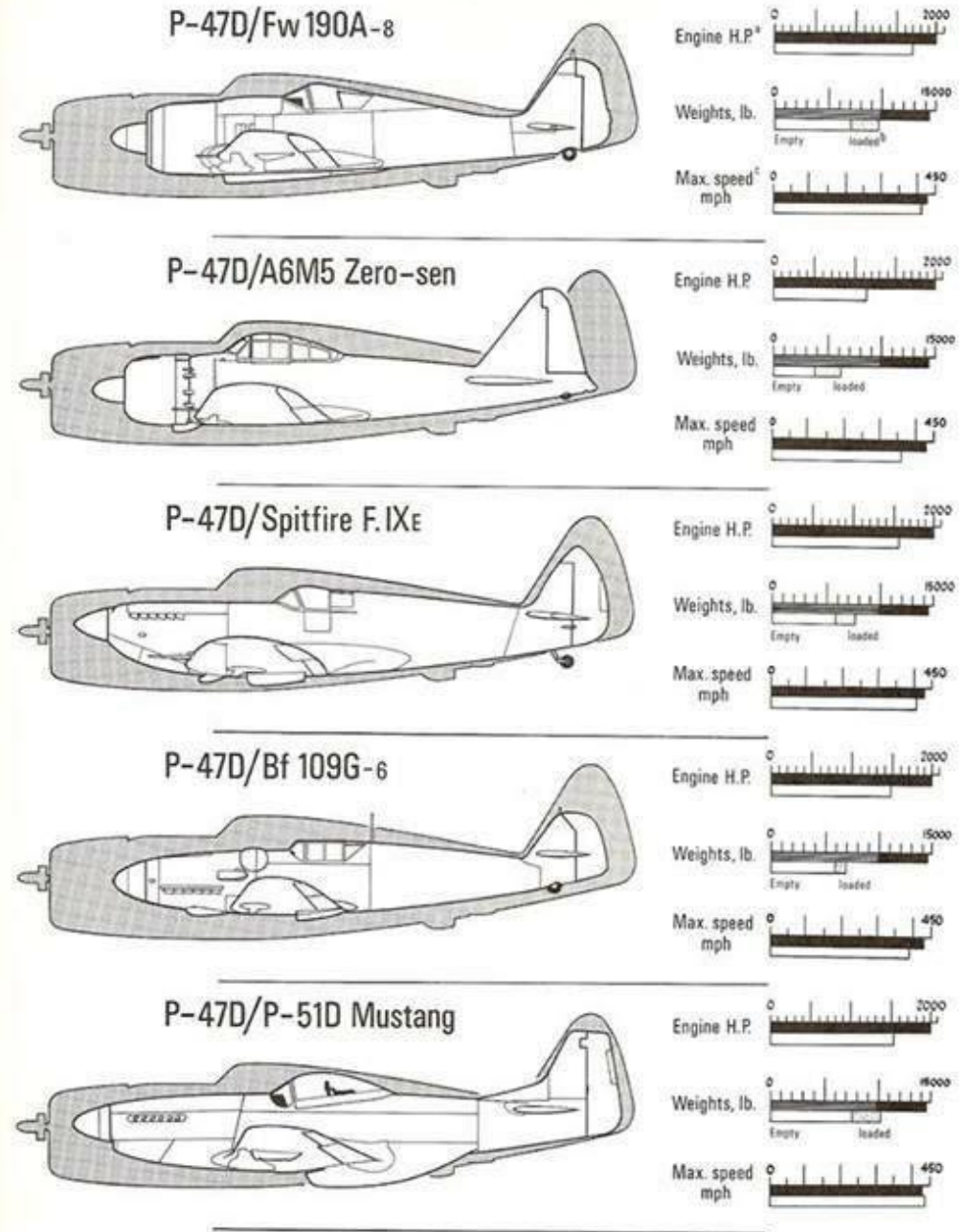

Notes
 (a) The figure used in each case is horse-power available for take-off.
 (b) External stores not included in loaded weight.
 (c) Max. speed quoted at the following altitudes: P-47, 30,000 ft.;

Fw190A-8, 20,800 ft.; A6M5, 22,000 ft.; Spitfire IX, 27,500 ft.; Bf109G-6, 22,600 ft.; P-51D, 25,000 ft.
 In each diagram the bar adjoining the scale indicates figure for P-47.

The first P-47 combat mission took place 10 March 1943 when the 4th FG took their aircraft on a fighter sweep over France. The mission was a failure due to radio malfunctions. All P-47s were refitted with British radios, and missions resumed 8 April. The first P-47 air combat took place 15 April 1943.

By mid-1943, the Jug was also in service with the 12th Air Force in Italy and against the Japanese in the Pacific, with the 348th Fighter Group flying missions out of Port Moresby, New Guinea. By 1944, the Thunderbolt was in combat with the USAAF in all its operational theaters except Alaska.

Luftwaffe ace Heinz Bär said that the P-47 "could absorb an astounding amount of lead [from shooting at it] and had to be handled very carefully". Although the North American P-51 Mustang replaced the P-47 in the long-range escort role in Europe, the Thunderbolt still ended the war with 3,752 air-to-air kills claimed in over 746,000 sorties of all types, at the cost of 3,499 P-47s to all causes in combat. By the end of the war, the 56th FG was the only 8th Air Force unit still flying the P-47, by preference, instead of the P-51.

With increases in fuel capacity as the type was refined, the range of escort missions over Europe steadily increased until the P-47 was able to accompany bombers in raids all the way into Germany. On the way back from the raids, pilots shot up ground targets of opportunity, and also used belly shackles to carry bombs on short-range missions, which led to the realization that the P-47 could perform a dual-function on escort missions as a fighter-bomber. Even with its complicated turbosupercharger system, its sturdy airframe and tough radial engine could absorb a lot of damage and still return home.

The P-47 gradually became the USAAF's primary fighter-bomber, by late 1943, early versions of the P-47D carrying 500 lbs bombs underneath their bellies, mid production versions of the P-47D could carry 1000 lbs bombs and M8 4.5 in (115 mm) rockets under their wings or from the last version of the P-47D in 1944, 5 in (127 mm) High velocity aircraft rockets (HVARs, also known as "Holy Moses"). From D-Day until VE day, Thunderbolt pilots claimed to have destroyed 86,000 railroad cars, 9,000 locomotives, 6,000 armored fighting vehicles, and 68,000 trucks. During Operation Cobra, in the vicinity of Roncey, P-47 Thunderbolts of the 405th Fighter group destroyed a German column of 122 tanks, 259 other vehicles, and 11 artillery pieces.

Famous Thunderbolt aces include Lieutenant Colonel Francis S. "Gabby" Gabreski (28 victories), Captain Robert S. Johnson (27 victories) and 56th FG Commanding Officer Colonel Hubert "Hub" Zemke (17.75 victories). All of them have fascinating stories. Despite being the sole remaining P-47 group in the 8th Air Force, the 56th FG remained its top-scoring group in aerial victories throughout the war.



Francis S. Gabreski
(1919-2002)

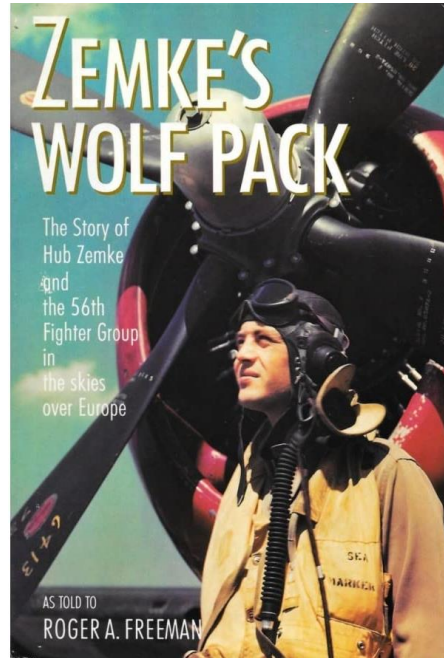

Hubert Zemke
(1914-1994)



Robert S. Johnson
(1920-1998)

After World War II, Republic continued creating aircraft such as the F-84 family (F-84F Thunderstreak, RF-84F Thunderflash) and the F-105 Thunderchief. Eventually, Republic Aviation was acquired by Fairchild in 1965. Interestingly, the Fairchild Republic A-10 Warthog (designated “Thunderbolt II”) is the direct descendant of the P-47. Both aircraft are large, sturdy and pack a real punch... “Flying Tanks” as one would call them.

During the fall of 1987, Fairchild Corporation (then Republic's parent company) destroyed Republic's corporate archives. Joshua Stoff, the curator of the Cradle of Aviation Museum on Long Island, wrote in [Air & Space Magazine](#) that, upon being invited to have a last look at the archives, he surreptitiously took one document with him. That lone surviving document was a contract for 225 P-47Bs from Republic for the US Army Air Corps at a cost of \$16,275,657.50 (War Department Contract #15850, dated September 13, 1940) is now housed at the museum.

This unbelievably stupid decision to destroy Republic's archives makes the DCS P-47 very special for me since it's a plane that has been literally brought back from the dead. In my humble opinion, Eagle Dynamics hasn't only created a mere piece of software... they have created an almost living and breathing virtual museum about one of the most precious parts of aviation history: the mighty Thunderbolt.



I hope you enjoy reading this guide as much as I enjoyed writing it. The “Jug” is an aircraft that will send shivers down your spine whenever you strafe trains or ground targets. Whether you want to fly up there with the bombers or down low with the flak and tracers, the P-47 is a very versatile aircraft that just screams American Muscle in every aspect of its design. The whirl of the turbosupercharger, the roar of the radial engine, the clanking of the machineguns... all of these sounds still inexplicably bring a silly, satisfied grin on my face... Every. Single. Time. Happy flying!



WHAT YOU NEED MAPPED

Note: Bindings in blue are for the P-47D-30 Early Variant Only.



+ TOE BRAKES (MAPPED ON PEDALS)

WHAT YOU NEED MAPPED

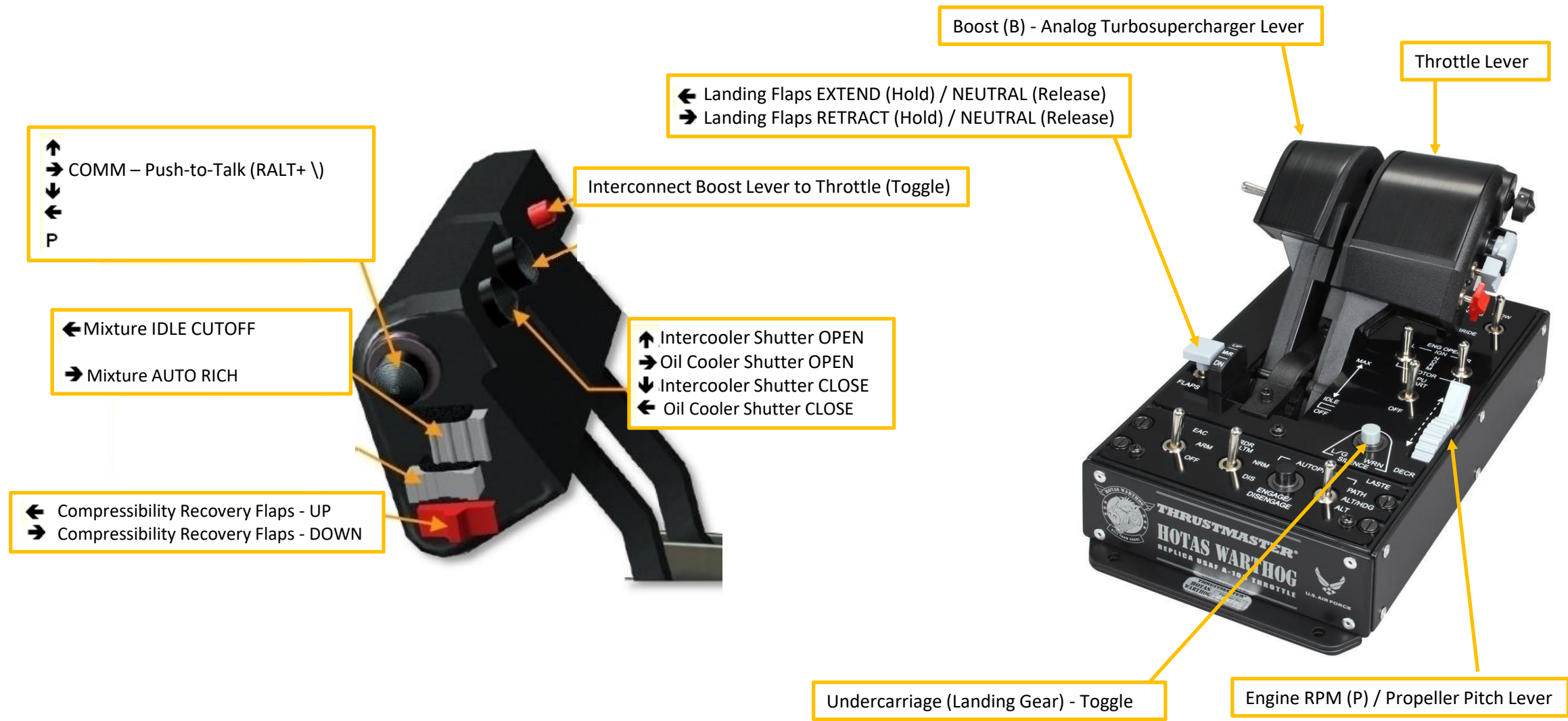

OPTIONS

SYSTEM **CONTROLS** GAMEPLAY MISC. AUDIO SPECIAL VR

P-47D-30 Sim Axis Commands Foldable view Reset category to default Clear category Save profile as Load profile

Action	Category	Keyboard	Throttle - HOTAS...	Saitek Pro Flight ...	Joystick - HOTAS ...	TI
Engine RPM / Propeller Pitch (analog)	Engine Controls		JOY_SLIDER1			
Fuel Booster Pump Rheostat (analog)						
Head Tracker : Forward/Backward						TI
Head Tracker : Pitch						TI
Head Tracker : Right/Left						TI
Head Tracker : Roll						TI
Head Tracker : Up/Down						TI
Head Tracker : Yaw						TI
Instrument Light (analog)						
Instrument UV Left Light (analog)						
K-14 Brightness						
K-14 Range to target						
K-14 Target span						
Landing Flaps (analog)	Flight Control					
Mixture (analog)	Engine Controls					
Pitch						JOY_Y
Radio Volume (analog)	VHF Radio					
Roll						JOY_X
Rudder				JOY_RZ		
Tail Wheel Lock (analog)	Flight Control, Systems					
TDC Slew Horizontal (mouse)						
TDC Slew Vertical (mouse)						
Throttle (analog)	Engine Controls		JOY_Z			
Throttle Friction (analog)	Engine Controls					

Modifiers Add Clear Default **Axis Assign** Axis Tune FF Tune Make HTML

CANCEL OK

To assign an axis, click on "AXIS ASSIGN". You can also select "AXIS COMMANDS" in the upper scrolling menu.

To modify curves and sensitivities of axes, click on the axis you want to modify and then click on "AXIS TUNE".

In the “Special” menu in Options, select the P-47D-30 menu. Make sure to have Takeoff Assist set to “0” (turned off). By default it is set to 100 (ON). This will cause you to crash and burn inexplicably during takeoff. Also uncheck the Auto-Rudder box.

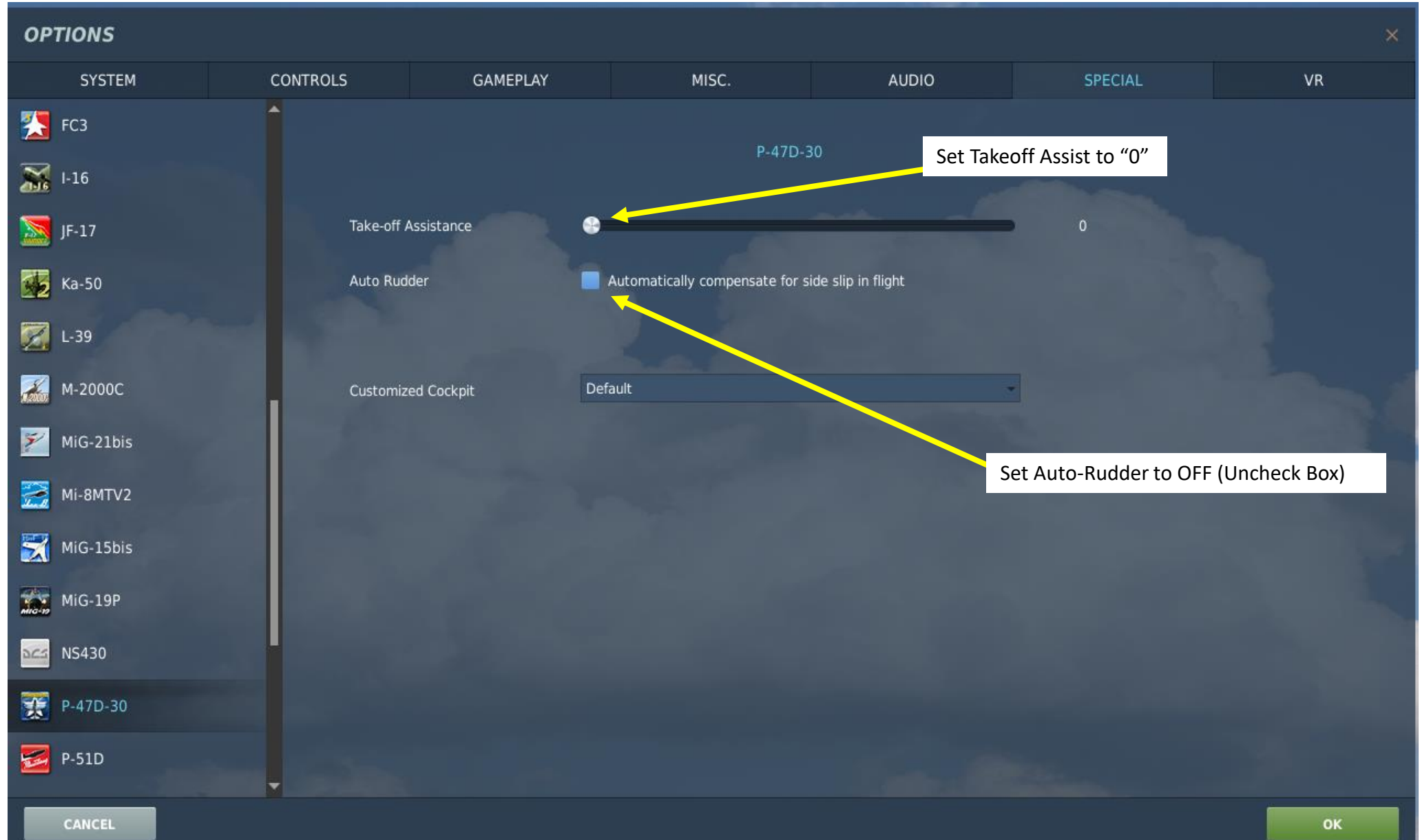

Bind the following axes:

- Pitch, Roll, Rudder (Deadzone at 0, Saturation X at 100, Saturation Y at 100, Curvature at 0)
- Throttle – Controls Manifold Pressure
- Engine RPM / Propeller Pitch (P)
- Boost (B) – Controls Turbosupercharger
- Wheel Brake Left
- Wheel Brake Right

When setting wheel brake axis, the axis is not set to “Invert” by default. You need to click on “Invert” in the “Axis Tune” menu for each wheel brake.

OPTIONS

SYSTEM: P-47D-30 Sim CONTROLS: Axis Commands GAMEPLAY: Foldable view MISC.: Reset category to default AUDIO: Clear category SPECIAL: Save profile as VR: Load profile

Action	Category	Keyboard	Throttle - HOTAS...	Saitek Pro Flight ...	Joystick - HOTAS ...
Instrument Light (analog)					
Instrument UV Left Light (analog)					
K-14 Brightness					
K-14 Range to target					
K-14 Target span					
Landing Flaps (analog)	Flight Control				
Mixture (analog)	Engine Controls				
Pitch					JOY_Y
Radio Volume (analog)	VHF Radio				
Roll					JOY_X
Rudder				JOY_RZ	
Tail Wheel Lock (analog)	Flight Control, Systems				
TDC Slew Horizontal (mouse)					
TDC Slew Vertical (mouse)					
Throttle (analog)	Engine Controls		JOY_Z		
Throttle Friction (analog)	Engine Controls				
Trim Aileron (analog)	Flight Control				
Trim Elevator (analog)	Flight Control				
Trim Rudder (analog)	Flight Control				
Undercarriage (analog)	Systems, Hydraulic system				
Wheel brake Both (analog)	Flight Control, Systems				
Wheel brake Left (analog)	Flight Control, Systems			JOY_X	
Wheel brake Right (analog)	Flight Control, Systems			JOY_Y	
Zoom View					

Buttons: Modifiers, Add, Clear, Default, Axis Assign, Axis Tune, FF Tune, Make HTML, CANCEL, OK

AXIS TUNE PANEL

Deadzone: 0

Saturation X: 100

Saturation Y: 100

Curvature: 0

Slider
 Invert
 User Curve

Axis Tune: JOY_X

Buttons: CANCEL, RESET, OK



Aeroplane, November 1999

Republic P-47 Thunderbolt

This cutaway of the Republic P-47D Thunderbolt was produced for RAF Flying Review, and appeared in the July 1963 issue.

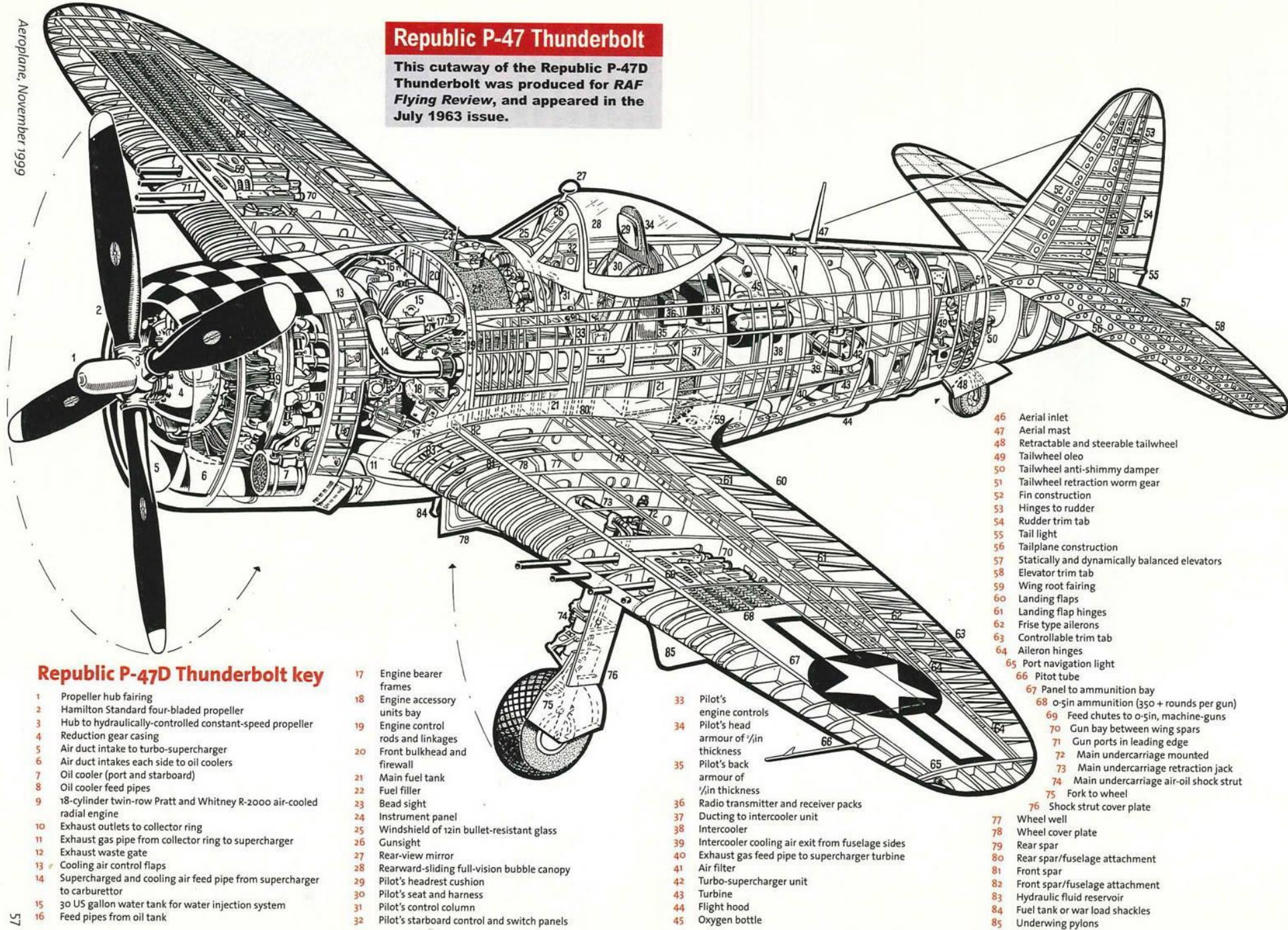

Republic P-47D Thunderbolt key

- 1 Propeller hub fairing
- 2 Hamilton Standard four-bladed propeller
- 3 Hub to hydraulically-controlled constant-speed propeller
- 4 Reduction gear casing
- 5 Air duct intake to turbo-supercharger
- 6 Air duct intakes each side to oil coolers
- 7 Oil cooler (port and starboard)
- 8 Oil cooler feed pipes
- 9 18-cylinder twin-row Pratt and Whitney R-2000 air-cooled radial engine
- 10 Exhaust outlets to collector ring
- 11 Exhaust gas pipe from collector ring to supercharger
- 12 Exhaust waste gate
- 13 Cooling air control flaps
- 14 Supercharged and cooling air feed pipe from supercharger to carburettor
- 15 30 US gallon water tank for water injection system
- 16 Feed pipes from oil tank

- 17 Engine bearer frames
- 18 Engine accessory units bay
- 19 Engine control rods and linkages
- 20 Front bulkhead and firewall
- 21 Main fuel tank
- 22 Fuel filler
- 23 Bead sight
- 24 Instrument panel
- 25 Windshield of 12in bullet-resistant glass
- 26 Gun sight
- 27 Rear-view mirror
- 28 Rearward-sliding full-vision bubble canopy
- 29 Pilot's headrest cushion
- 30 Pilot's seat and harness
- 31 Pilot's control column
- 32 Pilot's starboard control and switch panels

- 33 Pilot's engine controls
- 34 Pilot's head armour of 1/2in thickness
- 35 Pilot's back armour of 1/2in thickness
- 36 Radio transmitter and receiver packs
- 37 Ducting to intercooler unit
- 38 Intercooler
- 39 Intercooler cooling air exit from fuselage sides
- 40 Exhaust gas feed pipe to supercharger turbine
- 41 Air filter
- 42 Turbo-supercharger unit
- 43 Turbine
- 44 Flight hood
- 45 Oxygen bottle

- 46 Aerial inlet
- 47 Aerial mast
- 48 Retractable and steerable tailwheel
- 49 Tailwheel oleo
- 50 Tailwheel anti-shimmy damper
- 51 Tailwheel retraction worm gear
- 52 Fin construction
- 53 Hinges to rudder
- 54 Rudder trim tab
- 55 Tail light
- 56 Tailplane construction
- 57 Statically and dynamically balanced elevators
- 58 Elevator trim tab
- 59 Wing root fairing
- 60 Landing flaps
- 61 Landing flap hinges
- 62 Frise type ailerons
- 63 Controllable trim tab
- 64 Aileron hinges
- 65 Port navigation light
- 66 Pitot tube
- 67 Panel to ammunition bay
- 68 0.5in ammunition (350 + rounds per gun)
- 69 Feed chutes to 0.5in, machine-guns
- 70 Gun bay between wing spars
- 71 Gun ports in leading edge
- 72 Main undercarriage mounted
- 73 Main undercarriage retraction jack
- 74 Main undercarriage air-oil shock strut
- 75 Fork to wheel
- 76 Shock strut cover plate
- 77 Wheel well
- 78 Wheel cover plate
- 79 Rear spar
- 80 Rear spar/fuselage attachment
- 81 Front spar
- 82 Front spar/fuselage attachment
- 83 Hydraulic fluid reservoir
- 84 Fuel tank or war load shackles
- 85 Underwing pylons

PART 3 – COCKPIT & EQUIPMENT

P-47D THUNDERBOLT



Tip: Pilot body can be toggled ON/OFF with "RSHIFT+P"



P-47D
THUNDERBOLT

PART 3 - COCKPIT & EQUIPMENT



Carburetor Air Heat Control Cable

Carburetor Air Heat Control Lever

Used to provide additional hot air to the carburetor in cold weather or icing conditions

- FWD: Cold
- AFT: Hot

Rudder Control Cable

Air Filter Control Cable

Air Filter Control Lever

Controls the air supply to the cabin through a dust filter and is used in dusty conditions

- FWD: ON
- AFT: OFF

Bomb Arming Levers

Turn Counter-clockwise and pull, then turn clockwise to arm.

- BELLY / LEFT / RIGHT Bomb Rack

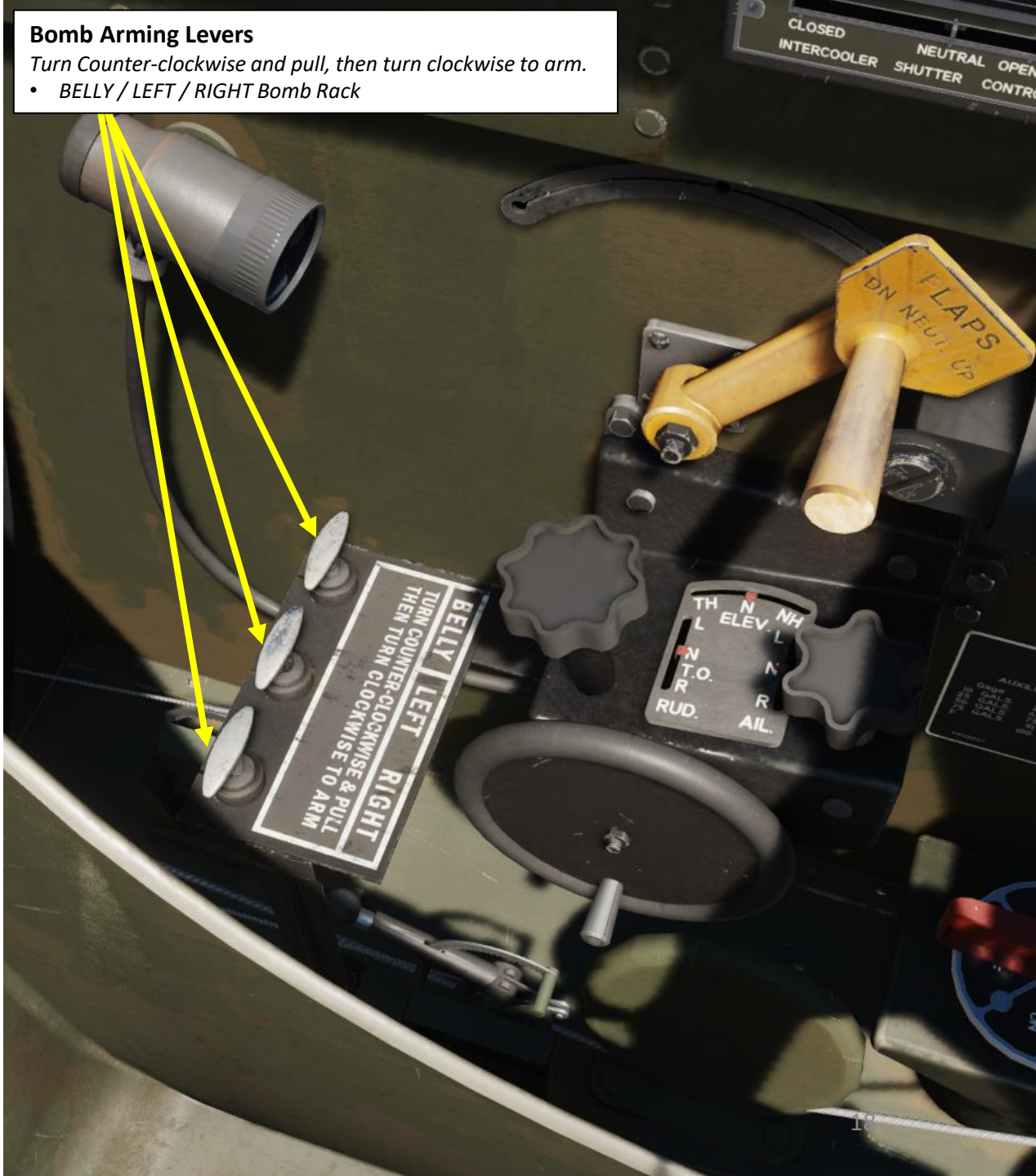
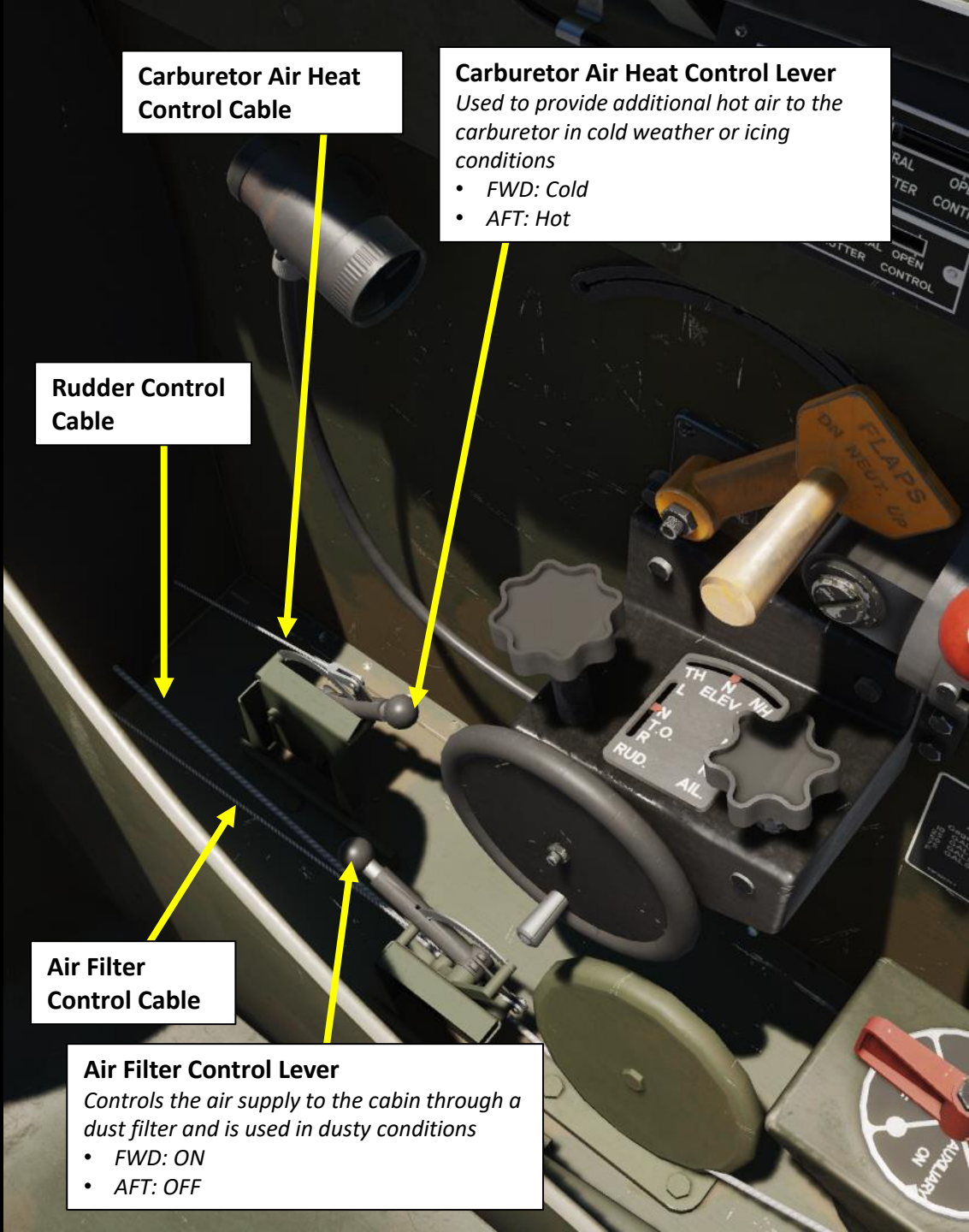

Cockpit Spot Light Lamp
Rotate to adjust intensity

Flaps Lever

- FWD: Flaps UP
- MIDDLE: Neutral
- AFT: Flaps DOWN

Landing Gear Button
Button needs to be pressed IN to allow gear lever movement

Landing Gear Lever

- UP: Gear UP
- DOWN: Gear DOWN

Landing Gear Lever Safety Latch

FUEL TANK CALIBRATION			
AUXILIARY		MAIN	
Gage	Actual	Gage	Actual
10 GALS	25 GALS	0 GALS	0-27 GALS
25 GALS	47 GALS	40 GALS	54 GALS
50 GALS	78 GALS	100 GALS	107 GALS
75 GALS	110 GALS	150 GALS	157 GALS
100 GALS	142 GALS	200 GALS	203 GALS
		250 GALS	243 GALS
		300 GALS	283 GALS

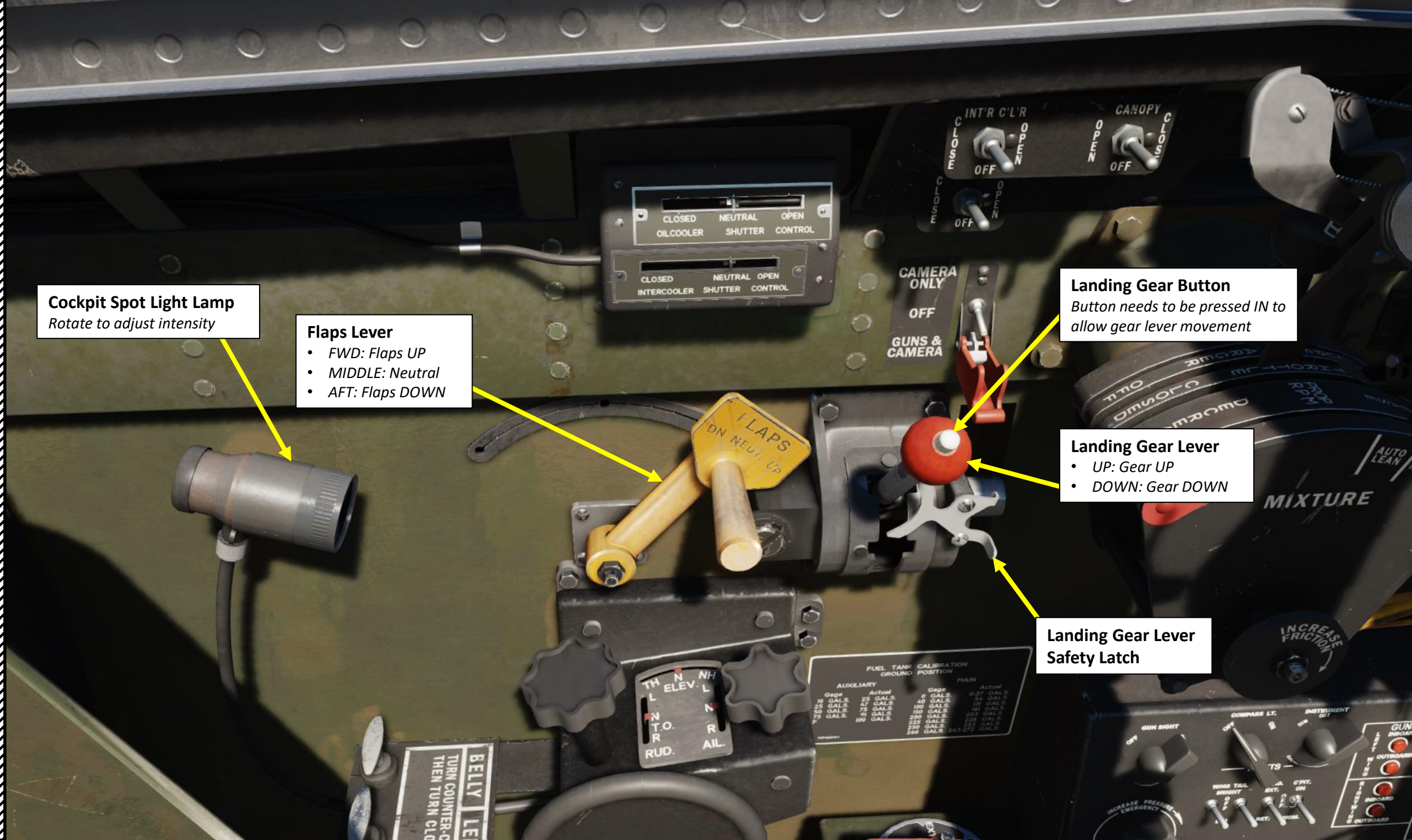

Oil Cooler Shutters
Position Indicator

Intercooler Shutters
Position Indicator

Intercooler Shutters Control Switch

- FWD: Opens Shutters
- MIDDLE: Shutters remain in current position
- AFT: Closes Shutters

Oil Cooler Shutters Control Switch

- FWD: Opens Shutters
- MIDDLE: Shutters remain in current position
- AFT: Closes Shutters

FUEL TANK CALIBRATION GROUND POSITION			
AUXILIARY		MAIN	
Gage	Actual	Gage	Actual
0	0 GALS.	0	0 GALS.
10	25 GALS.	10	25 GALS.
20	50 GALS.	20	50 GALS.
30	75 GALS.	30	75 GALS.
40	100 GALS.	40	100 GALS.
50	125 GALS.	50	125 GALS.
60	150 GALS.	60	150 GALS.
70	175 GALS.	70	175 GALS.
80	200 GALS.	80	200 GALS.
90	225 GALS.	90	225 GALS.
100	250 GALS.	100	250 GALS.
		110	275 GALS.
		120	300 GALS.
		130	325 GALS.
		140	350 GALS.
		150	375 GALS.
		160	400 GALS.
		170	425 GALS.
		180	450 GALS.
		190	475 GALS.
		200	500 GALS.

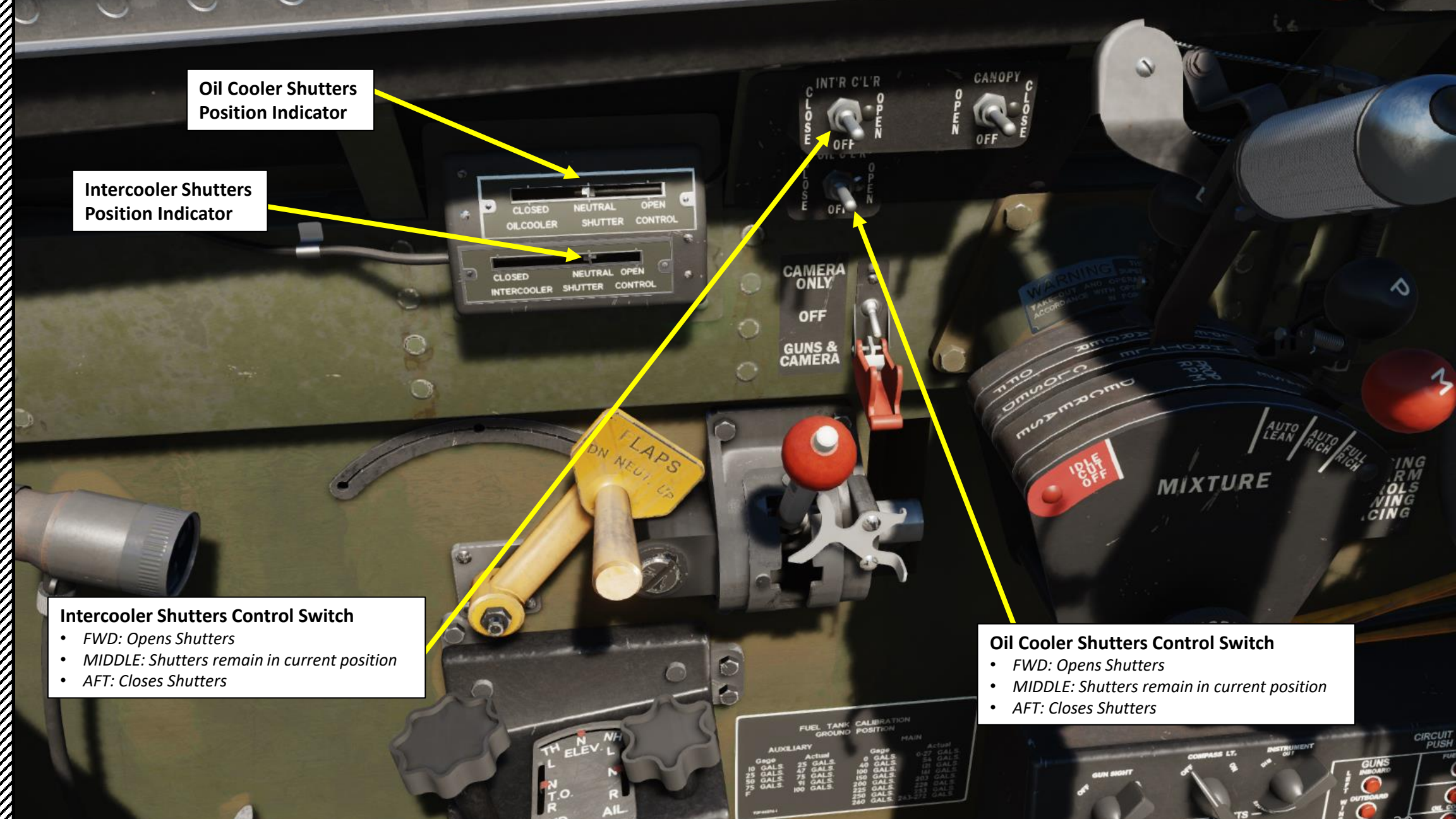

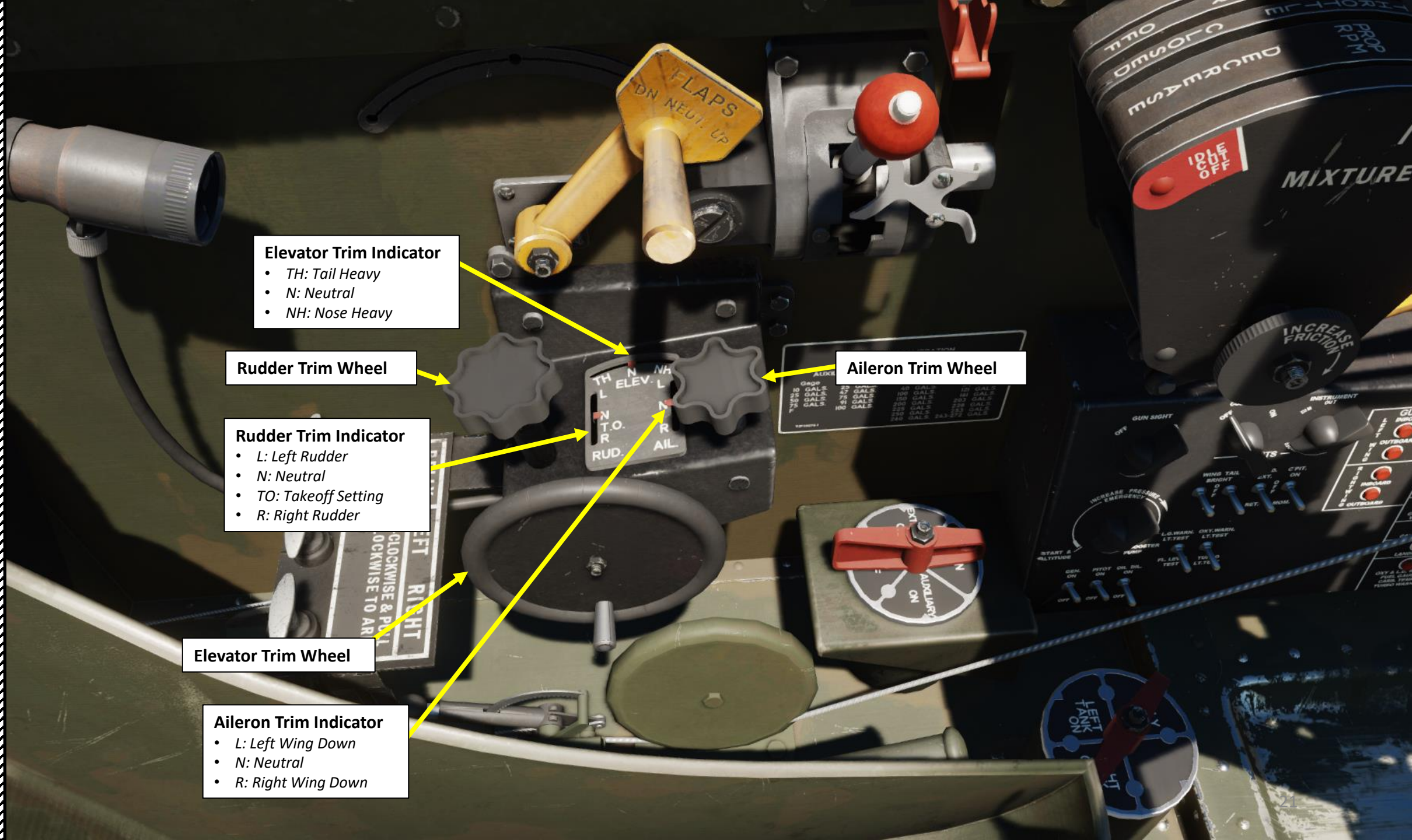

Elevator Trim Indicator

- TH: Tail Heavy
- N: Neutral
- NH: Nose Heavy

Rudder Trim Wheel

Rudder Trim Indicator

- L: Left Rudder
- N: Neutral
- TO: Takeoff Setting
- R: Right Rudder

Elevator Trim Wheel

Aileron Trim Indicator

- L: Left Wing Down
- N: Neutral
- R: Right Wing Down

Aileron Trim Wheel

ALUXE

0gals	25 GALS	50 GALS	75 GALS
10 GALS	35 GALS	60 GALS	85 GALS
20 GALS	45 GALS	70 GALS	95 GALS
30 GALS	55 GALS	80 GALS	100 GALS

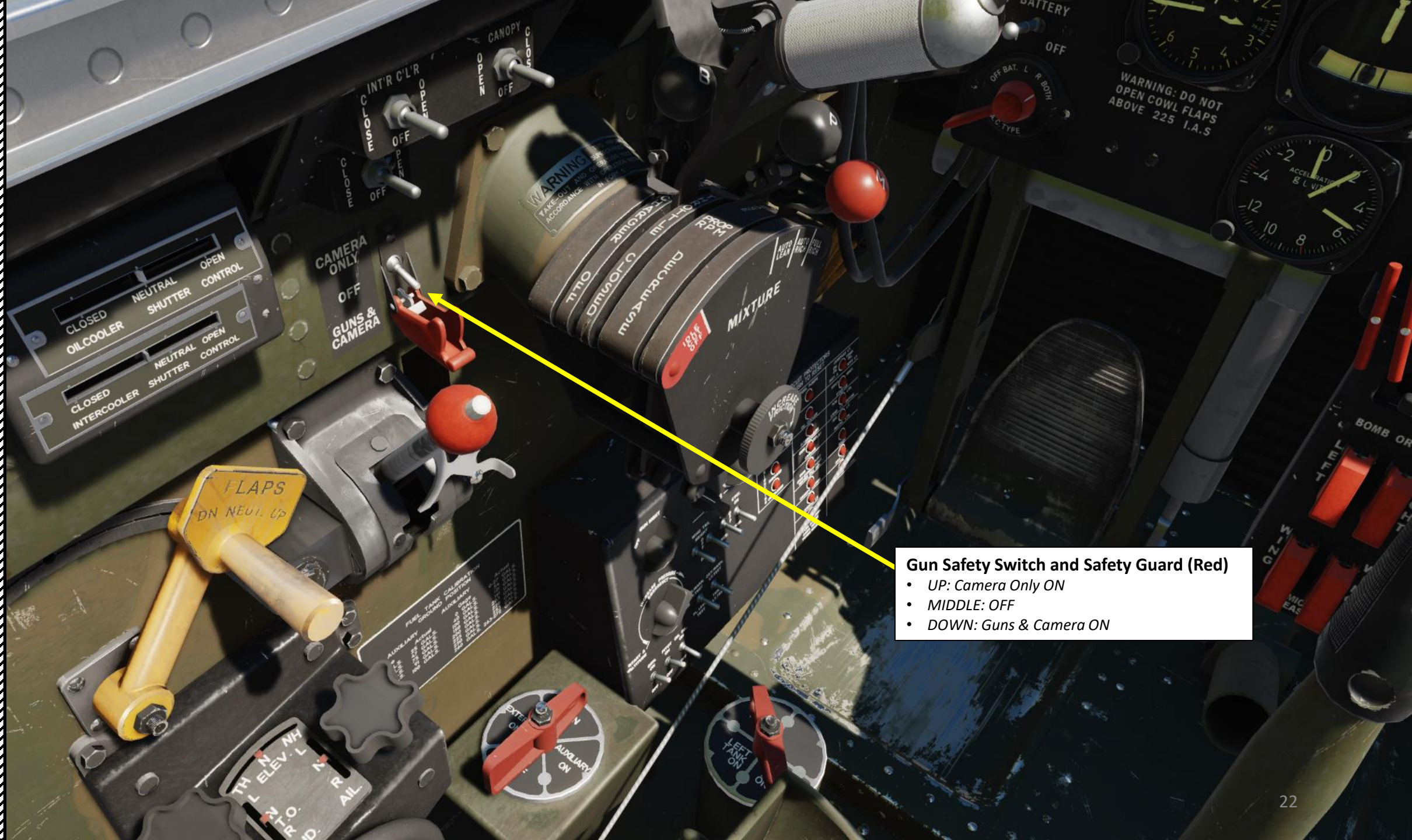

Gun Safety Switch and Safety Guard (Red)

- UP: Camera Only ON
- MIDDLE: OFF
- DOWN: Guns & Camera ON

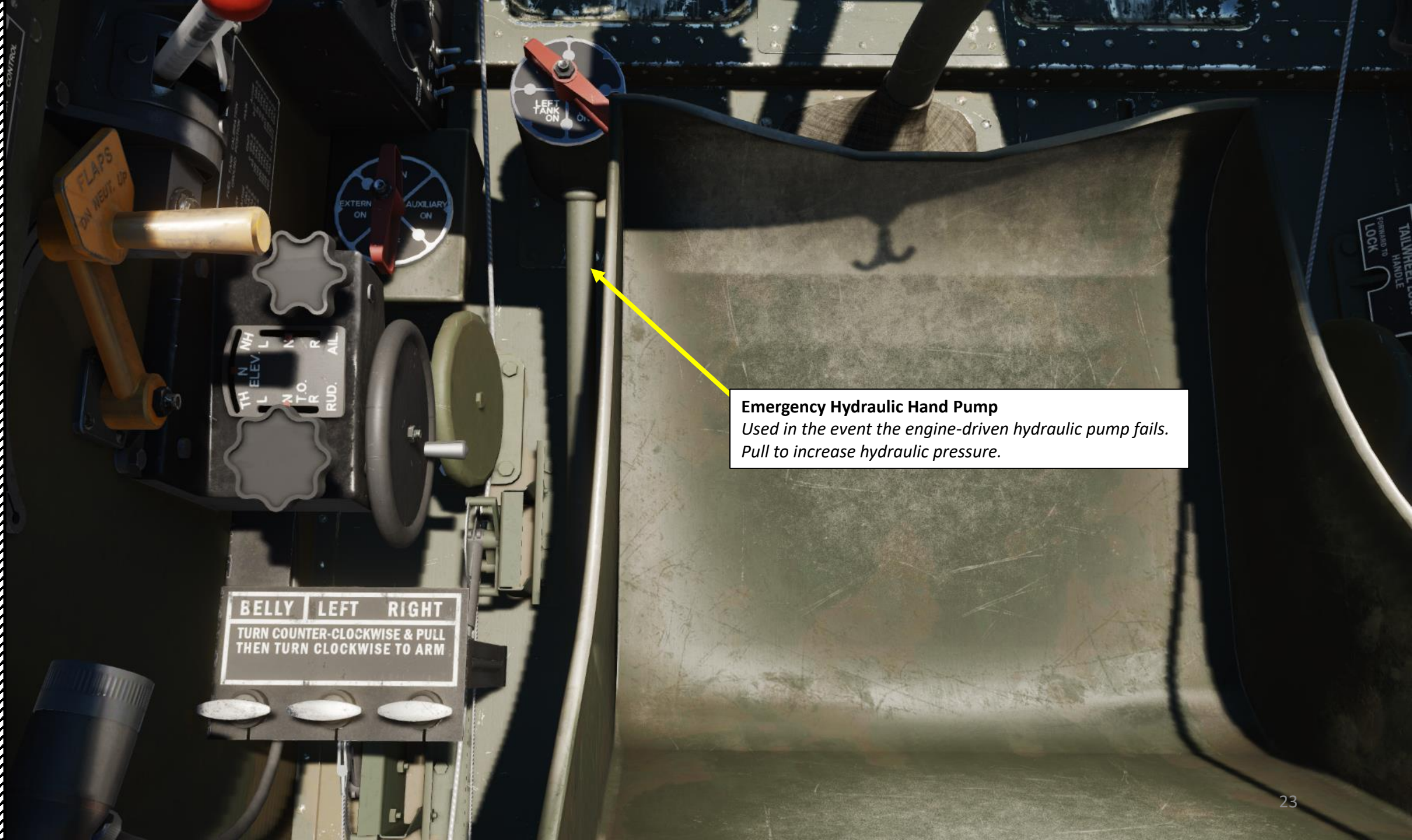

Emergency Hydraulic Hand Pump
*Used in the event the engine-driven hydraulic pump fails.
Pull to increase hydraulic pressure.*

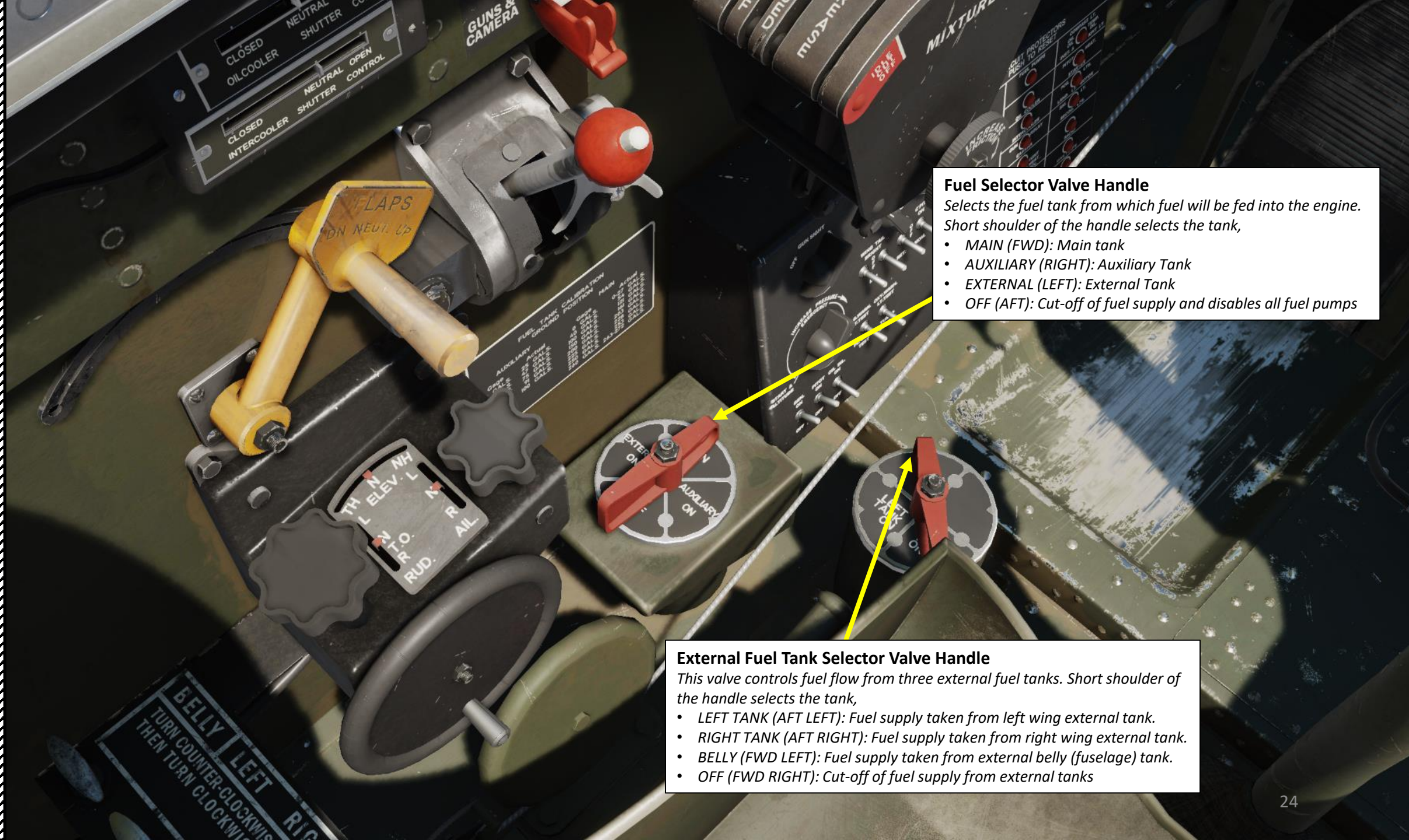

Fuel Selector Valve Handle

Selects the fuel tank from which fuel will be fed into the engine. Short shoulder of the handle selects the tank,

- MAIN (FWD): Main tank
- AUXILIARY (RIGHT): Auxiliary Tank
- EXTERNAL (LEFT): External Tank
- OFF (AFT): Cut-off of fuel supply and disables all fuel pumps

External Fuel Tank Selector Valve Handle

This valve controls fuel flow from three external fuel tanks. Short shoulder of the handle selects the tank,

- LEFT TANK (AFT LEFT): Fuel supply taken from left wing external tank.
- RIGHT TANK (AFT RIGHT): Fuel supply taken from right wing external tank.
- BELLY (FWD LEFT): Fuel supply taken from external belly (fuselage) tank.
- OFF (FWD RIGHT): Cut-off of fuel supply from external tanks

Fuel Tank Calibration Ground Position Table

AUXILIARY		MAIN	
Gage	Actual	Gage	Actual
10 GALS.	25 GALS.	0 GALS.	0-27 GALS.
25 GALS.	47 GALS.	40 GALS.	54 GALS.
50 GALS.	75 GALS.	100 GALS.	121 GALS.
75 GALS.	91 GALS.	150 GALS.	161 GALS.
F	100 GALS.	200 GALS.	203 GALS.
		225 GALS.	228 GALS.
		250 GALS.	253 GALS.
		260 GALS.	263-272 GALS.

FUEL TANK CALIBRATION GROUND POSITION			
AUXILIARY		MAIN	
GAGE	ACTUAL	GAGE	ACTUAL
10 gals	25 gals	0 gals	0-27 gals
25 gals	47 gals	40 gals	54 gals
50 gals	75 gals	100 gals	121 gals
75 gals	91 gals	150 gals	161 gals
F (Full)	100 gals	200 gals	203 gals
		225 gals	228 gals
		250 gals	253 gals
		260 gals	263-272 gals



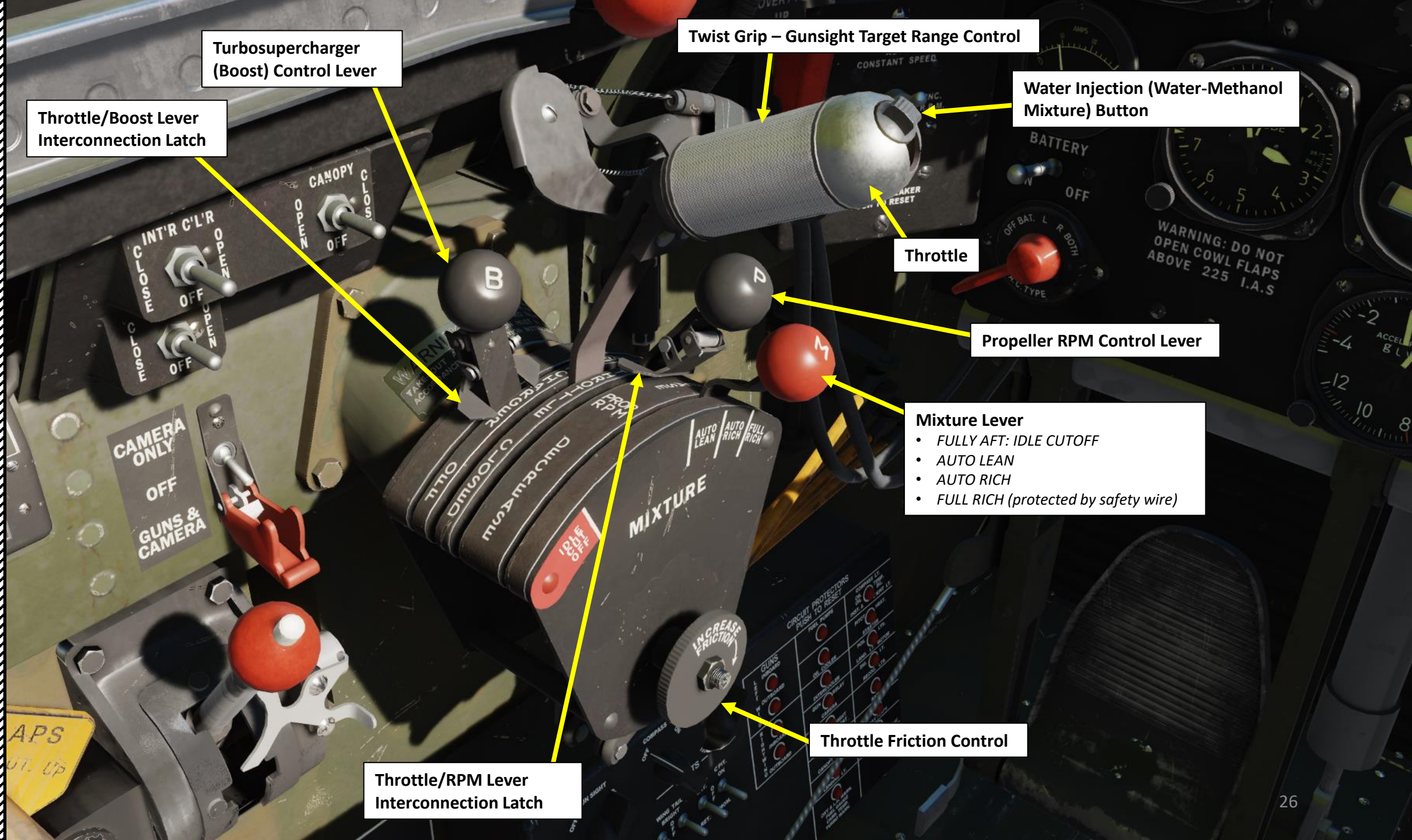

Turbosupercharger (Boost) Control Lever

Throttle/Boost Lever Interconnection Latch

Twist Grip – Gunsight Target Range Control

Water Injection (Water-Methanol Mixture) Button

Throttle

Propeller RPM Control Lever

Mixture Lever

- FULLY AFT: IDLE CUTOFF
- AUTO LEAN
- AUTO RICH
- FULL RICH (protected by safety wire)

Throttle Friction Control

Throttle/RPM Lever Interconnection Latch

FUEL TANK CALIBRATION GROUND POSITION			
AUXILIARY		MAIN	
Gage	Actual	Gage	Actual
25 GALS.	40 GALS.	0-27	GALS.
47 GALS.	100 GALS.	54	GALS.
75 GALS.	150 GALS.	121	GALS.
91 GALS.	200 GALS.	161	GALS.
100 GALS.	225 GALS.	203	GALS.
	250 GALS.	228	GALS.
	260 GALS.	253	GALS.
		263-272	GALS.

**CIRCUIT PROTECTORS
PUSH TO RESET**

FUEL PUMPS

GUNS
INBOARD
OUTBOARD
LEFT WING
RIGHT WING
INBOARD
OUTBOARD

OIL COOLER
INTERCOOLER
GUN CAMERA
RIGHT WING CAMERA HEAT
WATER INJ. SOL.
CANDY MOTOR
LANDING LT.
OXY & L.G. WARN. FUEL GAUGE CARB. TEMP. TURBO WARN.

COMPASS LT. INSTR. & C'PT. LT. TEMP. DIL. C'PT. LT. HEAT.
PITOT
STARTER
POS. LTS.
LAND. LIGHTS
RECOG. LTS.
RADIO
DIVE FLAPS
BOMBS & TANK RELEASE

INSTRUMENT OUT
COMPASS LT. OFF ON
GUN SIGHT OFF
WING TAIL BRIGHT OFF
INCREASE PRESSURE EMERGENCY
FUEL BOOSTER PUMP
START & ALTITUDE
GEN. ON OFF
PITOT ON OFF
OIL DIL. ON OFF
LAND. EXT. ON OFF
C'PIT. ON OFF
FL. WARN. LT. TEST
OXY. WARN. LT. TEST
FL. LEVEL TEST
TUR. LT. TEST

Circuit Breakers/Protectors

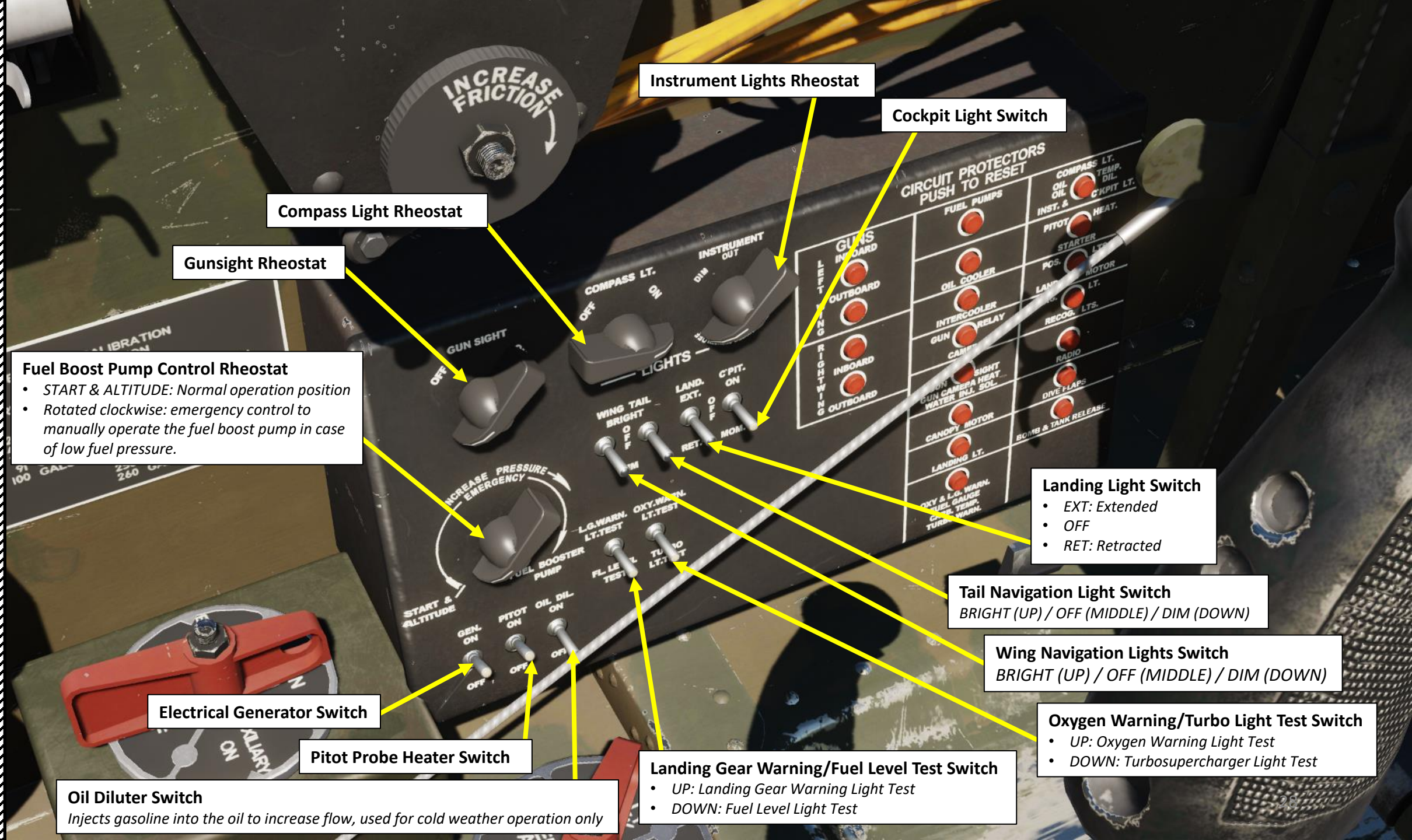

Instrument Lights Rheostat

Cockpit Light Switch

Compass Light Rheostat

Gunsight Rheostat

Fuel Boost Pump Control Rheostat

- START & ALTITUDE: Normal operation position
- Rotated clockwise: emergency control to manually operate the fuel boost pump in case of low fuel pressure.

Landing Light Switch

- EXT: Extended
- OFF
- RET: Retracted

Tail Navigation Light Switch
BRIGHT (UP) / OFF (MIDDLE) / DIM (DOWN)

Wing Navigation Lights Switch
BRIGHT (UP) / OFF (MIDDLE) / DIM (DOWN)

Oxygen Warning/Turbo Light Test Switch

- UP: Oxygen Warning Light Test
- DOWN: Turbosupercharger Light Test

Landing Gear Warning/Fuel Level Test Switch

- UP: Landing Gear Warning Light Test
- DOWN: Fuel Level Light Test

Electrical Generator Switch

Pitot Probe Heater Switch

Oil Diluter Switch
Injects gasoline into the oil to increase flow, used for cold weather operation only

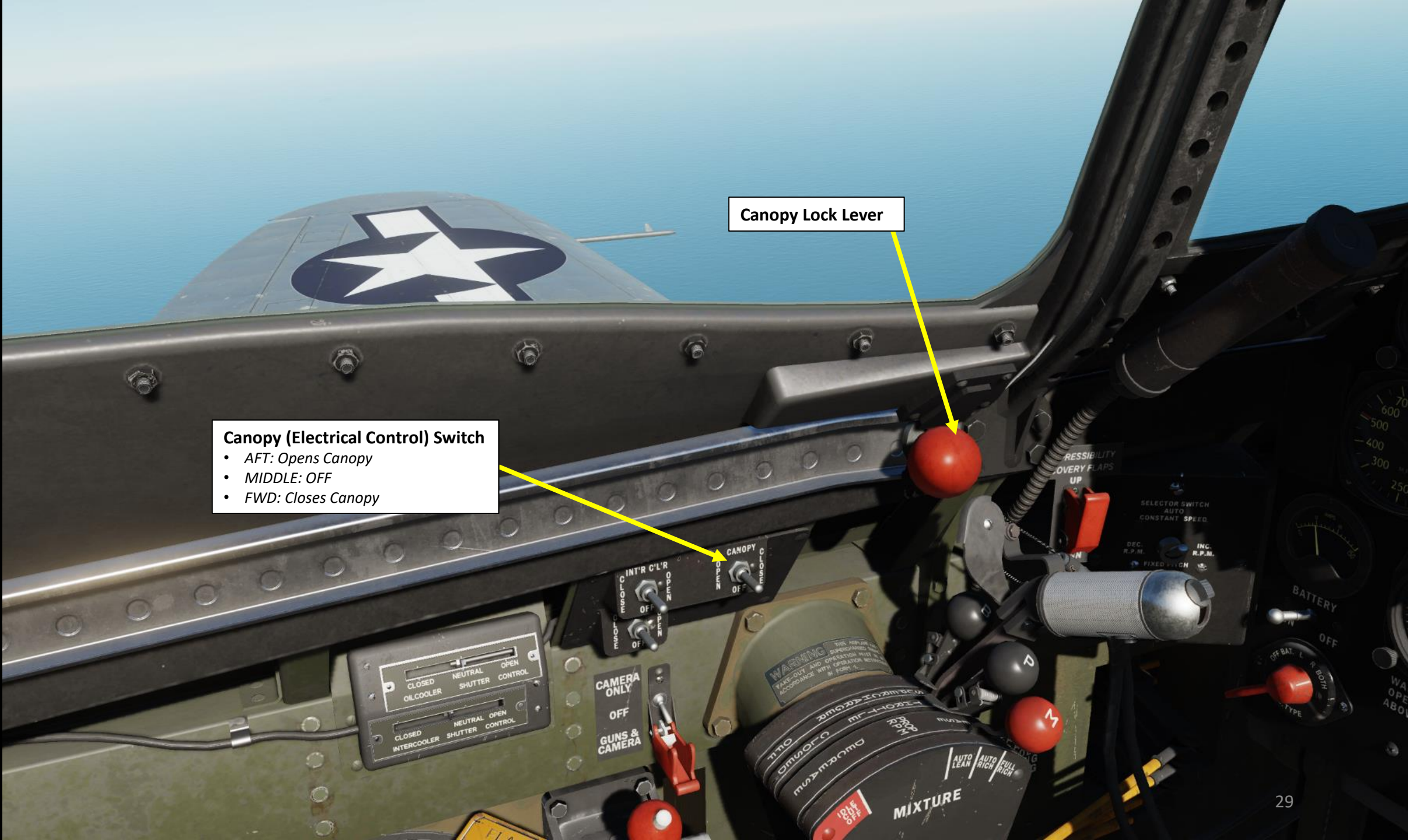

Canopy Lock Lever

Canopy (Electrical Control) Switch

- *AFT: Opens Canopy*
- *MIDDLE: OFF*
- *FWD: Closes Canopy*

Compressibility Recovery Flaps Switch

- UP: Compressibility Flaps Up/Retracted
- DOWN: Compressibility Flaps Down/Deployed

Propeller Governor Switch

- UP: Automatic Constant Speed (propeller governor automatically maintains engine rpm as set at the quadrant by, handle, marked as P – Propeller)
- DOWN: Fixed Propeller Pitch
- LEFT: Decreases propeller RPM
- RIGHT: Increases propeller RPM

Propeller Governor Circuit Breaker

Radio Push-to-Transmit Button

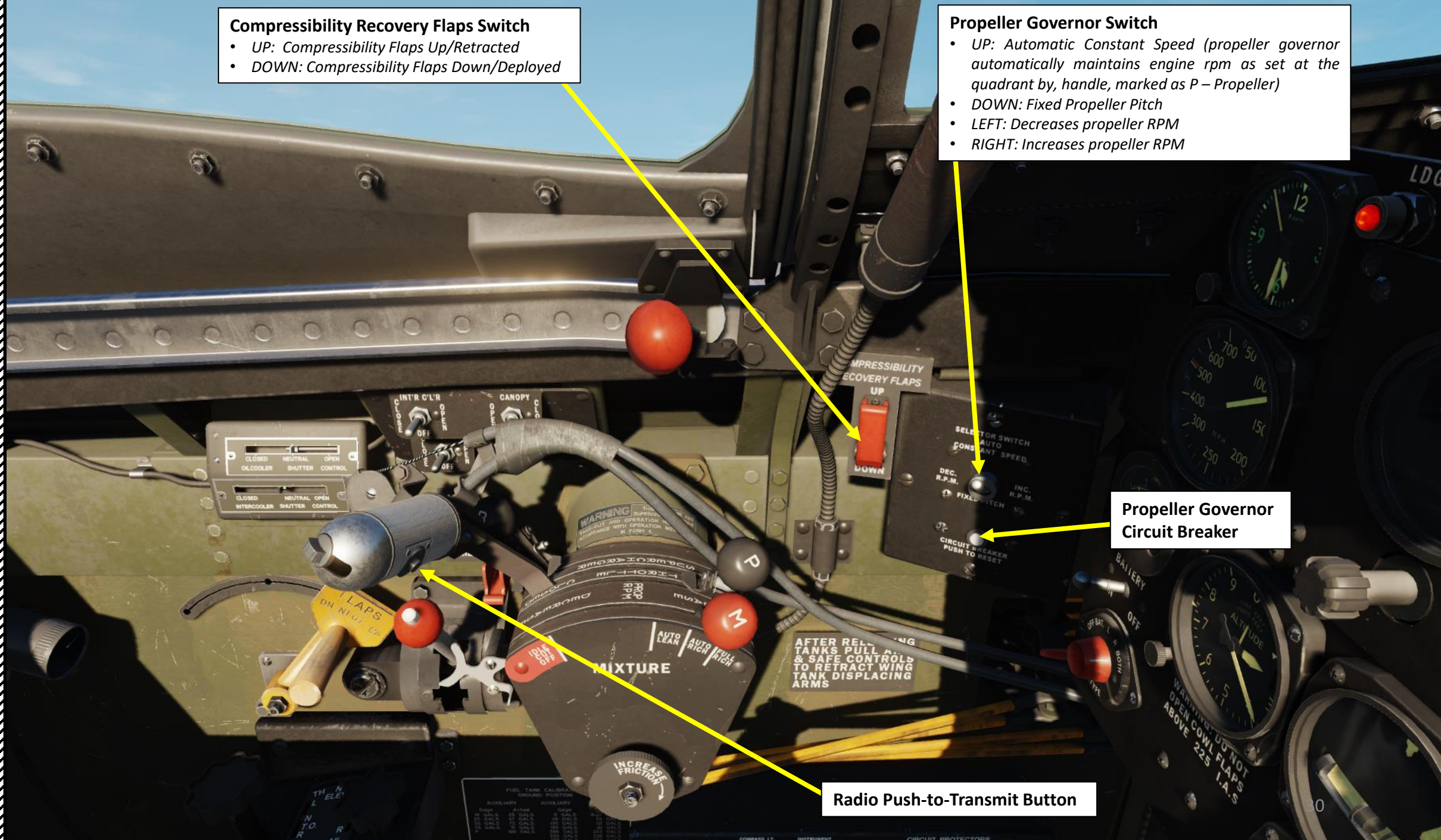



Fluorescent Cockpit Light

Fluorescent Cockpit Light

NO
HAND HOLD

LDG WARNING
LIGHT

FLAP WARNING

DO NOT LOWER FLAPS ABOVE 185 MPH
BEST SETTING FOR TAKE OFF WITH
HEAVY LOAD OR SHORT FIELD
18 TO 20 DEGREES
THIS AIRPLANE EQUIPPED WITH
JETISON CANOPY.
RECOMMEND CANOPY BE OPEN ON
TAKEOFF AND LANDING

SERVICE THE AIRPLANE
WITH 100 OCTANE FUEL
ONLY IF NOT AVAILABLE
THE NEXT HIGHER GRADE
WILL BE USED IN EMERGENCY

BATTERY

WARNING: DO NOT
OPEN COWL FLAPS
ABOVE 225 I.A.S.

FUEL LEVEL
WARN LIGHT

COWL
FLAPS
PULL TO OPEN
PUSH TO CLOSE

WARNING
RECOGNITION LIGHTS
ARE NOT TO BE
CONTINUOUSLY
ON

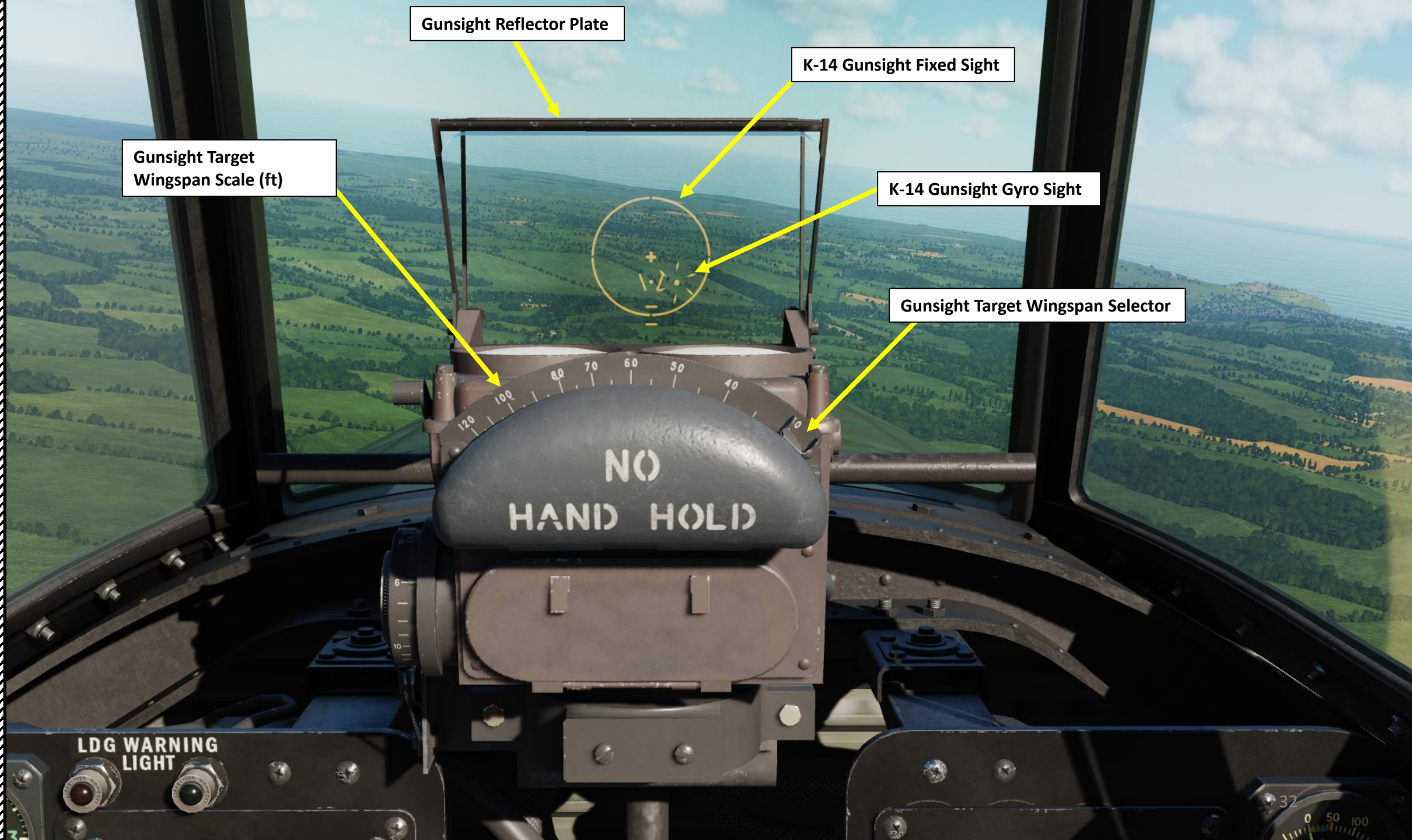

Gunsight Reflector Plate

K-14 Gunsight Fixed Sight

Gunsight Target Wingspan Scale (ft)

K-14 Gunsight Gyro Sight

Gunsight Target Wingspan Selector

LDG WARNING LIGHT

32

Gunsight Fixed Reticle Mask Lever

- UP: ON
- DOWN: OFF

NO
HAND HOLD

Gunsight Target Range Dial (x100 ft)



Canopy Jettison Emergency Handle

Landing Gear Warning Light (Red)
Illuminates when landing gears are not locked or when landing gears are not down while the throttle is 3/4 closed

Landing Gear Down & Locked Light (Green)
Illuminates when landing gears are down and locked

Clock

Winding/Adjustment Clock Knob

VNE (Do Not Exceed Speed) Index
Maximum permissible indicated airspeed of 505 mph at an altitude of 5,000 ft and less

Indicated Airspeed (IAS, in mph)

Directional Gyro

Directional Gyro Adjustment/Caging Knob

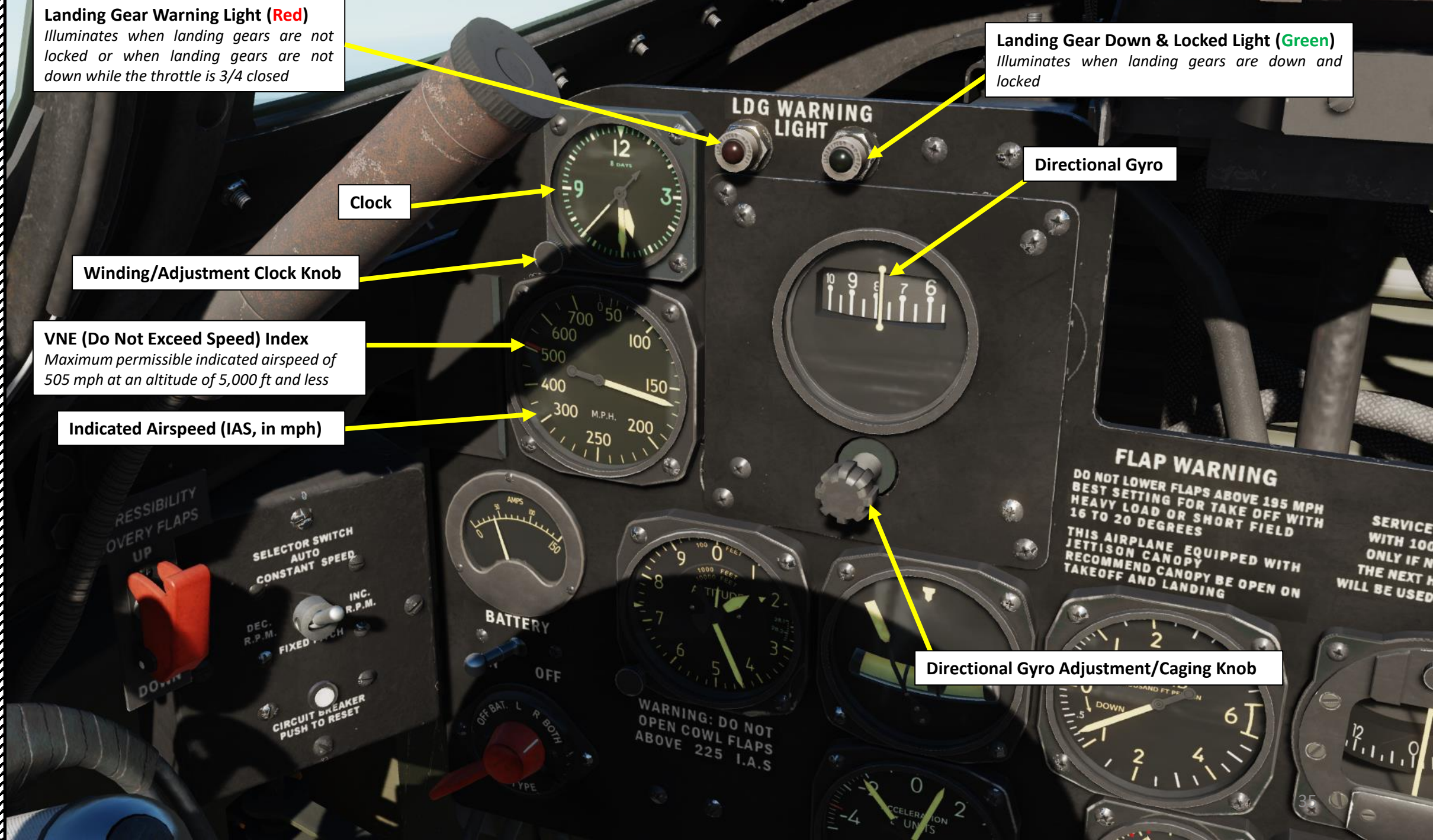

Ammeter Indicator (Amps)



Battery Switch

- LEFT: ON
- RIGHT: OFF



Magneto (Ignition) Selector Switch

- OFF: Magnetos Off
- L: Left Magneto ON Only
- R: Right Magneto ON Only
- BOTH: Both Magnetos ON



FLAP WARNING

DO NOT LOWER FLAPS ABOVE 195 MPH
BEST SETTING FOR TAKE OFF WITH
HEAVY LOAD OR SHORT FIELD
16 TO 20 DEGREES
THIS AIRPLANE EQUIPPED WITH
JETTISON CANOPY
RECOMMEND CANOPY BE OPEN ON
TAKEOFF AND LANDING

SERVICE THE AIRPLANE
WITH 100 OCTANE FUEL
ONLY IF NOT AVAILABLE
THE NEXT HIGHER GRADE
WILL BE USED IN EMERGENCY

WARNING: DO NOT
OPEN COWL FLAPS
ABOVE 225 I.A.S

BOMB OR TANK RELEASE

Altimeter (ft)

- Long Thin Needle (Outer Scale): x100 ft
- Medium Thick Needle (Middle Scale): x1,000 ft
- Short Thin Needle (Inner Scale): x10,000 ft



Barometric Pressure Setting (inches Hg)

Turn & Slip Indicator

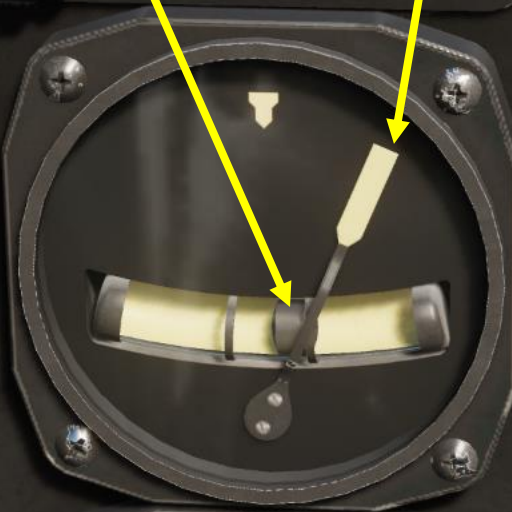

Bank Indicator



Vertical Speed Indicator/Variometer (x1000 ft per minute)



Accelerometer

(Current Acceleration in Gs)



Minimum Detected G

Maximum Detected G

Barometric Pressure Setting Adjustment Knob

Accelerometer Reset Button

FLAP WARNING

DO NOT LOWER FLAPS ABOVE 195 MPH
 BEST SETTING FOR TAKE OFF WITH
 HEAVY LOAD OR SHORT FIELD
 16 TO 20 DEGREES

SERVICE THE AIRPLANE
 WITH 100 OCTANE FUEL
 ONLY IF NOT AVAILABLE
 THE NEXT HIGHER GRADE
 WILL BE USED IN EMERGENCY

THIS AIRPLANE EQUIPPED WITH
 JETTISON CANOPY
 RECOMMEND CANOPY BE OPEN ON
 TAKEOFF AND LANDING

FUEL LEVEL WARN LIGHT

BOMB OR TANK RELEASE

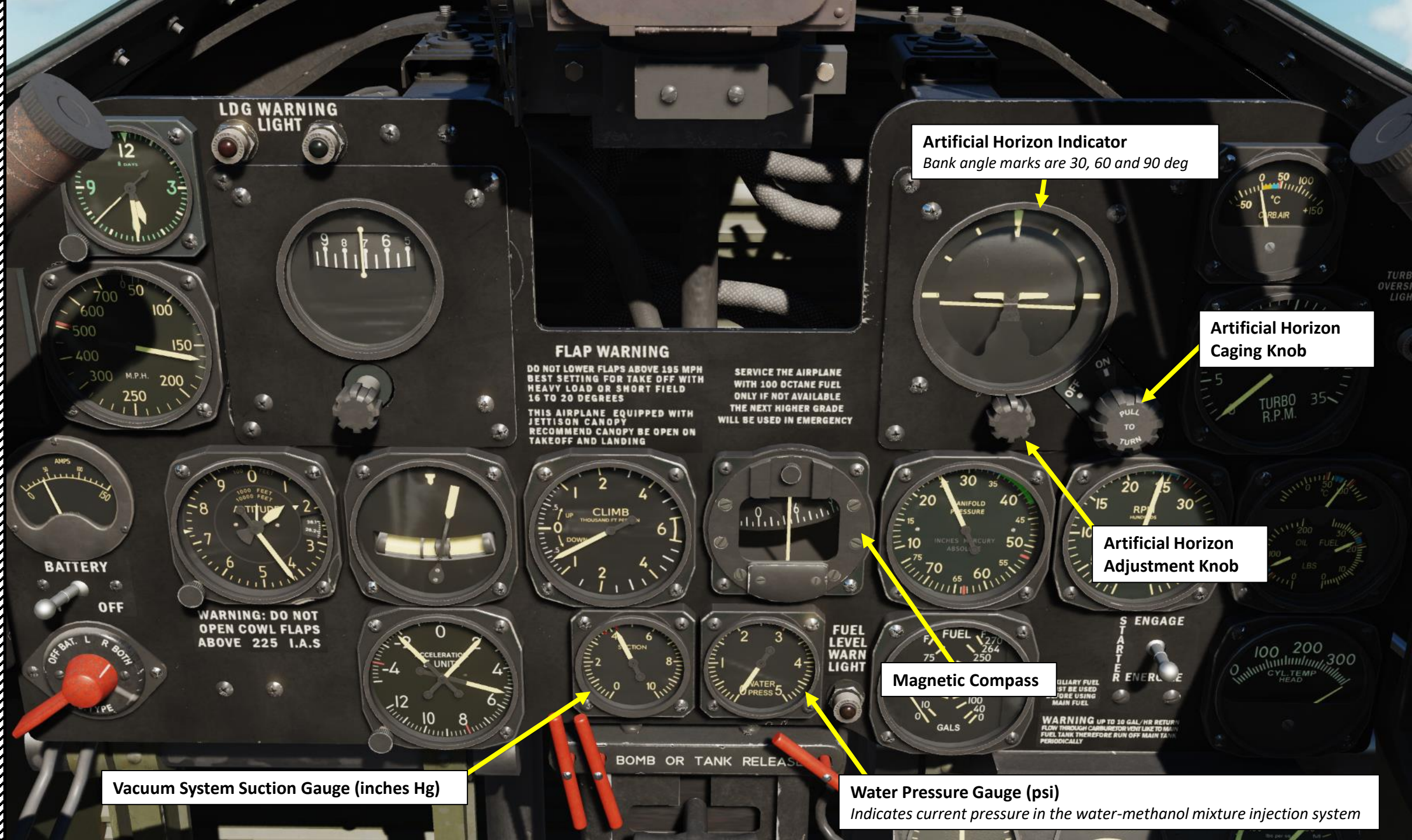

Artificial Horizon Indicator
Bank angle marks are 30, 60 and 90 deg

Artificial Horizon Caging Knob

Artificial Horizon Adjustment Knob

Magnetic Compass

Vacuum System Suction Gauge (inches Hg)

Water Pressure Gauge (psi)
Indicates current pressure in the water-methanol mixture injection system

Carburetor Air Temperature Indicator (deg C)
Operational range is in blue

Turbine Overspeed Light
Illuminates when turbosupercharger RPM exceeds 22,000

Turbosupercharger Tachometer (x1000 RPM)
Maximum allowable turbocharger RPM is 22,000

Defroster Control Lever

- Pushed IN: ON
- Pulled OUT: OFF

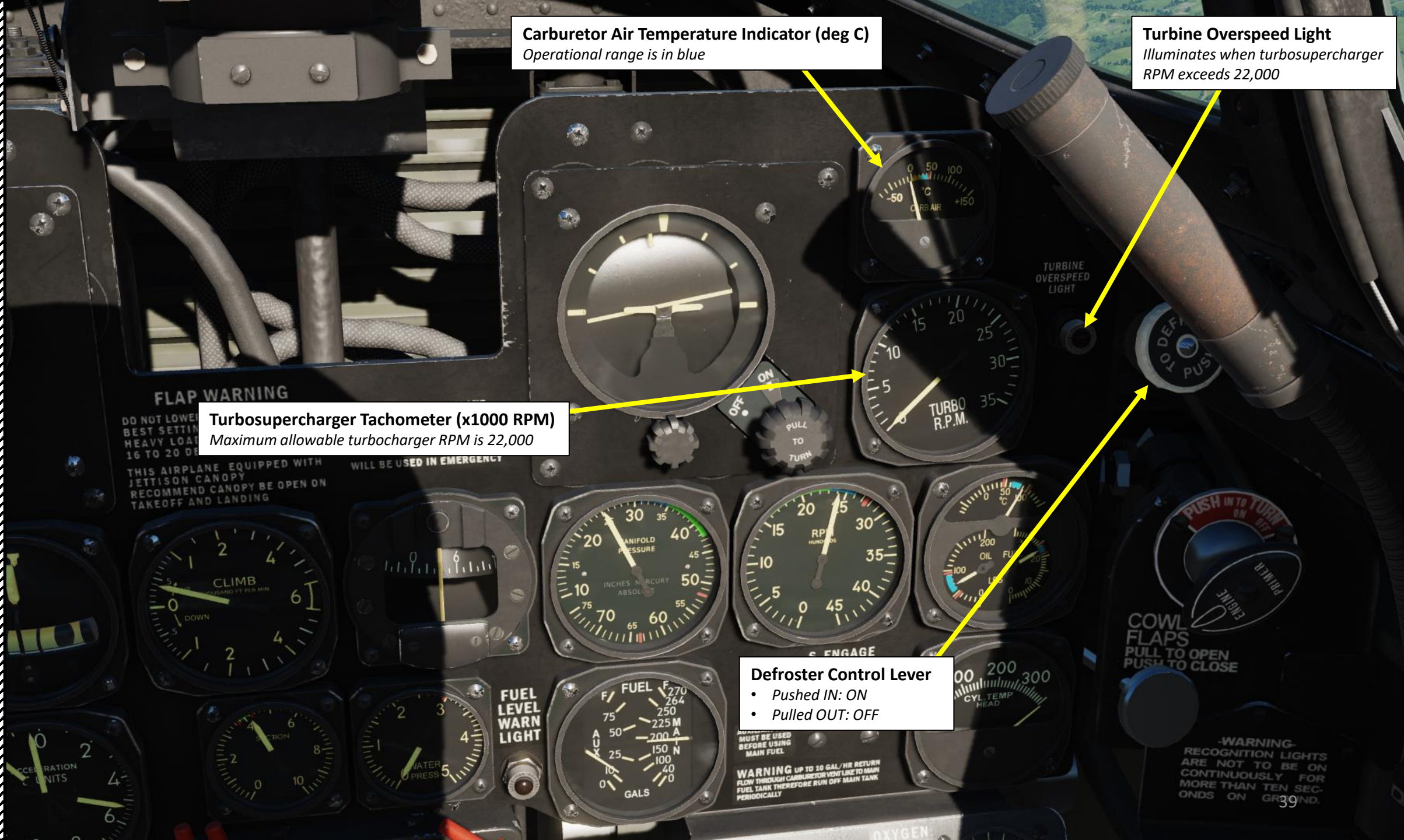

Engine Tachometer (x100 RPM)

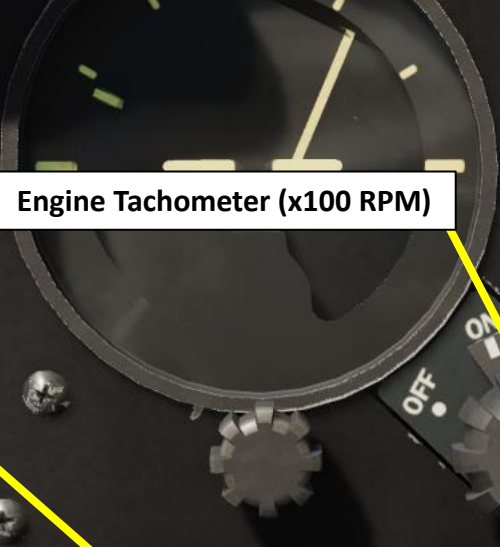

Engine Oil Temperature Indicator (deg C)



Engine Fuel Pressure Indicator (psi)



Engine Manifold Pressure Indicator (inches Hg)



Starter Switch
• UP: ENGAGE, engages flywheel with the engine
• MIDDLE: OFF
• DOWN: ENERGIZE, starts flywheel spinning

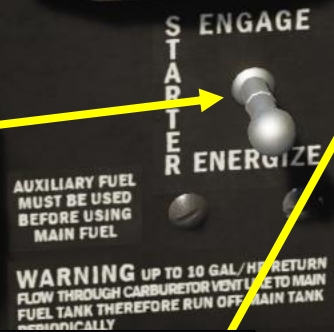

Engine Oil Pressure Indicator (psi)

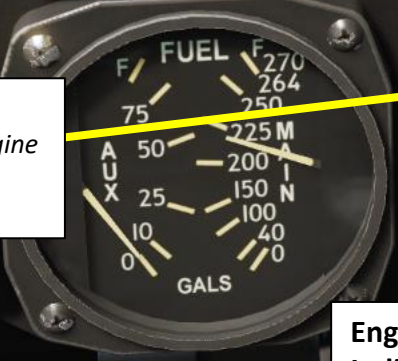

Engine CHT (Cylinder Head Temperature) Indicator (deg C)



TURBINE OVERSPEED LIGHT

COWL FLAPS PULL TO OPEN PUSH TO CLOSE

-WARNING- RECOGNITION LIGHTS ARE NOT TO BE ON CONTINUOUSLY FOR MORE THAN TEN SECONDS.

SERVICE THE AIRPLANE

WILL BE USED IN EMERGENCY

OR TANK RELEASE

OXYGEN

Auxiliary Fuel Tank Quantity Indicator (US gal)

Fuel Level Warning Light

Illuminates when fuel quantity in main tank is less than 40 US gallons

Main Fuel Tank Quantity Indicator (US gal)

FUEL LEVEL WARN LIGHT



Oxygen Pressure (psi)

Hydraulic Pressure Indicator (psi)

Oxygen Flow Blinker
Blinking indicates oxygen flow regulator is working

Low Oxygen Warning Light



Primer Handle

- 45 deg position: Locked
- Vertical position: Unlocked
- Right Click: Pushes handle IN and turns it
- Left Click: Pulls handle OUT and pushes it back IN, priming the engine

Engine Cowl Flaps Control Handle

- Pulled OUT: Opens cowl flaps
- Pushed IN: Closes cowl flaps

Recognition Lights Control Panel



Red, Green and Amber Recognition Lights

White Recognition Light Switch
White light not installed on the P-47D-25 and later variants.

Keying Switch
When Recognition Lights switches are DOWN (Keying position), pressing the Keying Switch allows you to turn them on and off as you press the Keying Switch. This can be used to send visual morse code signals.

Keying Light
Illuminates when keying switch is being pressed

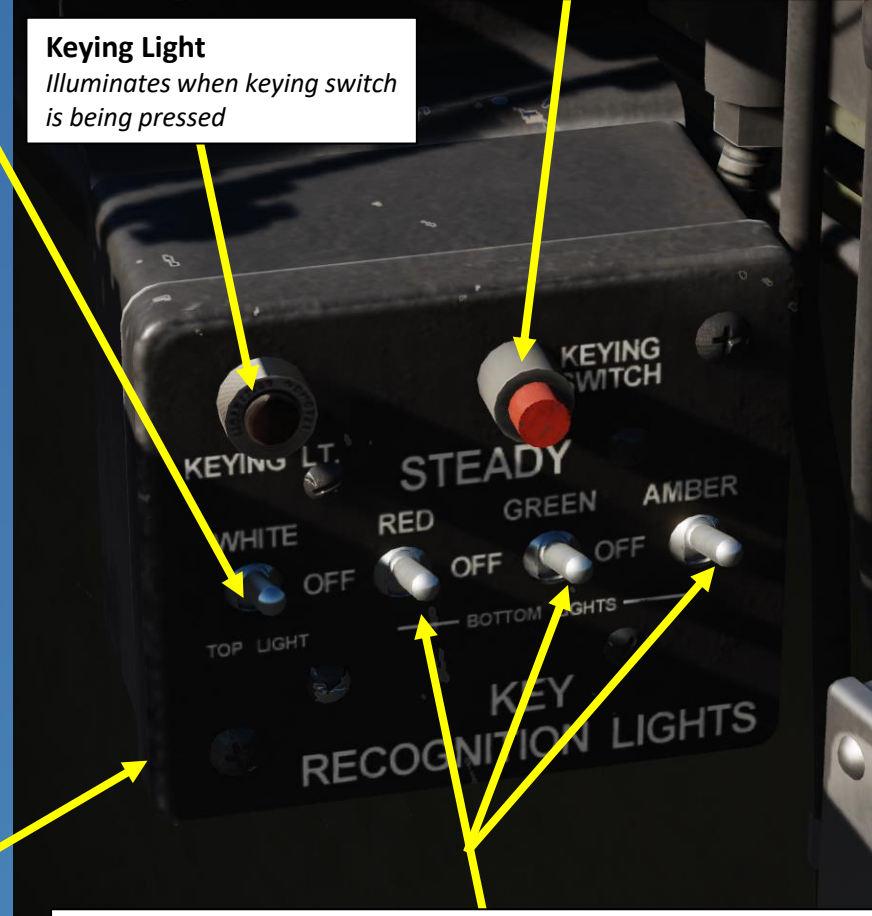

Recognition Lights Control Panel

Red, Green & Amber Recognition Lights Switches

- UP: Steady glow (ON)
- MIDDLE: OFF
- DOWN: Key position (ON when the keying switch is being pressed)

NOTE:
Do not operate the recognition lights for over 10 seconds continuously on the ground. This may result in melting the plastic lens due to heat.

Left Hardpoint Jettison Handle

Right Hardpoint Jettison Handle

Belly Hardpoint Jettison Handle

PARK BRAKE

Parking Brake Handle

- IN: OFF
- OUT: ON

Belly Bomb/Tank Arming Switch

- UP: Armed
- DOWN: Disarmed

Right Wing Bomb/Tank Arming Switch

- UP: Armed
- DOWN: Disarmed

Right Wing Chemical Tank Arming Switch

- UP: Armed
- DOWN: Disarmed

Left Wing Bomb/Tank Arming Switch

- UP: Armed
- DOWN: Disarmed

Left Wing Chemical Tank Arming Switch

- UP: Armed
- DOWN: Disarmed

Weapons (Bomb)
Release Button

Gun Trigger

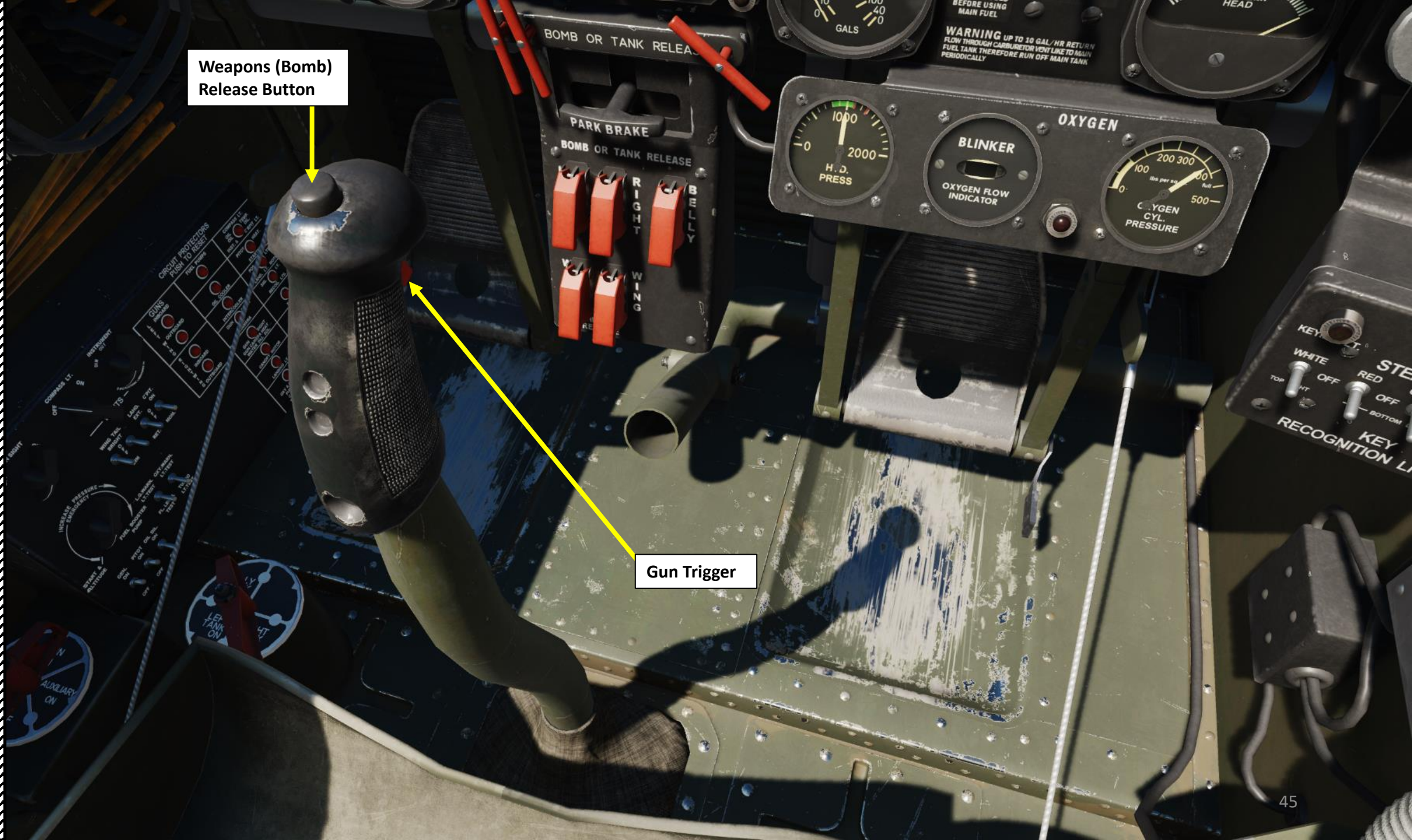



Bomb
(Right Hardpoint)

Bomb
(Belly Hardpoint)

Bomb
(Left Hardpoint)



Canopy Lock Lever

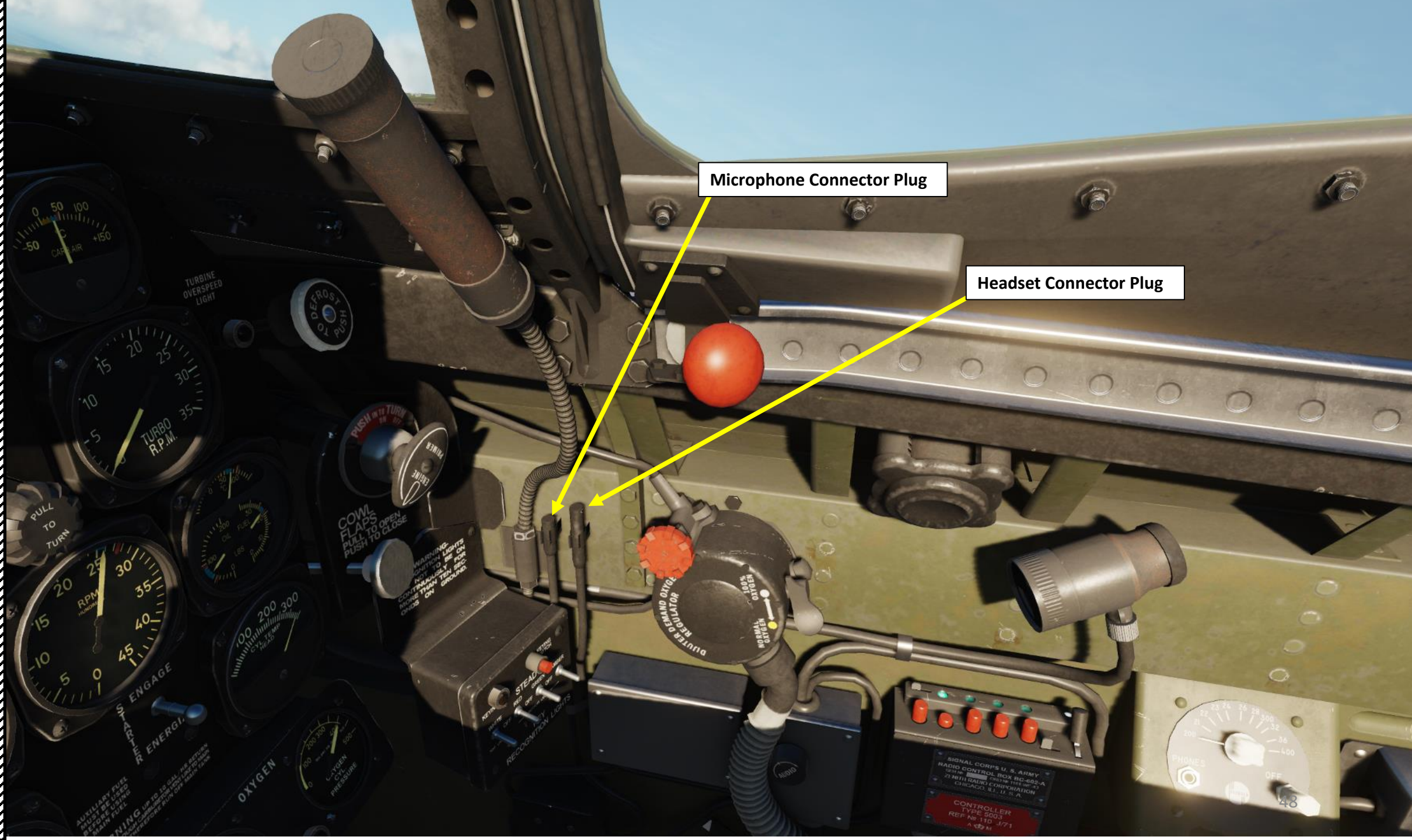

Microphone Connector Plug

Headset Connector Plug



WARNING
DO NOT OPEN
TO OPEN
TO CLOSE

WARNING
RECOGNITION LIGHTS
ARE NOT TO BE ON
CONTINUOUSLY FOR
MORE THAN TEN SEC.
ON GROUND.

KEYING SWITCH
STEADY GREEN OFF AMBER
WHITE RED OFF
TOP BOTTOM
KEY RECOGNITION LIGHTS

OUTER DEMAND OXYGEN
REGULATOR
100% OXYGEN
NORMAL OXYGEN

SIGNAL CORPS U. S. ARMY
RADIO CONTROL BOX BC-502-A
ZENITH RADIO CORPORATION
CHICAGO, ILL. U. S. A.
CONTROLLER
TYPE 5003
REF No 110 J71
A M

Oxygen Emergency Bypass Control Wheel

Oxygen Diluter Lever
• DOWN (as shown): Normal
• UP: 100 % Oxygen

Cockpit Spot Light Lamp
Rotate to adjust intensity

Detrola Radio Range Receiver
Because the SCR-522-A radio command set installed in the aircraft is of the Very High Frequency type, the BC-1206 "Detrola" radio range receiver is used for reception of signals in the Low Frequency range of 200 - 400 kHz. The Detrola is a receiver only and does not transmit. However, reception is possible using both the Detrola and the VHF command radio simultaneously.
(Not Functional)

Oxygen Regulator

COCKPIT
PULL
TO OPEN

PHONES
200 21 22 23 24 26 28 300 32 36 400
OFF

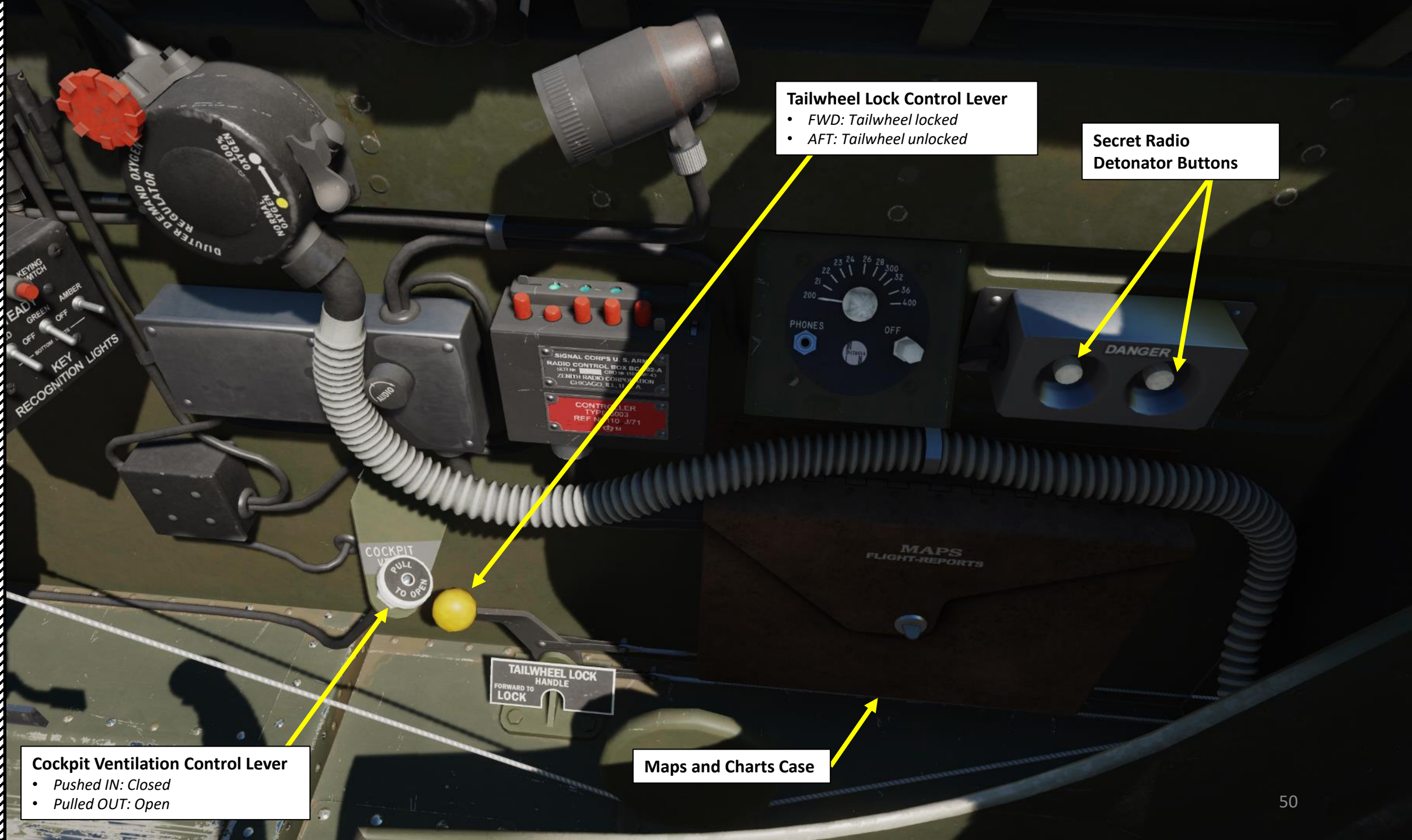

Tailwheel Lock Control Lever

- FWD: Tailwheel locked
- AFT: Tailwheel unlocked

Secret Radio Detonator Buttons

Cockpit Ventilation Control Lever

- Pushed IN: Closed
- Pulled OUT: Open

Maps and Charts Case

TAILWHEEL LOCK HANDLE
FORWARD TO LOCK

COCKPIT VENTILATION
PULL TO OPEN

PHONES OFF
200 22 23 24 26 28 300 32 36 400

DANGER

KEYING SWITCH
GREEN OFF AMBER
OFF
KEY RECOGNITION LIGHTS

100% OXYGEN
NORMA OXYGEN
DUTTER DEMAND OXYGEN
REGULATOR

SIGNAL CORPS U. S. ARMY
RADIO CONTROL BOX
TYPE 1002-A
ZENITH RADIO CORPORATION
CHICAGO, ILL. U. S. A.
CONTROLLER
TYPE 1003
REF. NO. 10 J/71
1002 M

MAPS
FLIGHT-REPORTS

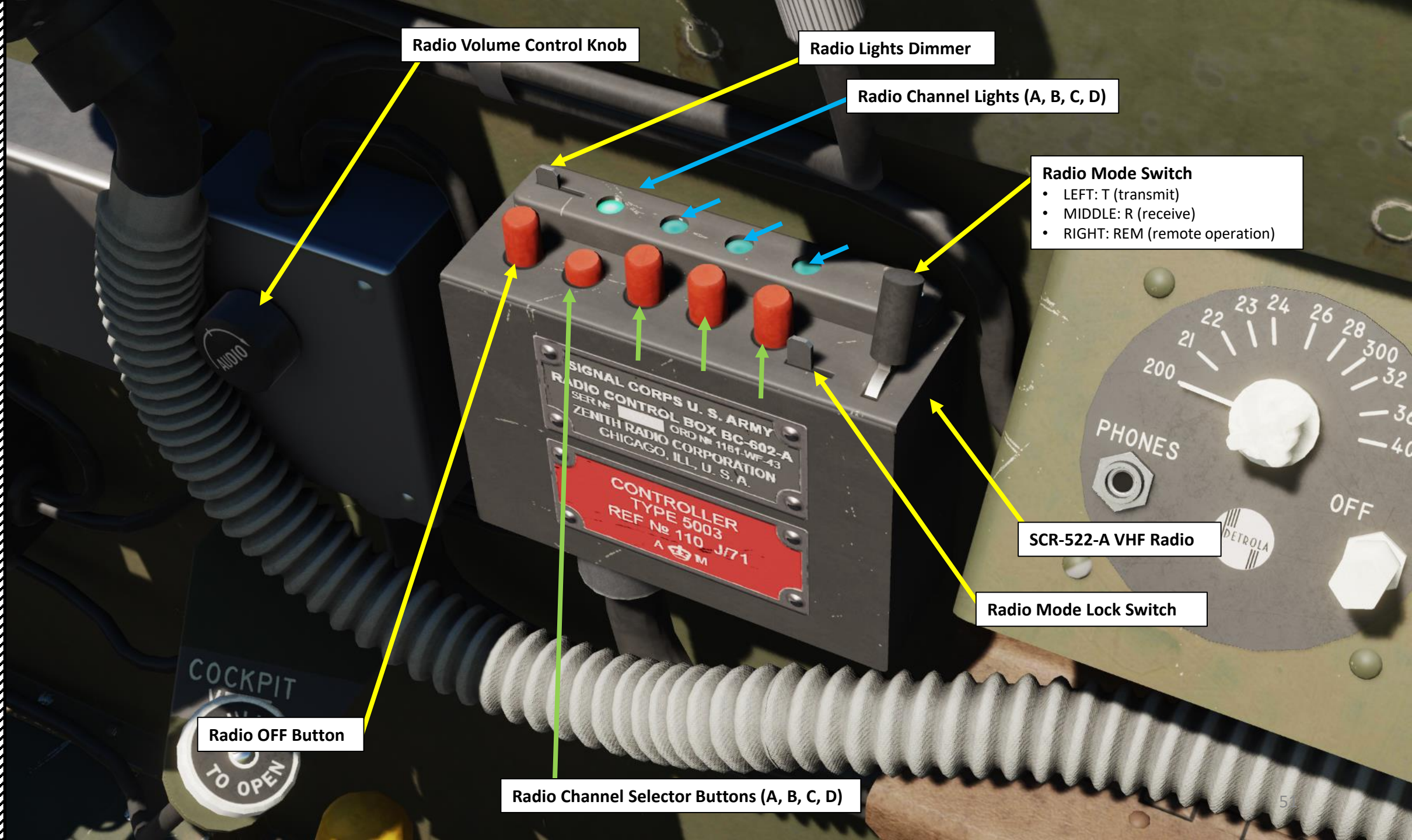

Radio Volume Control Knob

Radio Lights Dimmer

Radio Channel Lights (A, B, C, D)

Radio Mode Switch
• LEFT: T (transmit)
• MIDDLE: R (receive)
• RIGHT: REM (remote operation)

SCR-522-A VHF Radio

Radio Mode Lock Switch

Radio OFF Button

Radio Channel Selector Buttons (A, B, C, D)

SIGNAL CORPS U. S. ARMY
RADIO CONTROL BOX BC-602-A
SER. NO. [REDACTED] ORD. NO. 1181-WF-43
ZENITH RADIO CORPORATION
CHICAGO, ILL., U. S. A.
CONTROLLER
TYPE 5003
REF. No. 110-J/71
A M

COCKPIT
TO OPEN

PART 3 - COCKPIT & EQUIPMENT

P-47D
THUNDERBOLT



Rudder Control Cables





P-47D
THUNDERBOLT

PART 3 - COCKPIT & EQUIPMENT







Bubble Canopy

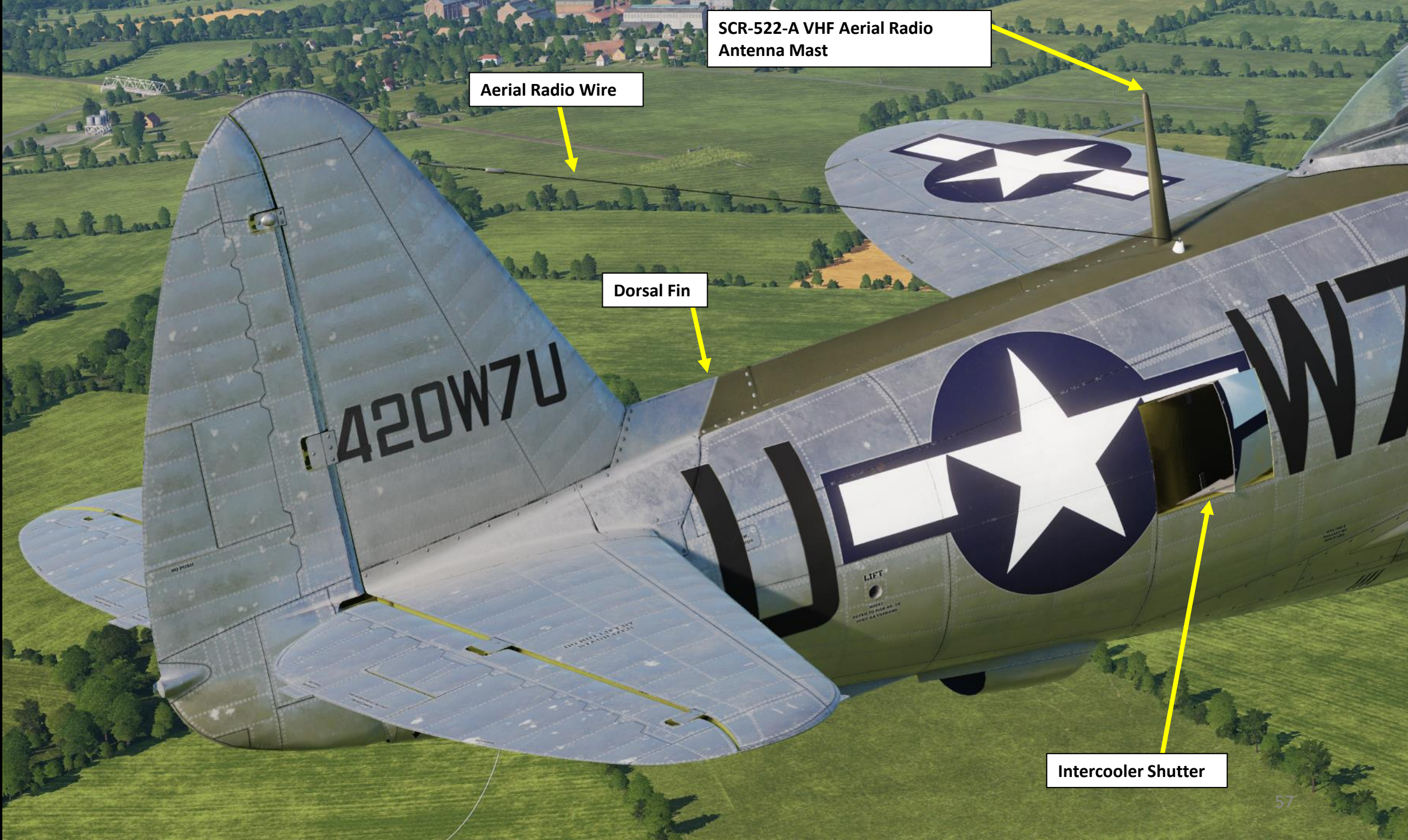

Aerial Radio Wire

SCR-522-A VHF Aerial Radio
Antenna Mast

Dorsal Fin

Intercooler Shutter

Spinner Hub

Engine Cowling Flaps

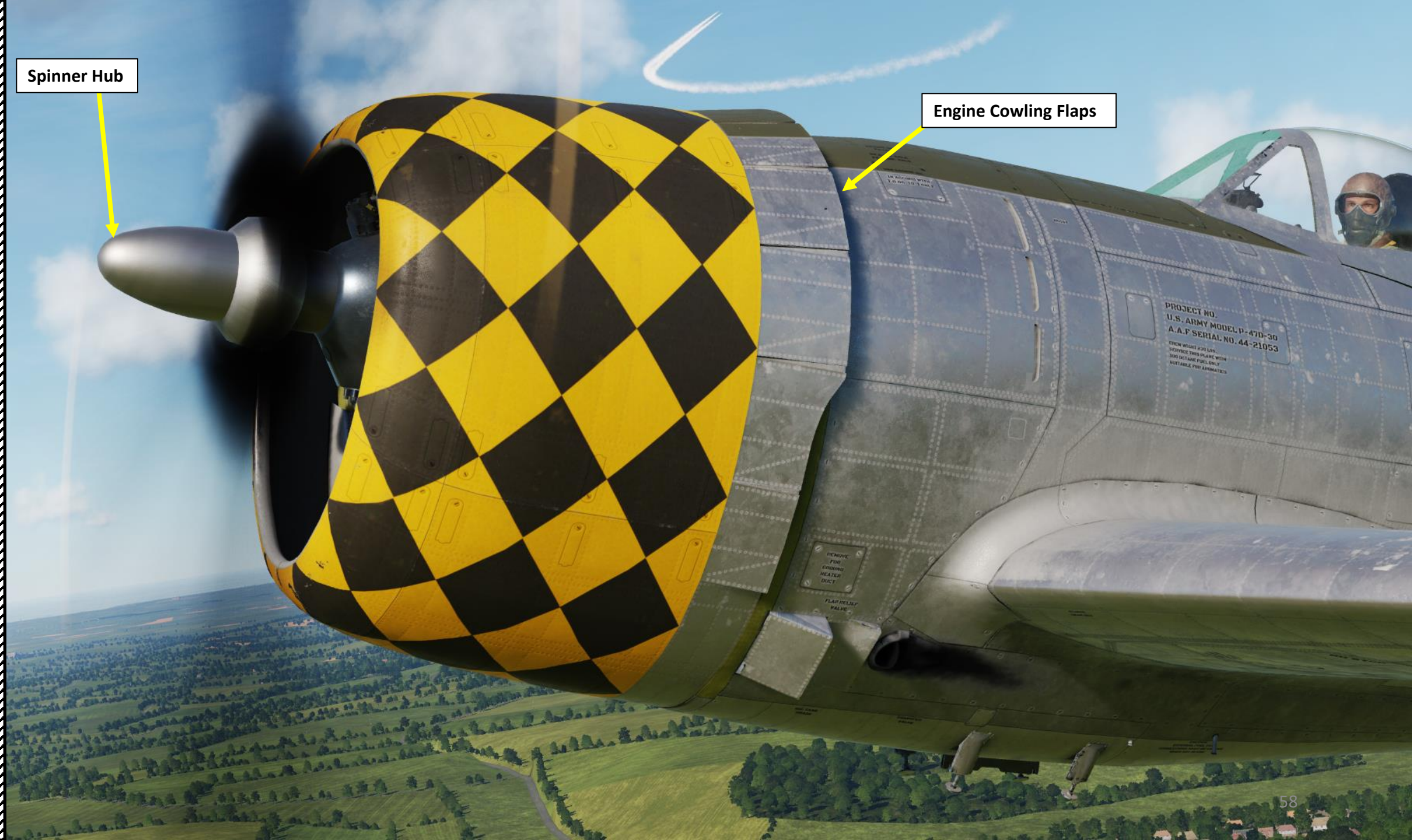

PROJECT NO.
U.S. ARMY MODEL P-47D-30
A.A.F. SERIAL NO. 44-21053

REMOVE
FOR
ENGINE
HEATER
DUCT

FLAP RELIEF
VALVE



Engine Air Duct Intake

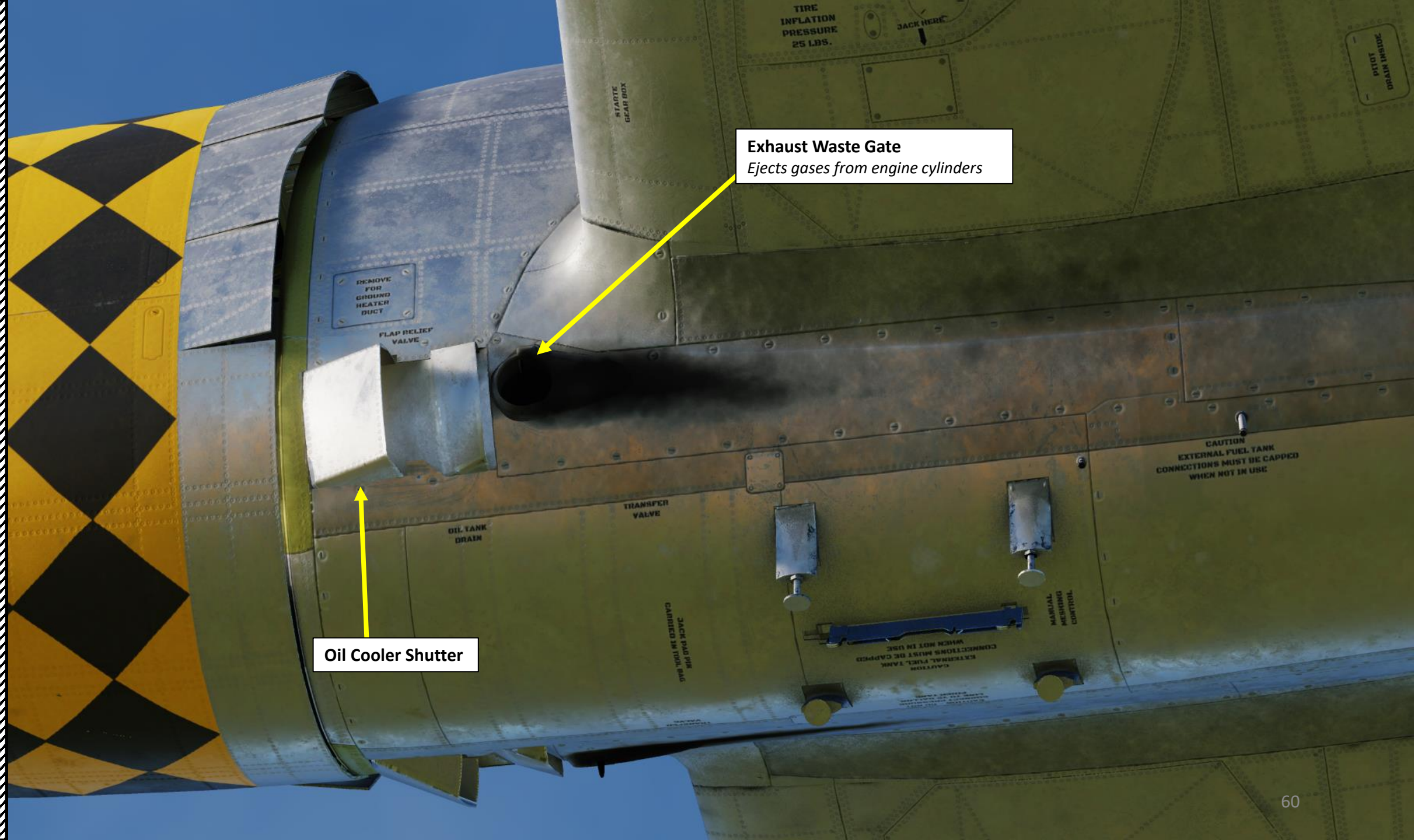

Oil Cooler Shutter

Exhaust Waste Gate
Ejects gases from engine cylinders



Belly Hardpoint

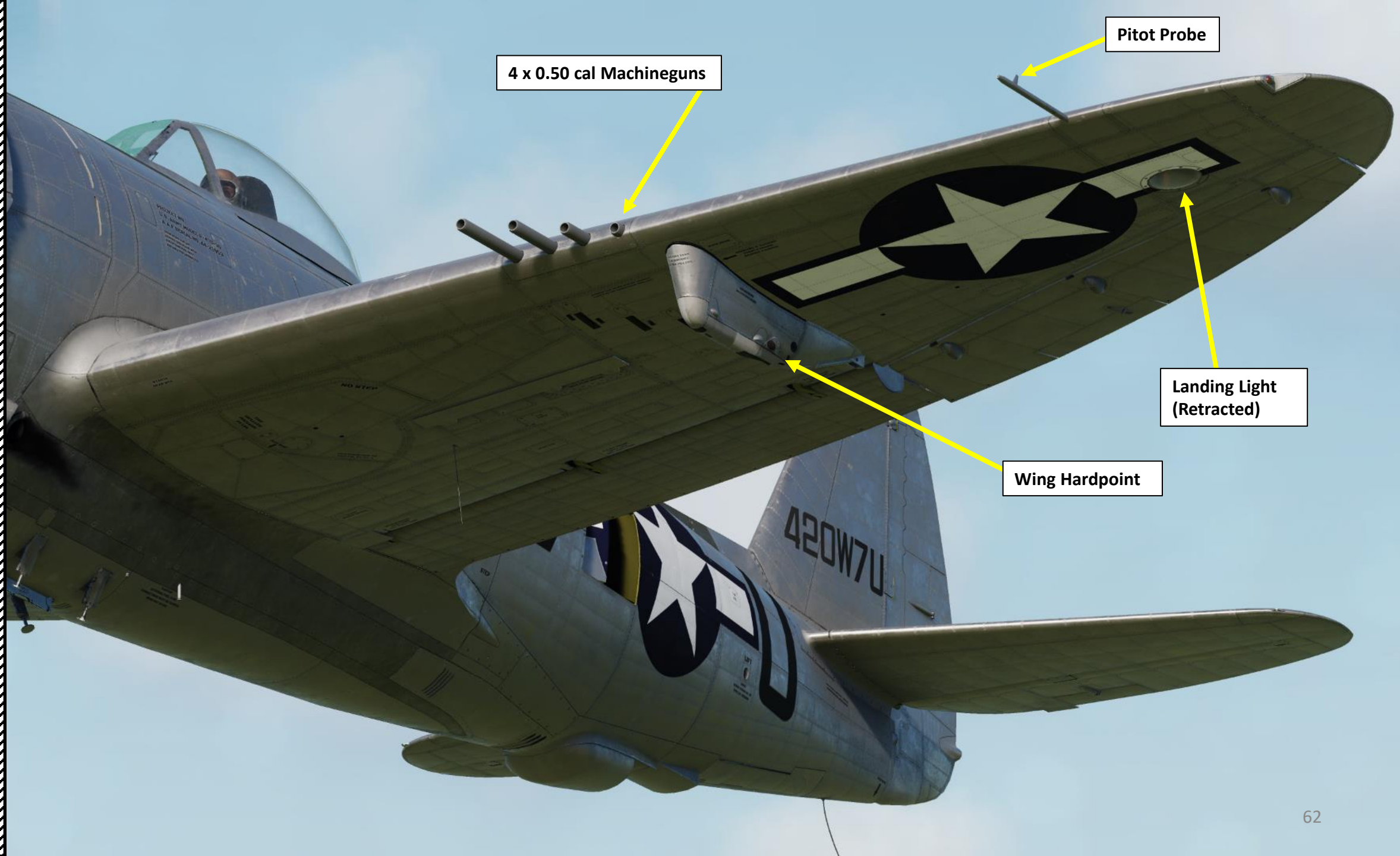

4 x 0.50 cal Machineguns

Pitot Probe

Landing Light (Retracted)

Wing Hardpoint



BATTERY LOCATION HERE

SUPER CHARGER OIL

HAND HOLD

ENTER COCKPIT FROM LEFT SIDE ONLY

03.3 IMP. GALS.
FUEL FILLER
SUITABLE FOR AROMATIC FUEL

GROUND HERE

270 U.S. GALLS
225 IMP. GALLS

FUEL FILLER
SUITABLE
FOR
AROMATIC
FUELS

HOIST

WATER
INJECTION
TAMIC
FILTER

30.0 U.S. GALLS
25.0 IMP GALLS

EXTERNAL
ELECTRICAL
POWER CART
PLUG - 24V

MANUAL MESHING CONTROL

REMOVE
FOR
GROUND
HEATER
DUCT

GRAB HANDLE ON
RIGHT WALL, WALL
TO BE KEPT CLEAR AND
WALL TO BE KEPT CLEAR



Retractable Main Landing Gear
(Hydraulically actuated)

Retractable Main Landing Gear
(Hydraulically actuated)



Static Ground Wire

Designed to control static electrical accumulations on aircraft while aircraft is stored or is undergoing servicing in a hangar.

Retractable Tailwheel
(Hydraulically actuated)

Flight Hood

Located under turbosupercharger's turbine

PART 3 – COCKPIT & EQUIPMENT

**P-47D
THUNDERBOLT**



Landing Light (Extended)





Rudder

Rudder Trim Tab

T-Bolt Empennage

Elevator Trim Tab

Elevator



Aileron

Aileron Trim Tab



P-47D
THUNDERBOLT

PART 3 – COCKPIT & EQUIPMENT



Flaps
(Hydraulically Actuated)

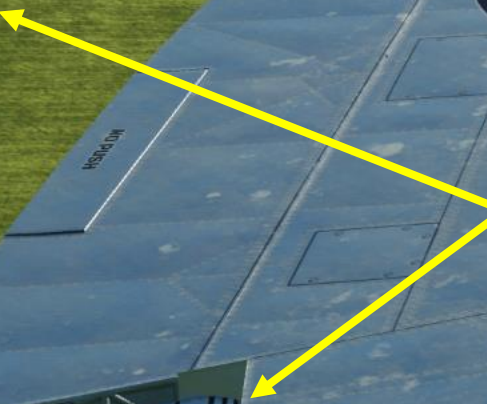

Flap Position Indicator (deg)





Compressibility Recovery Flaps





Flashlight (LALT + L)



Actual

197	GALS.
184	GALS.
161	GALS.
203	GALS.
238	GALS.
253	GALS.
272	GALS.

CONTROL OPTIONS

P-47D-30 Sim | All | Foldable view | [Reset category to default](#)

Action	Category	Keyboard
Flashlight	View Cockpit	LAlt + L

Cockpit Spot Light Lamp
Rotate to adjust intensity (blue light)



Set to START





Set to START

Cockpit (White) Light Switch



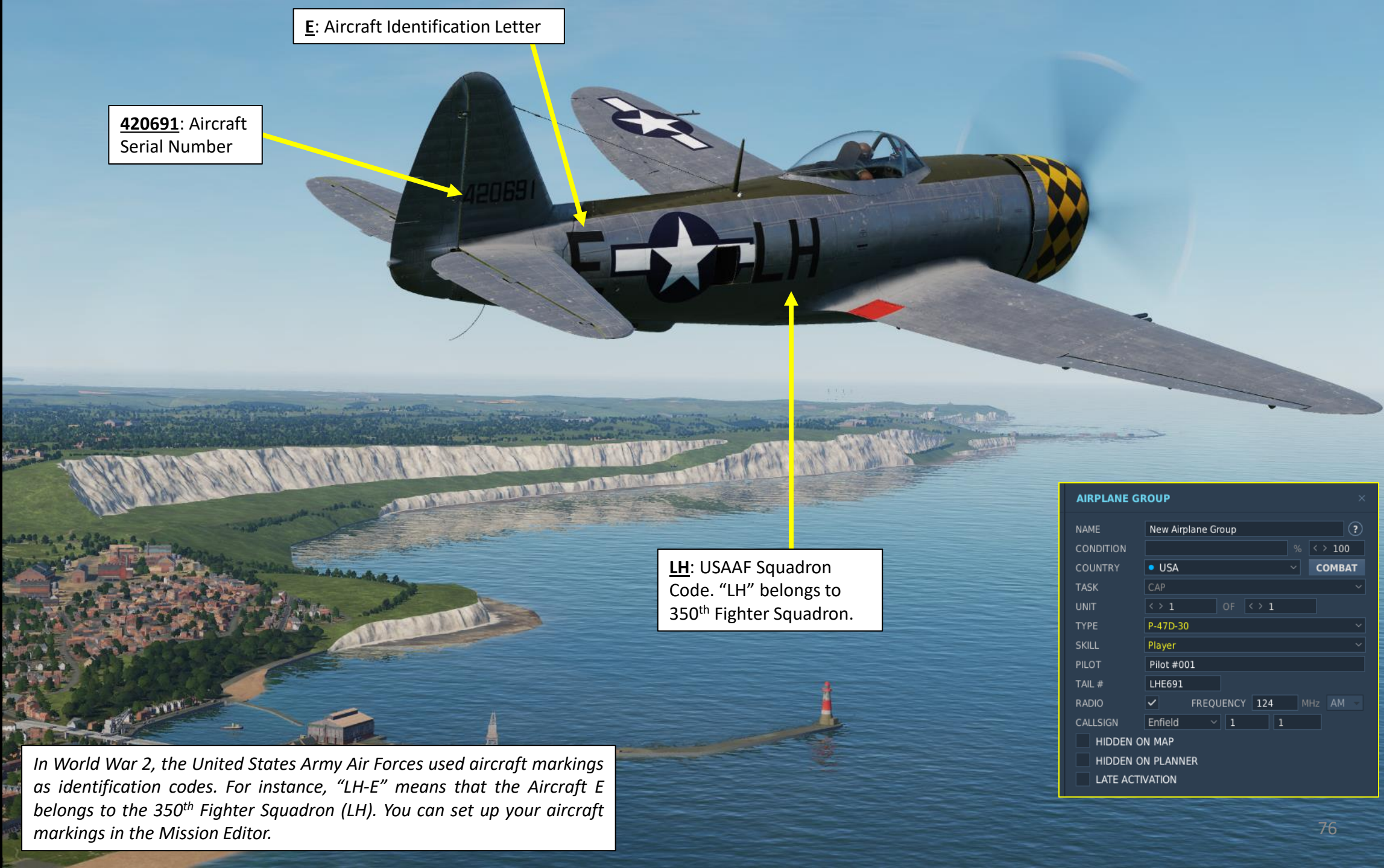

E: Aircraft Identification Letter

420691: Aircraft Serial Number

LH: USAAF Squadron Code. "LH" belongs to 350th Fighter Squadron.

AIRPLANE GROUP

NAME: New Airplane Group

CONDITION: % < > 100

COUNTRY: USA **COMBAT**

TASK: CAP

UNIT: < > 1 OF < > 1

TYPE: P-47D-30

SKILL: Player

PILOT: Pilot #001

TAIL #: LHE691

RADIO: FREQUENCY 124 MHz AM

CALLSIGN: Enfield 1 1

HIDDEN ON MAP

HIDDEN ON PLANNER

LATE ACTIVATION

In World War 2, the United States Army Air Forces used aircraft markings as identification codes. For instance, "LH-E" means that the Aircraft E belongs to the 350th Fighter Squadron (LH). You can set up your aircraft markings in the Mission Editor.



PRE-START

Within the scope of DCS, we can assume that the aircraft is in good condition. The majority of verifications/checks should pass and are therefore **optional**. These checks are preceded by (O).

1. (O) We will perform a hydraulic hand pump test first. Give the hand pump two or three pumps and verify the hydraulic pressure increases. This verifies that hydraulic pressure can be built up manually to extend the gear and flaps in case of an engine-driven hydraulic pump failure.
2. (O) Move the stick and rudder through their full range of travel to check flight controls. Confirm freedom of movement and correct response from the flight control surfaces.
3. Check and set Trim Tab controls
 - a) Set Aileron Trim to Neutral (N)
 - b) Set Rudder Trim to Takeoff (TO)
 - c) Set Elevator Trim:
 - If auxiliary fuel tank is empty, set elevator trim to Neutral (N).
 - If fuel is present in the auxiliary fuel tank, the center of gravity of the aircraft is shifted aft, which requires Nose Heavy (NH) trim. Set elevator trim to approximately 0.75 inch NH (Nose Heavy) forward of Neutral (N).
4. Engage Parking Brake
 - a) Pull and hold the parking brake handle
 - b) Depress and release toe brake pedals
 - c) As you raise your feet from the toe brake pedals, the pedals should remain depressed in the “braking” position.
 - d) Release the parking brake handle. It should remain in the ENGAGED position.

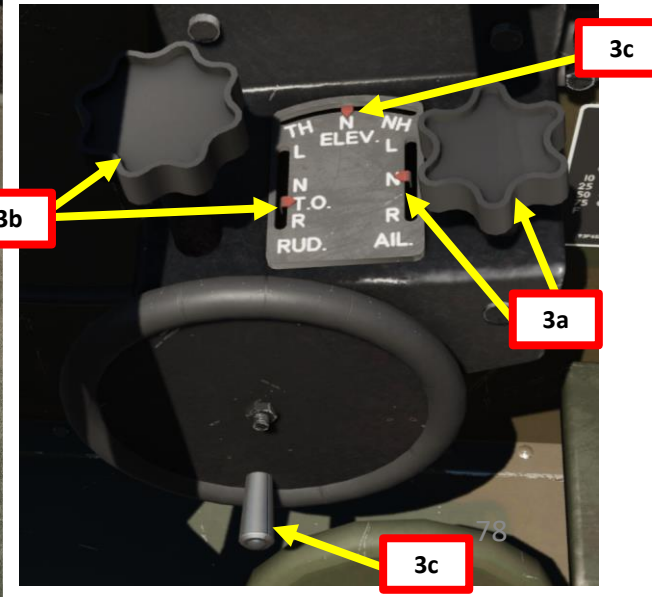
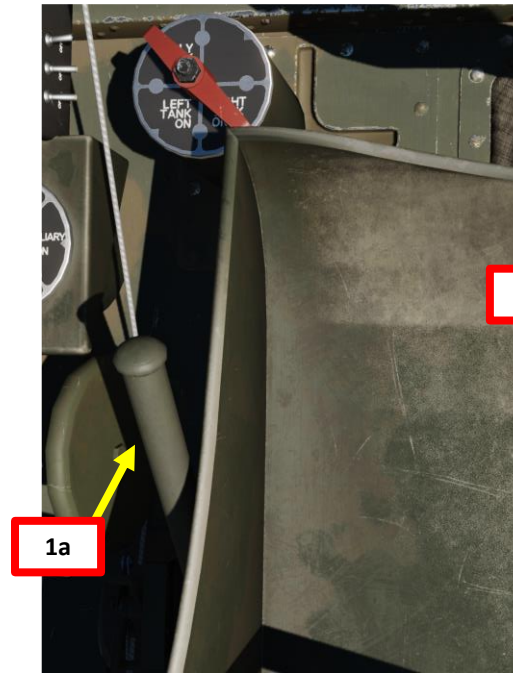
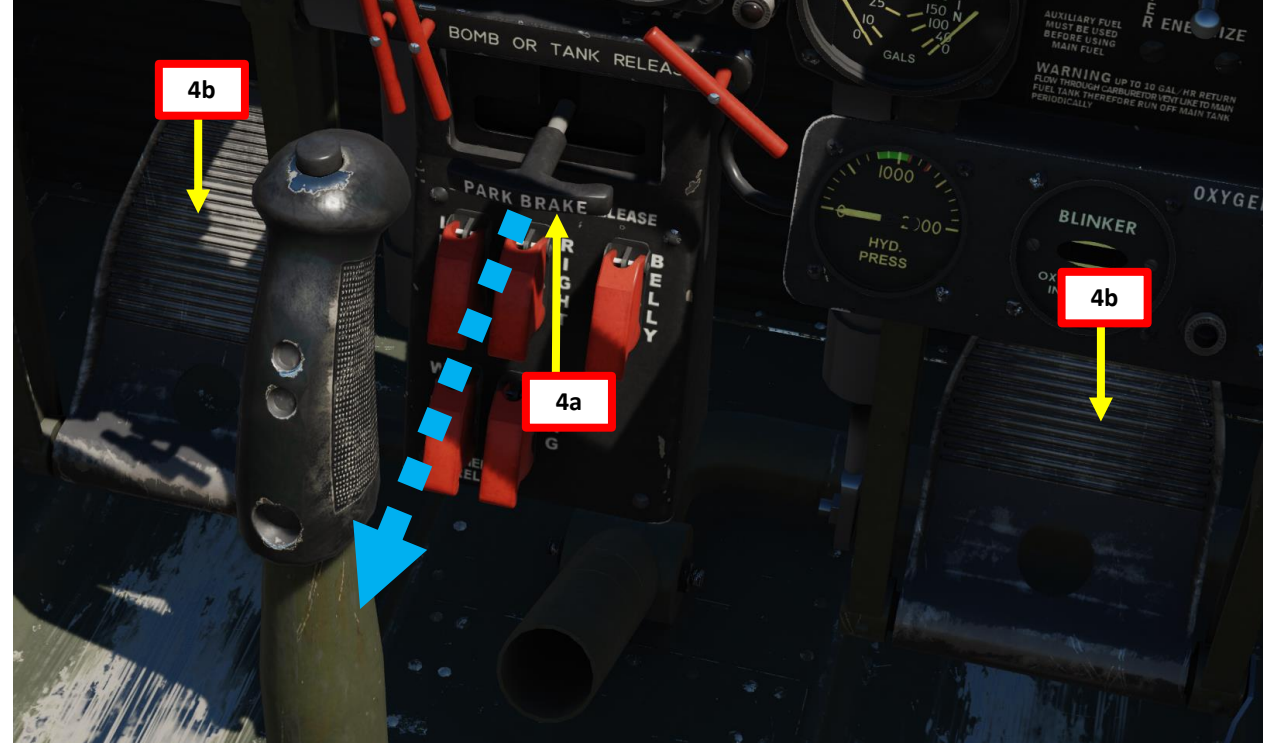

PRE-START

- Set Altimeter to the airport's elevation by rotating the barometric pressure setting knob.



ENGINE START PROCEDURE

6. Set Air Filter Control Lever FWD (ON) if aircraft is operating in dusty conditions. Otherwise, leave Air Filter Control Lever AFT (OFF).
7. Set Carburetor Air Heat Control Lever – FWD (COLD).
8. Rotate Fuel Boost Pump Rheostat counter-clockwise to START/ALTITUDE position.
9. Set Fuel Selector Valve Handle to MAIN (short shoulder FWD).
10. Set Generator Switch – UP (ON). This will provide electrical power once engine is up and running.
11. Set Propeller Governor Switch – UP (Automatic Constant Speed). This ensures the propeller RPM is controlled through the propeller (P) lever on the throttle quadrant.

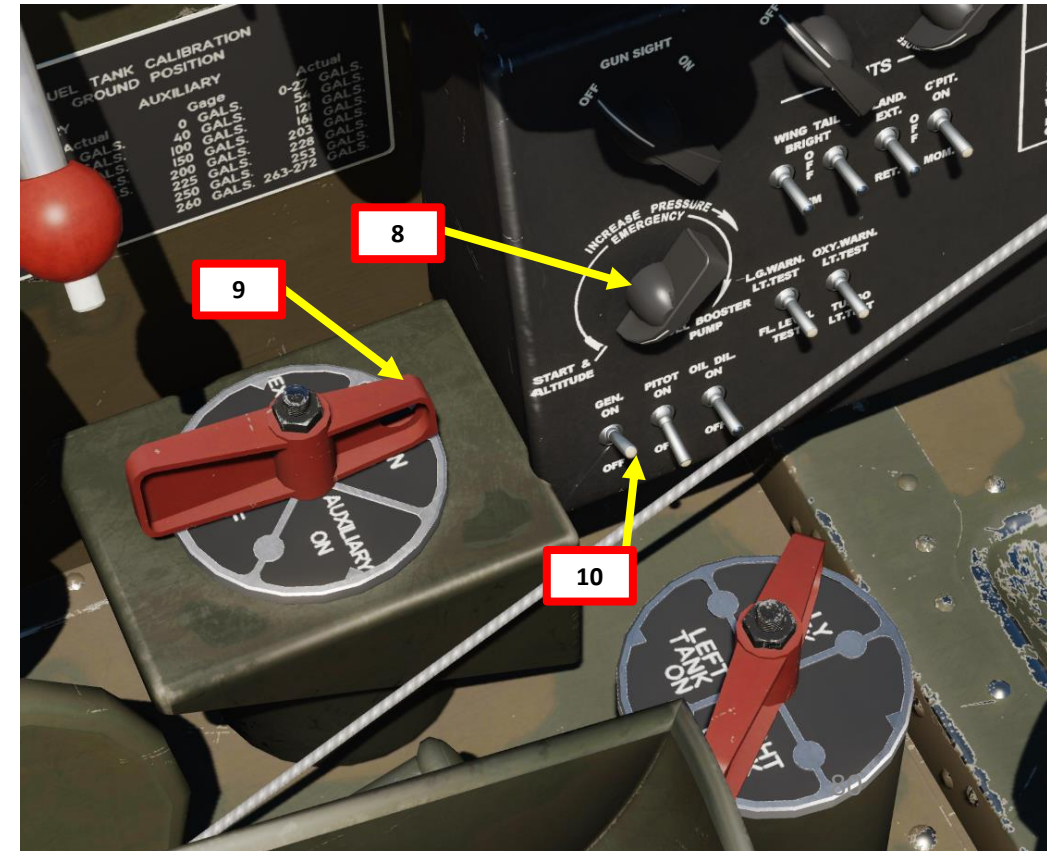
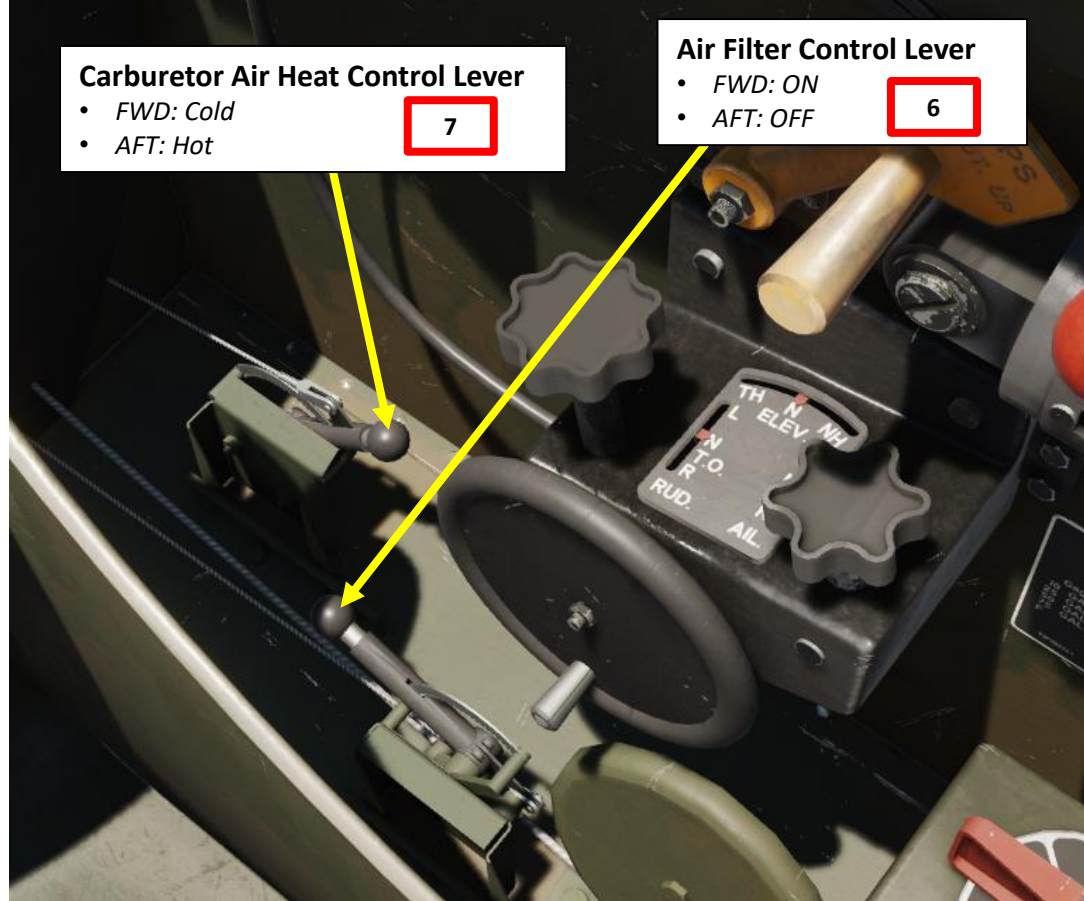

ENGINE START PROCEDURE

12. Open engine cowl flaps. When the engine is not running, the only way to open them is to generate hydraulic pressure with the hand pump.
 - a) Set Flaps Lever to NEUTRAL (Middle) so that the flaps do not soak up all the hydraulic pressure.
 - b) Pull the Hydraulic Hand Pump 5 to 10 times to build up sufficient hydraulic pressure.
 - c) Pull the Engine Cowl Flaps Handle until the cowl flaps open fully.
 - d) Set Flaps Lever to UP (FWD).

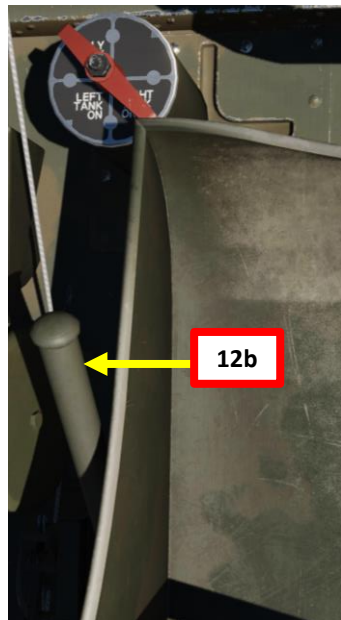

ENGINE START PROCEDURE

13. Set Battery Switch – ON (LEFT)
14. Verify that no circuit breakers pop out on the electrical panel and the propeller governor panel.
15. Use Intercooler Shutters Control (INTRCLR) Switch to set the intercooler shutters to the NEUTRAL position.
16. Use Oil Cooler Shutters Control (OIL CLR) Switch to set the oil cooler shutters to the NEUTRAL position.
 - Note: If operating in cold weather, oil cooler shutters should be set to CLOSED position instead.
17. Move throttle one inch forward.
18. Set Turbosupercharger (B) lever to OFF position (AFT).
19. Set Mixture Control (M) lever to IDLE CUT-OFF (AFT).
20. Set Propeller RPM Control (P) lever to INCREASE RPM (FULL FWD)

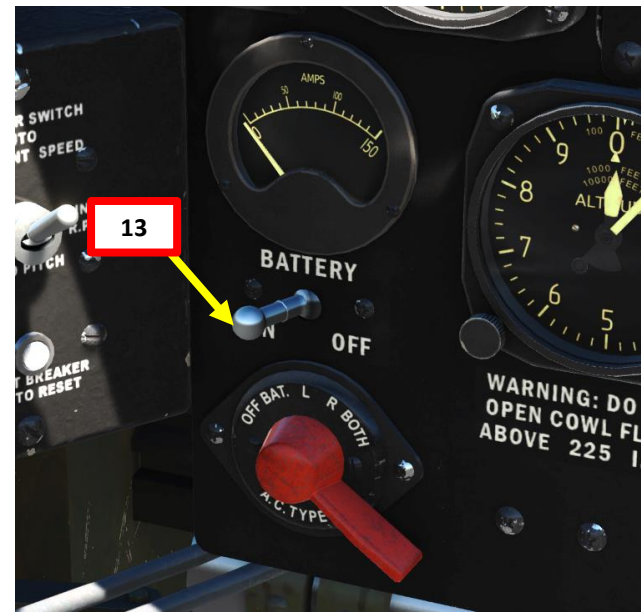
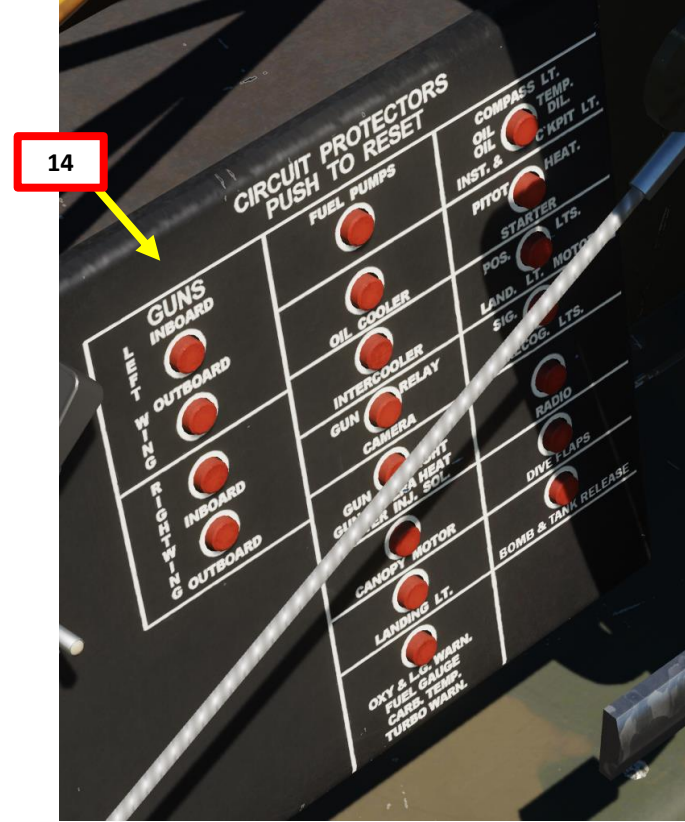
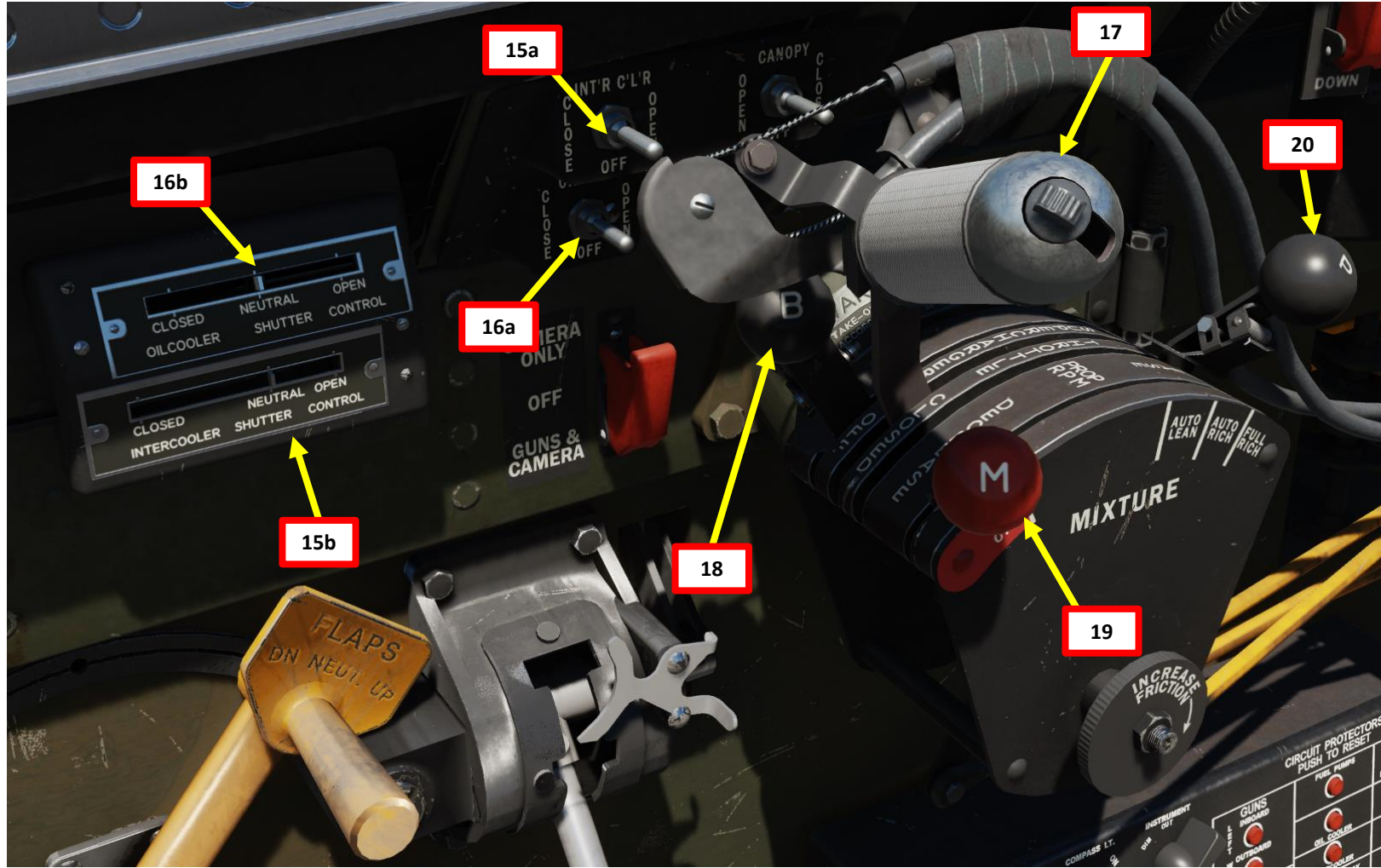

ENGINE START PROCEDURE

21. The crew chief will have already rotated the propeller several turns by hand.
22. Prime the engine
 - a) Unlock primer handle by turning it counterclockwise (right click).
 - b) Prime engine four to six times in order to pump fuel into combustion chamber. This is performed by pulling the primer handle and pushing it back in (hold left click to pull, release click to push).
 - 2 to 4 strokes are required for hot weather
 - 4 to 6 strokes are required for cold weather
 - c) Lock primer handle back in locked position (right click).

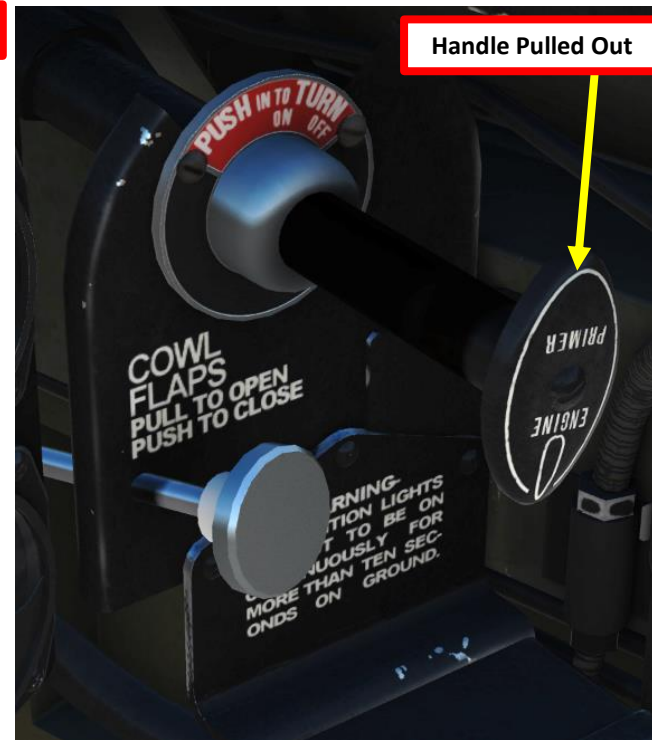

ENGINE START PROCEDURE

23. Verify that the propeller is clear and command « Clear prop! » to warn people around you that you are about to start the engine.
24. Set Magneto (Ignition) Selector Switch to BOTH to select both magnetos.
25. Flick the starter switch up to ENGAGE, then back to OFF. This seats the starter brushes on the commutator.
26. Set STARTER switch to ENERGIZE (DOWN) position for 15 seconds by left clicking and holding the switch DOWN. This will energize (crank up) the starter's inertial flywheel.
27. After 15 seconds, set STARTER switch to ENGAGE (UP) and keep it held up by right clicking and holding the switch UP. This transfers the flywheel's energy to the engine to turn it over.
28. Keep the STARTER switch to ENGAGE (UP) until the engine fires.
29. Once engine fires (you will hear a distinct « cough »), set Mixture Control (M) lever to AUTO RICH position (FWD). The STARTER switch can be left in ENGAGE for five or six revolutions of the propeller to provide a hotter spark and help the engine to « catch ».
 - *Note: I suggest mapping the « Mixture AUTO RICH» binding to a switch on your throttle to let your right hand hold the starter switch with the mouse while the left hand moves the mixture lever.*
30. Return STARTER switch to OFF when the engine is running on its own. The engine-driven hydraulic pump will start running and raise the flaps.
31. If the engine does not catch on the first attempt, release the STARTER switch and return the mixture lever to IDLE CUTOFF (AFT). Something like engine priming, fuel supply or electrical power could have been missed along the way. You will want to wait one minute to allow the starter to cool down and double check the cockpit setup before trying again.

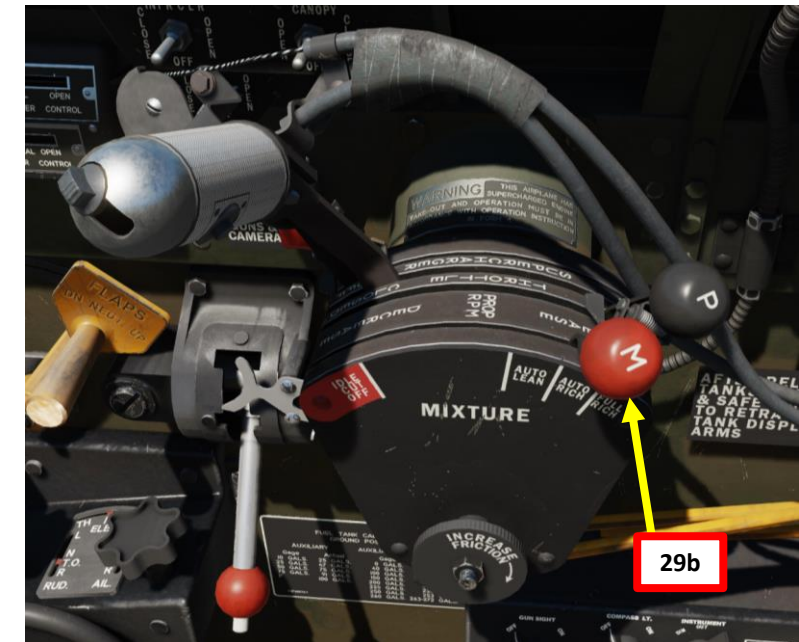
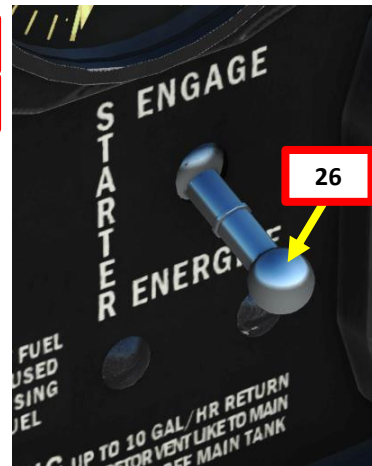
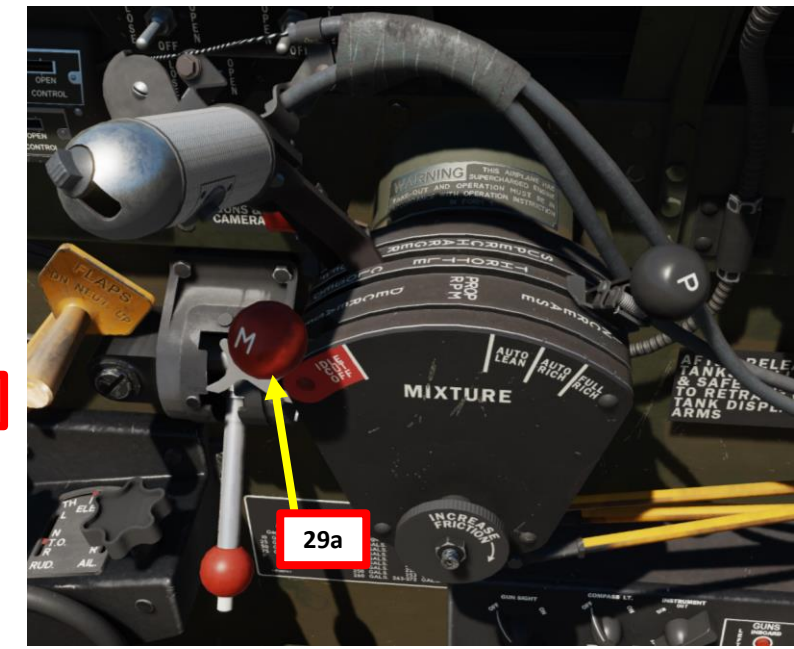

ENGINE START PROCEDURE



ENGINE WARM UP

32. Adjust throttle so the engine RPM is about 900 and wait for the engine to warm up (this process can take about 3 minutes)
 - a) Verify that oil pressure increases. If oil pressure is not above 25 psi within 30 seconds, shut down the engine.
 - b) In cold weather, you can expect an oil pressure increase to 150-200 psi before it settles down to its normal range of 75-85 psi.
 - c) Oil temperature gauge should settle down at about 50 deg C.
 - d) Fuel pressure should be 22-24 psi.
 - e) Cylinder Head Temperature (CHT) should settle in at about 100-260 deg C.
 - f) Check for proper Hydraulic Pressure (should be between 800 and 1100 psi).
 - g) Vacuum Suction gauge's pointer should be within the values of 3,85 – 4,15 in Hg
33. Once oil pressure, oil temperature, fuel pressure, cylinder head temperature and fuel pressure are stabilized at the normal operating values listed above, increase throttle above 1000 RPM.

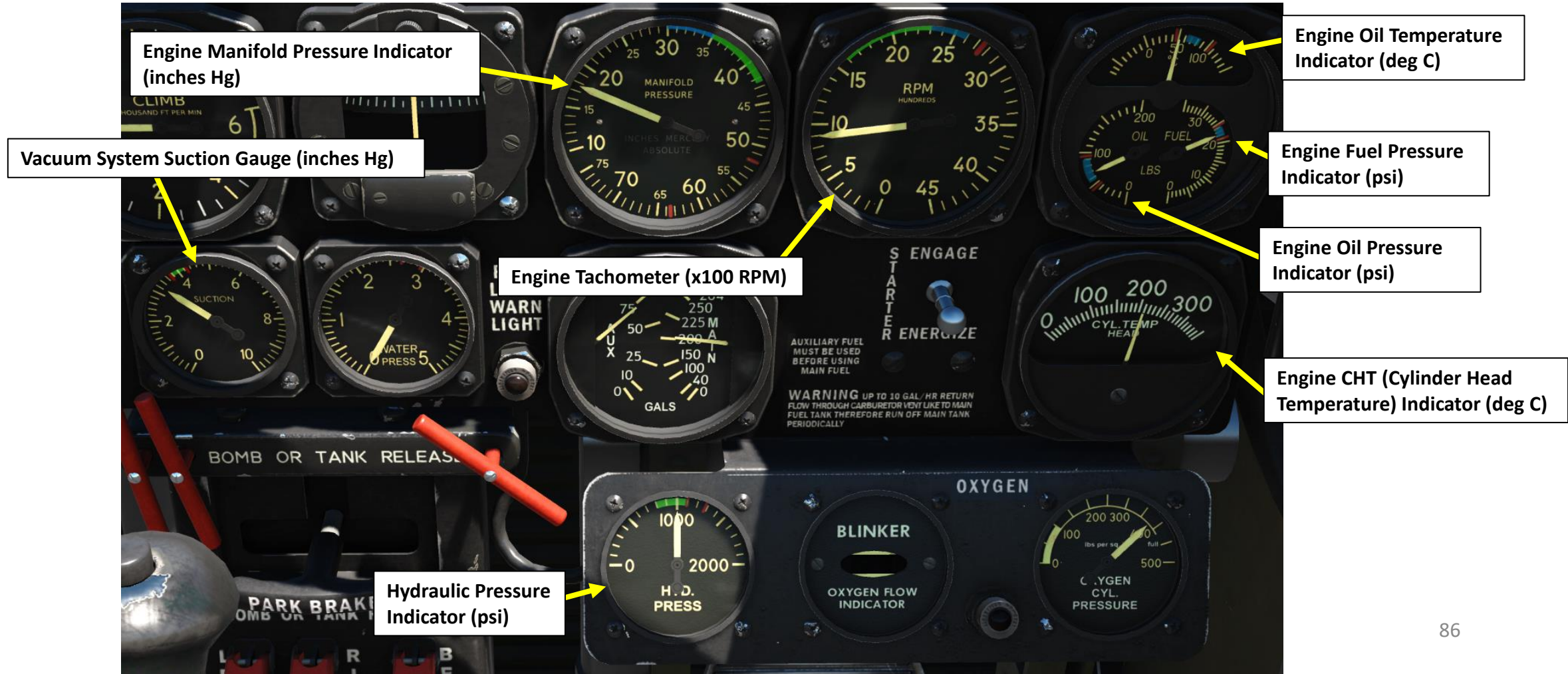

POST-START

34. Uncage and set the Horizon Gyro
 - a) Left click on the Caging knob to uncage the gyro
 - b) Scroll mousewheel to rotate the Horizon Alignment Knob to align the horizon line slightly below the wings. Since we are sitting nose high on the ground.
35. Check that directional gyro has had enough time to calibrate by comparing its heading with the magnetic compass' heading.
36. Turn on radio (this is typically delayed as long as possible to preserve the battery but can be done at any time if communications are required earlier in the mission)
 - a) Select Channel A, B, C or D (as per mission briefing).
 - "A" channel is usually used for all normal plane-to-plane communications with a Controller.
 - "B" channel is common to all VHF-equipped control towers. It is normally use to contact the control tower for takeoff and landing instructions.
 - "C" channel is frequently use in contacting homing stations.
 - "D" channel is normally used for plane-to-ground contact with Radio Direction Finding (D/F) stations.
 - b) Rotate AUDIO knob to adjust volume as desired.
 - c) Set Radio Mode switch RIGHT to REM (Remote Operation)

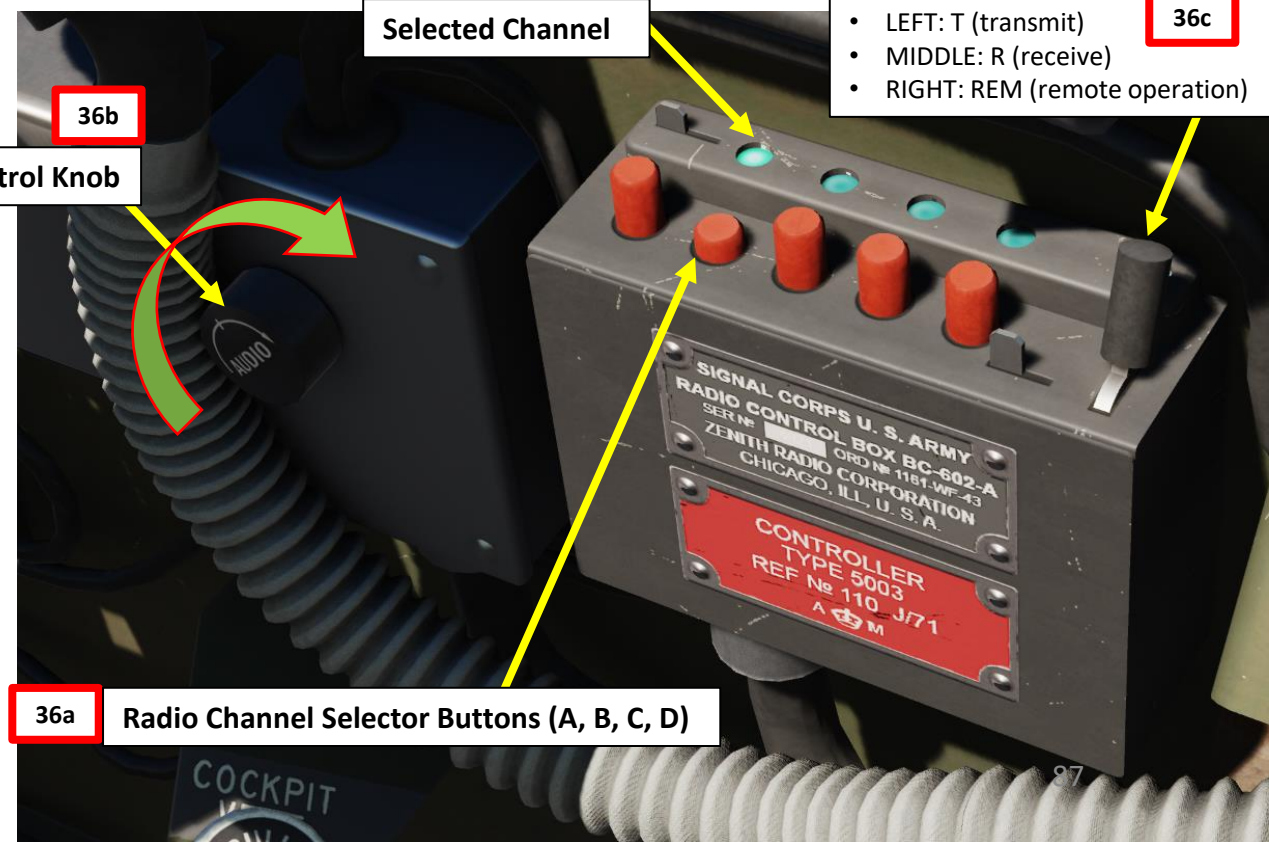
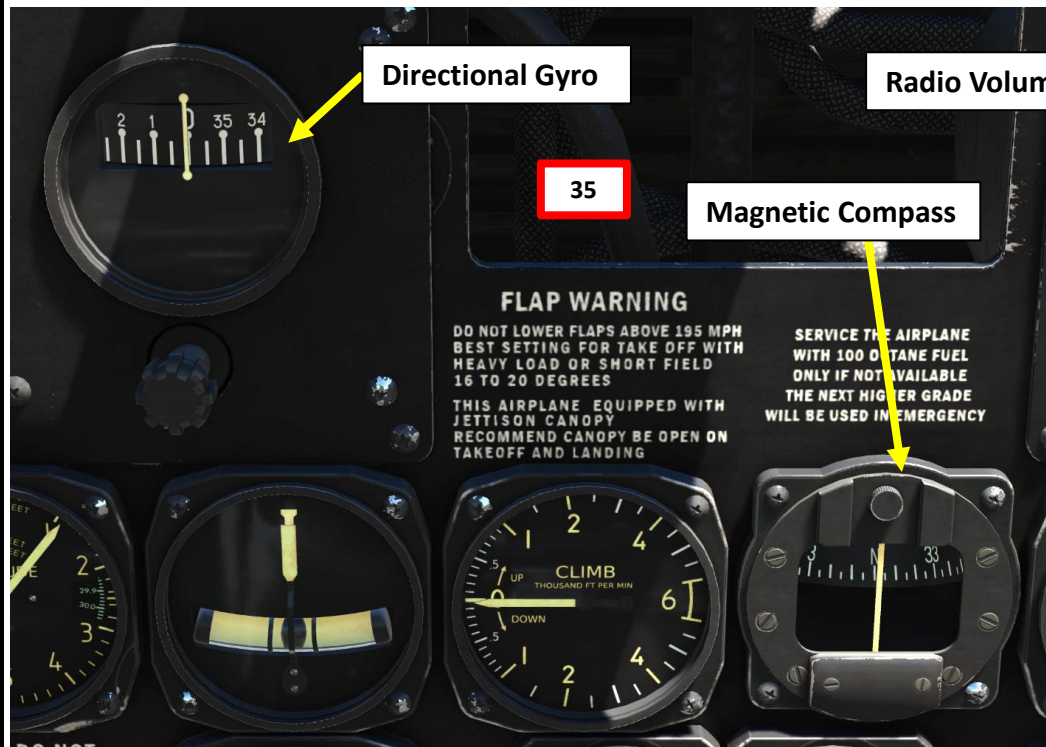
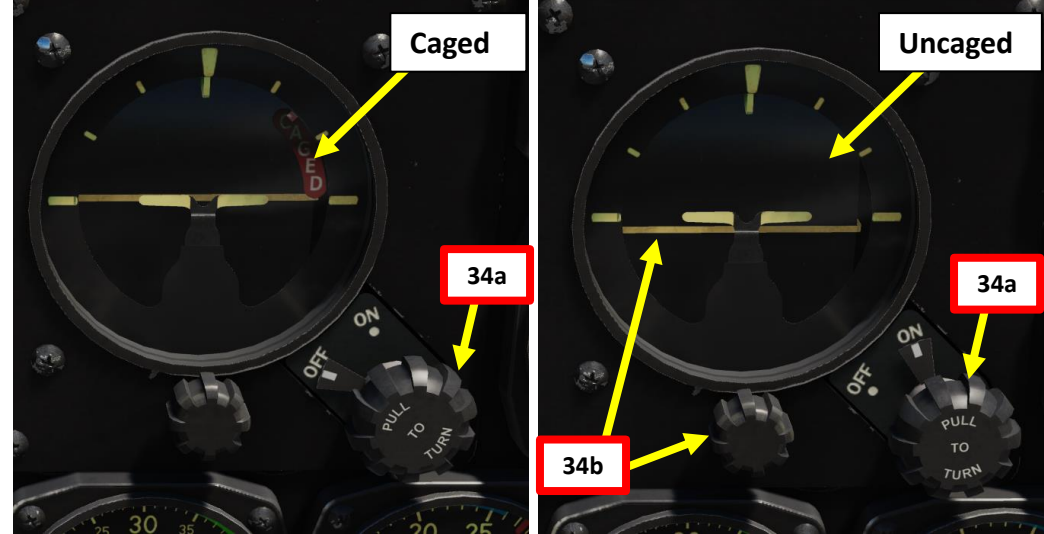

POST-START

Within the scope of DCS, we can assume that most of warning light checks will pass and are therefore **optional**. These checks are preceded by **(O)**.

- 37. **(O)** Set LG WARN LT TEST / FL LEVEL TEST switch UP to test the Landing Gear Warning Light. Confirm that the **Red LDG WARNING LIGHT** illuminates when switch is held UP.
- 38. **(O)** Set LG WARN LT TEST / FL LEVEL TEST switch DOWN to test the Fuel Level Light. Confirm that the **FUEL LEVEL WARN LIGHT** illuminates when switch is held DOWN.
- 39. **(O)** Set OXY WARN LT TEST / TURBO LT TEST switch DOWN to test the Turbosupercharger Light. Confirm that the **TURBINE OVERSPEED LIGHT** illuminates when switch is held DOWN.
- 40. **(O)** Set OXY WARN LT TEST / TURBO LT TEST switch UP to test the Oxygen Warning Light. Confirm that the **LOW OXYGEN PRESSURE** warning light illuminates when switch is held UP.

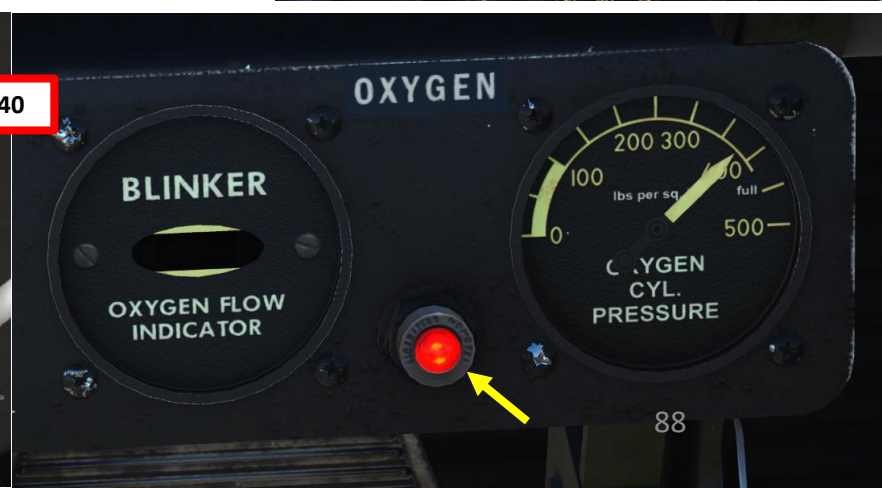
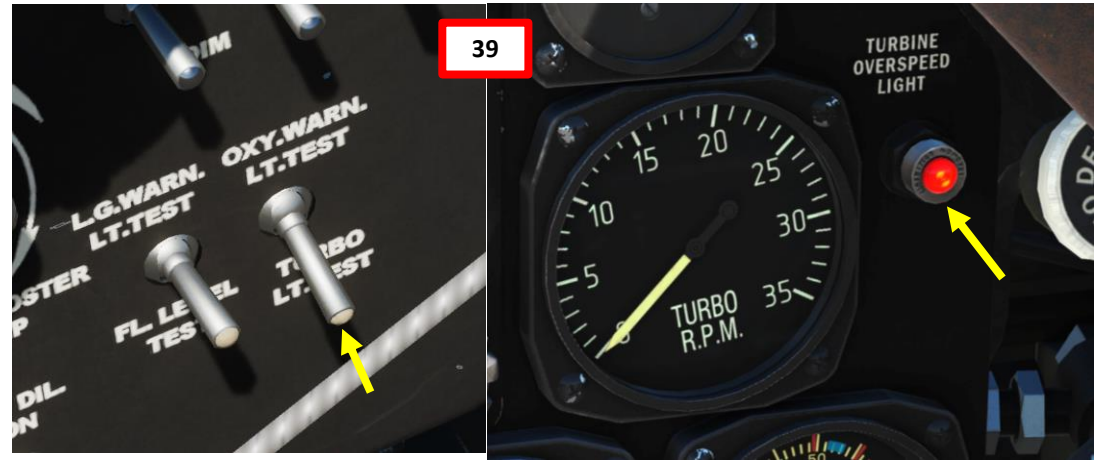
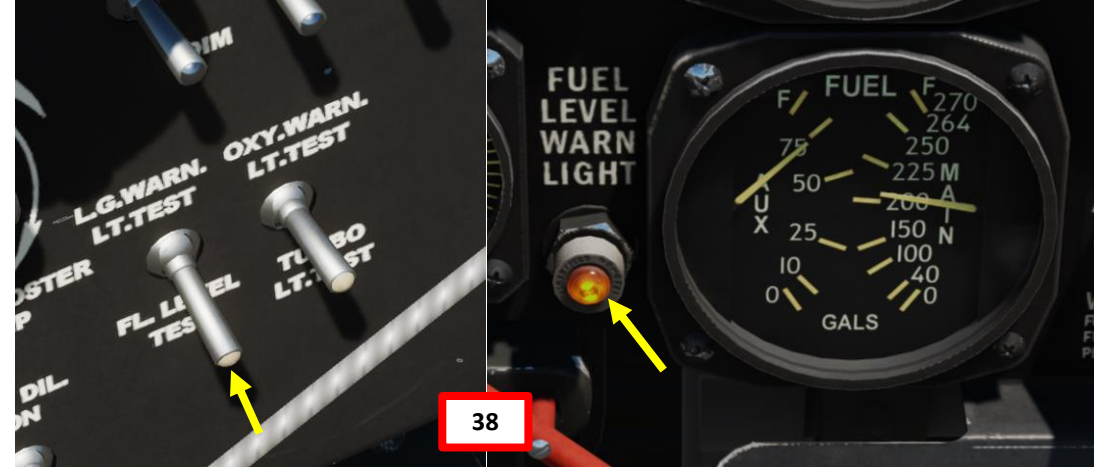

ENGINE RUN-UP

The engine run-up is basically a series of checks to make sure that every engine component is behaving as expected in relevant engine regimes. *Within the scope of DCS, we can assume that most of engine run-up checks will pass and are therefore optional. These checks are preceded by (O).*

- 41. (O) When engine is warmed up, advance throttle to set 30 in Hg of manifold pressure and adjust Propeller RPM Control (P) lever to 2000 RPM.

Magneto Check

- 42. (O) Make sure engine RPM is at 2000 RPM, then set Magneto (Ignition) switch to R for the right magneto, then L for the left magneto while watching the engine RPM gauge. You should expect a drop of about 60 RPM while running on either magneto, but never more than 100 RPM.
- 43. (O) If all is well, set Magneto (Ignition) switch back to BOTH.

Propeller Governor Operation Check

- 44. (O) Pull the Propeller RPM Control (P) lever back until you get a drop of about 200 RPM on the gauge (1800 RPM).
- 45. (O) Leave the Propeller RPM Control lever in place for a moment to ensure there is no oscillation that could indicate a faulty governor.
- 46. (O) Return RPM to 2000 using the Propeller RPM Control lever.

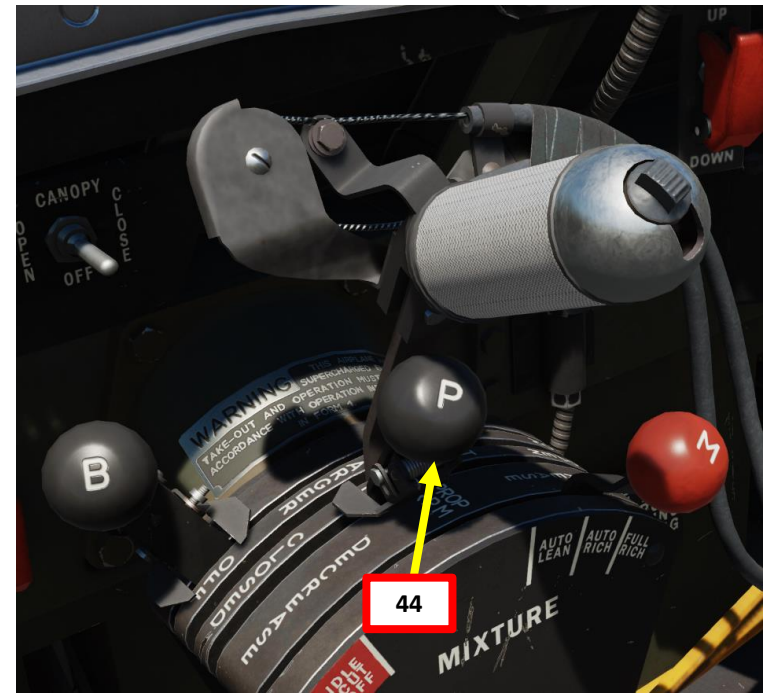

ENGINE RUN-UP

Propeller Backup Operation Check

- 47. (O) Set Propeller Governor Switch to FIXED PITCH (DOWN) position.
- 48. (O) Toggle Propeller Governor Switch FWD to INCREASE and confirm that RPM increases.
- 49. (O) Toggle Propeller Governor Switch AFT to DECREASE and confirm that RPM decreases.
- 50. (O) Set Propeller Governor Switch to CONSTANT SPEED AUTO (UP) and confirm that RPM goes back to governed propeller speed 2000 RPM.



ENGINE RUN-UP

Fuel Tank Feed Check

- 51. (O) While on ground, the fuel tanks quantity readings are inaccurate from the gauge and must be translated through the Fuel Tank Calibration Ground Position Table.
- 52. (O) If fuel is available in auxiliary tank, set Engine Fuel Selector Valve Handle from MAIN to AUXILIARY. Verify that engine does not stutter or hesitate for more than a second or two and fuel pressure remains between 22 and 24 psi.
- 53. (O) If fuel is available in external tanks, perform similar checks with the Fuel Selector Valve Handle being set to EXTERNAL and with the External Fuel Tank Selector Valve Handle being set to the installed tanks.
- 54. (O) When fuel checks are performed, set Engine Fuel Selector Valve Handle back to MAIN.

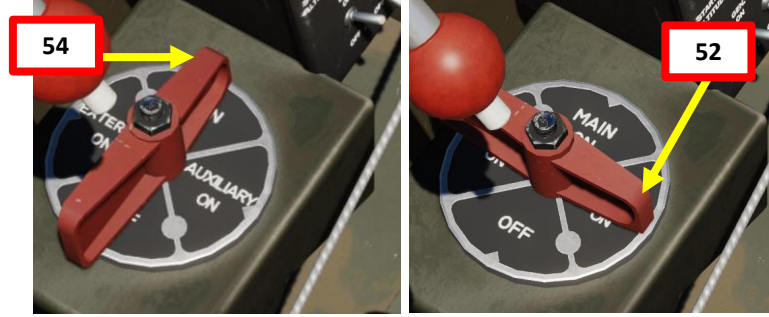

Generator Check

- 55. (O) Check for a charge on the Ammeter. This indicates the generator is operating.
 - If no charge is indicated, verify the RPM is set above 1100 or so required to operate the generator. If there is still no charge indicated, there is a problem and you should short the aircraft.
 - If the charge is low, it means the battery is fully charged and helping pick up the electrical load.



Engine Instrument Check

- 56. Check engine instruments readings at 2000 RPM.
 - a) Oil Pressure: 75-85 psi
 - b) Oil temperature: approx. 50 deg C
 - c) Fuel pressure: 22-24 psi
 - d) Cylinder Head Temperature (CHT): 100-260 deg C
 - e) Hydraulic Pressure: 800 and 1100 psi

Important Note about Battery Power

- 57. Engine RPM on the ground and during taxi will usually be below the 1100 RPM required to run the generator, so you will be using up the battery power below this RPM. You will want to minimize the time on the ground or run the engine up periodically to run the generator and refresh the charge. Keep an eye on your ammeter!



Fuel Tank Calibration Ground Position Table

AUXILIARY		MAIN	
Gage	Actual	Gage	Actual
10 GALS.	25 GALS.	0 GALS.	0-27 GALS.
25 GALS.	47 GALS.	40 GALS.	54 GALS.
50 GALS.	75 GALS.	100 GALS.	121 GALS.
75 GALS.	91 GALS.	150 GALS.	161 GALS.
F	100 GALS.	200 GALS.	203 GALS.
		225 GALS.	228 GALS.
		250 GALS.	253 GALS.
		260 GALS.	263-272 GALS.



TAXI PROCEDURE

1. Unlock tailwheel by setting the Tailwheel Lock Control Lever AFT.
2. Tap toe brakes to release the parking brake
3. Throttle up to gain forward motion. Taxiing should be done at 10-15 mph maximum (recommended RPM is 900).
4. The nose restricts forward visibility. This means that in taxiing, you must zig-zag (or "S-turn") continually.
5. To perform a turn, use differential braking by gently tapping the wheel brake pedal on the side you wish to turn.

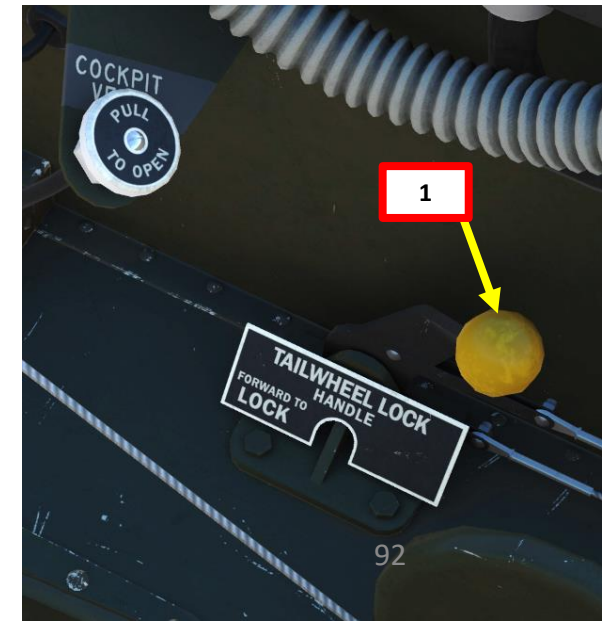
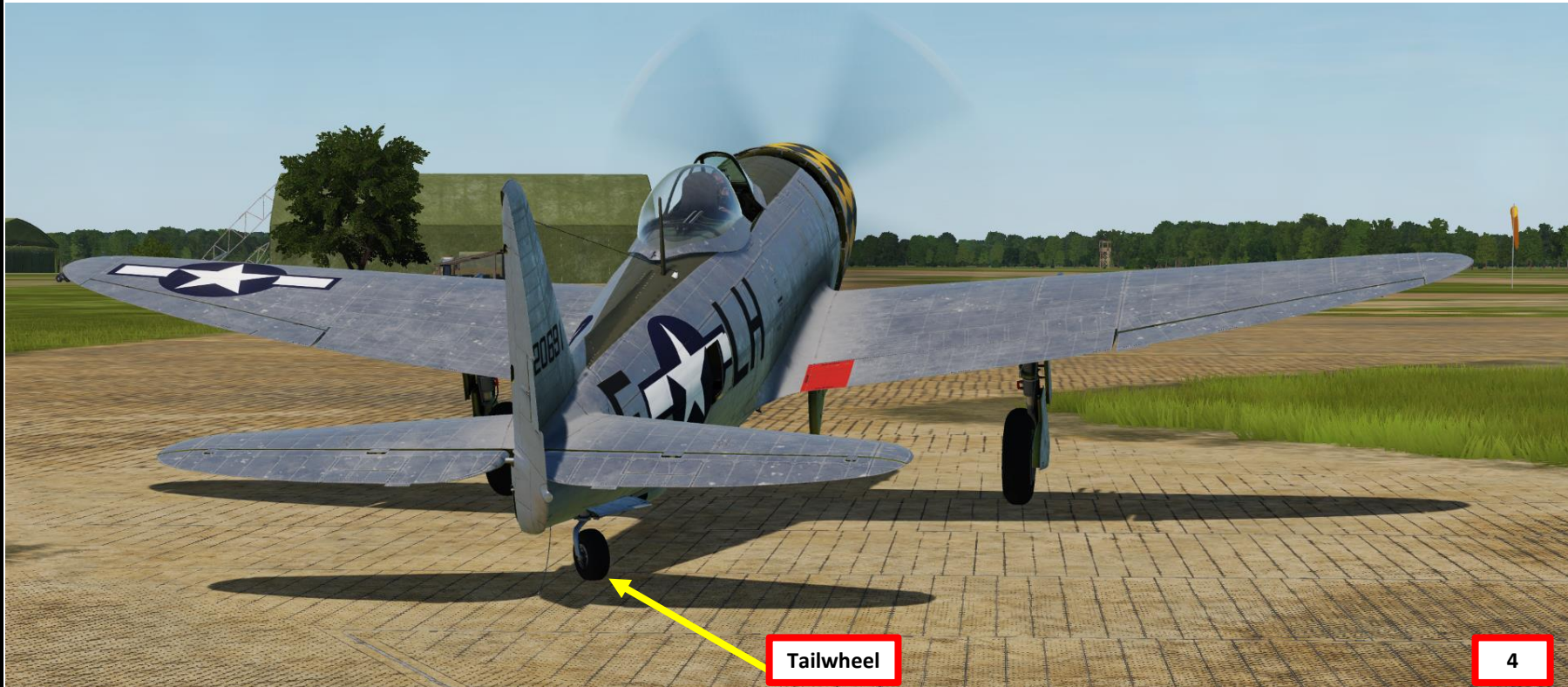
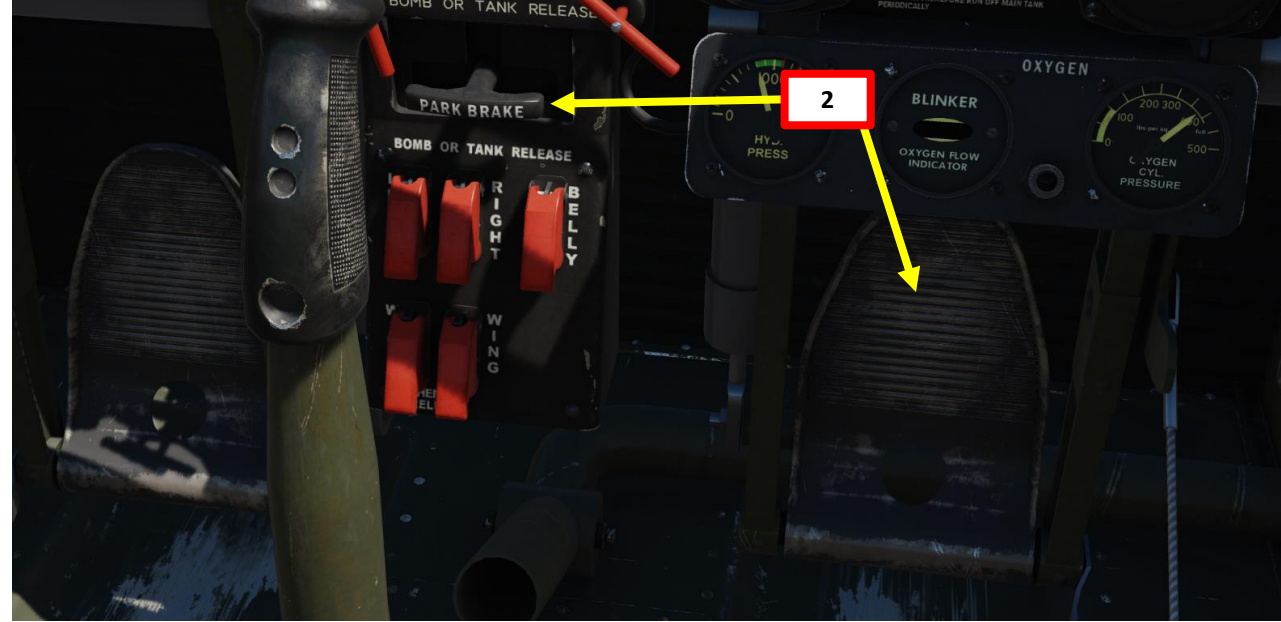

TAKEOFF PROCEDURE

1. Once you are lined up on the runway, move forward to straighten the tailwheel.
2. Lock tailwheel by setting the Tailwheel Lock Control Lever FWD.
3. Check and set Trim Tab controls
 - a) Set Aileron Trim to Neutral (N)
 - b) Set Rudder Trim to Takeoff (TO)
 - c) Set Elevator Trim:
 - If auxiliary fuel tank is empty, set elevator trim to Neutral (N).
 - If fuel is present in the auxiliary fuel tank, the center of gravity of the aircraft is shifted aft, which requires Nose Heavy (NH) trim. Set elevator trim to approximately 0.75 inch NH (Nose Heavy) forward of Neutral (N).

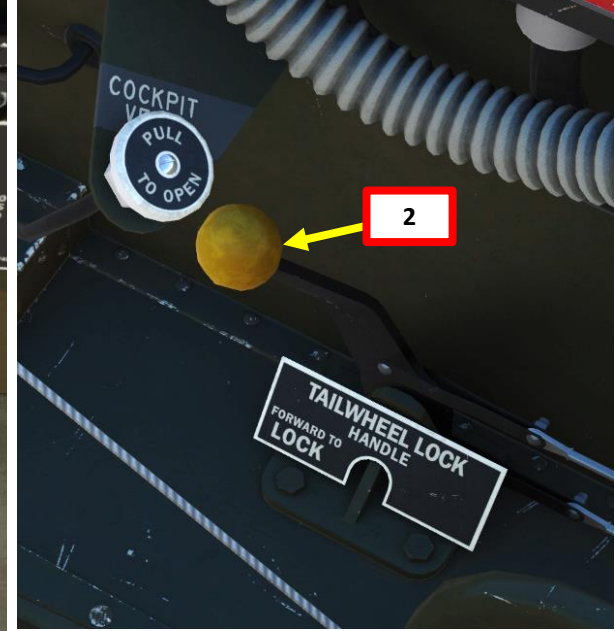
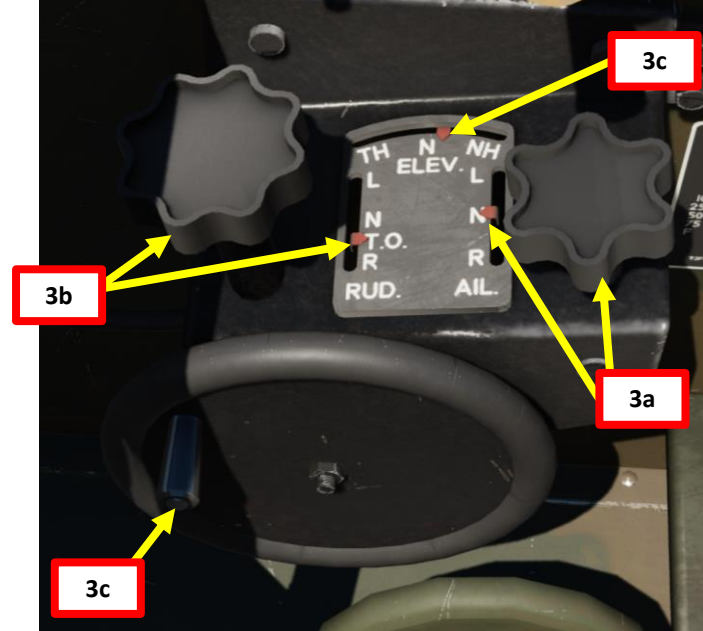

TAKEOFF PROCEDURE

4. Close Canopy using either the Canopy Lock Lever or the Canopy (Electrical Control) Switch.

Canopy (Electrical Control) Switch

- AFT: Opens Canopy
- MIDDLE: OFF
- FWD: Closes Canopy

Canopy Lock Lever

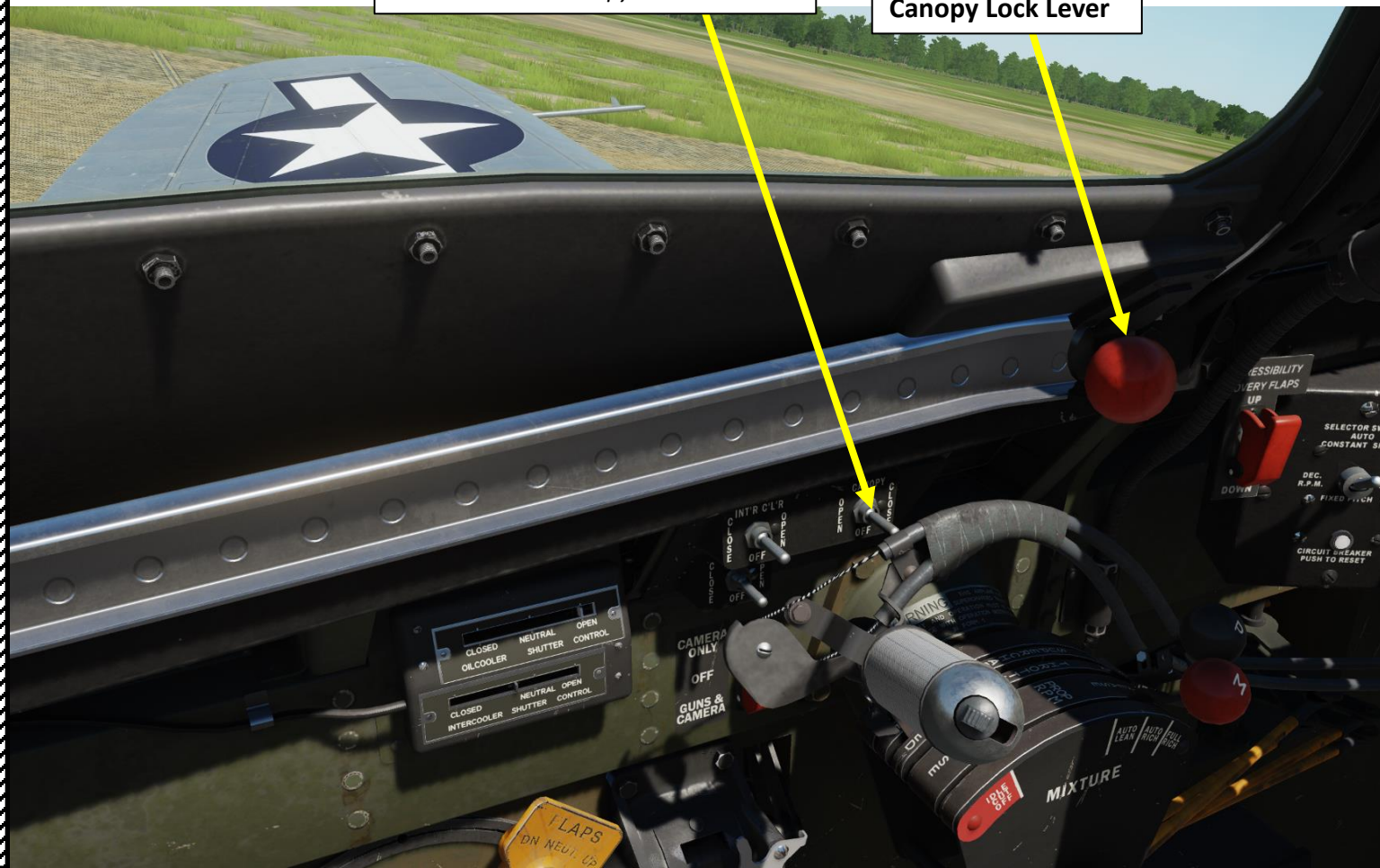

TAKEOFF PROCEDURE

- 5. Set flaps for takeoff using the Flaps Control Lever
 - a) For heavy configurations (bombs equipped) or abnormally short runways, set flaps to 20 deg by setting the flaps lever AFT to DN (Down) until the flaps position indicator on the wing indicates 20. Then, set flaps lever to MIDDLE (Neutral) position to lock flaps into position.
 - b) For normal configurations (no bombs equipped), set flaps UP by setting the flaps lever FWD (UP).

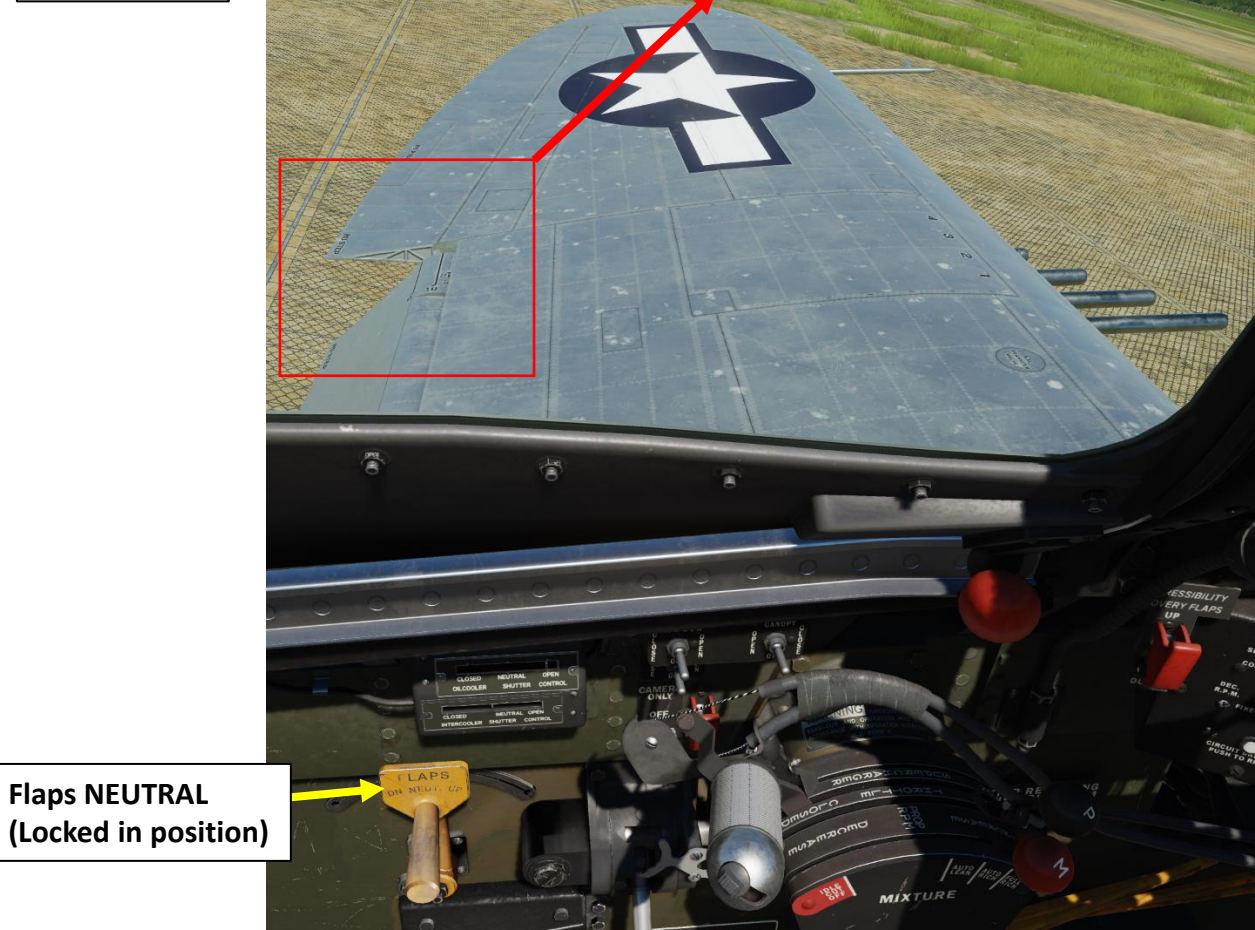

Flaps DOWN

5a

20 degrees

Flaps NEUTRAL (Locked in position)

5b

TAKEOFF PROCEDURE

6. Verify Intercooler Shutters are in the NEUTRAL position.
7. Verify Oil Cooler Shutters are in the NEUTRAL position.
8. Close Cowl Flaps Half-way by pushing IN the Engine Cowl Flaps Handle and releasing it when cowl flaps are in the desired position.
9. Verify Mixture Control (M) Lever is set to AUTO RICH.
10. Set Turbosupercharger (B) Lever – FULLY AFT (OFF). This is done to avoid power loss during takeoff (see the ENGINE & FUEL MANAGEMENT section) and to avoid carburetor overheat during hot weather takeoff (temperature greater than 35 deg C).
11. Set Propeller RPM Control (P) lever – FULLY FWD (INCREASE).

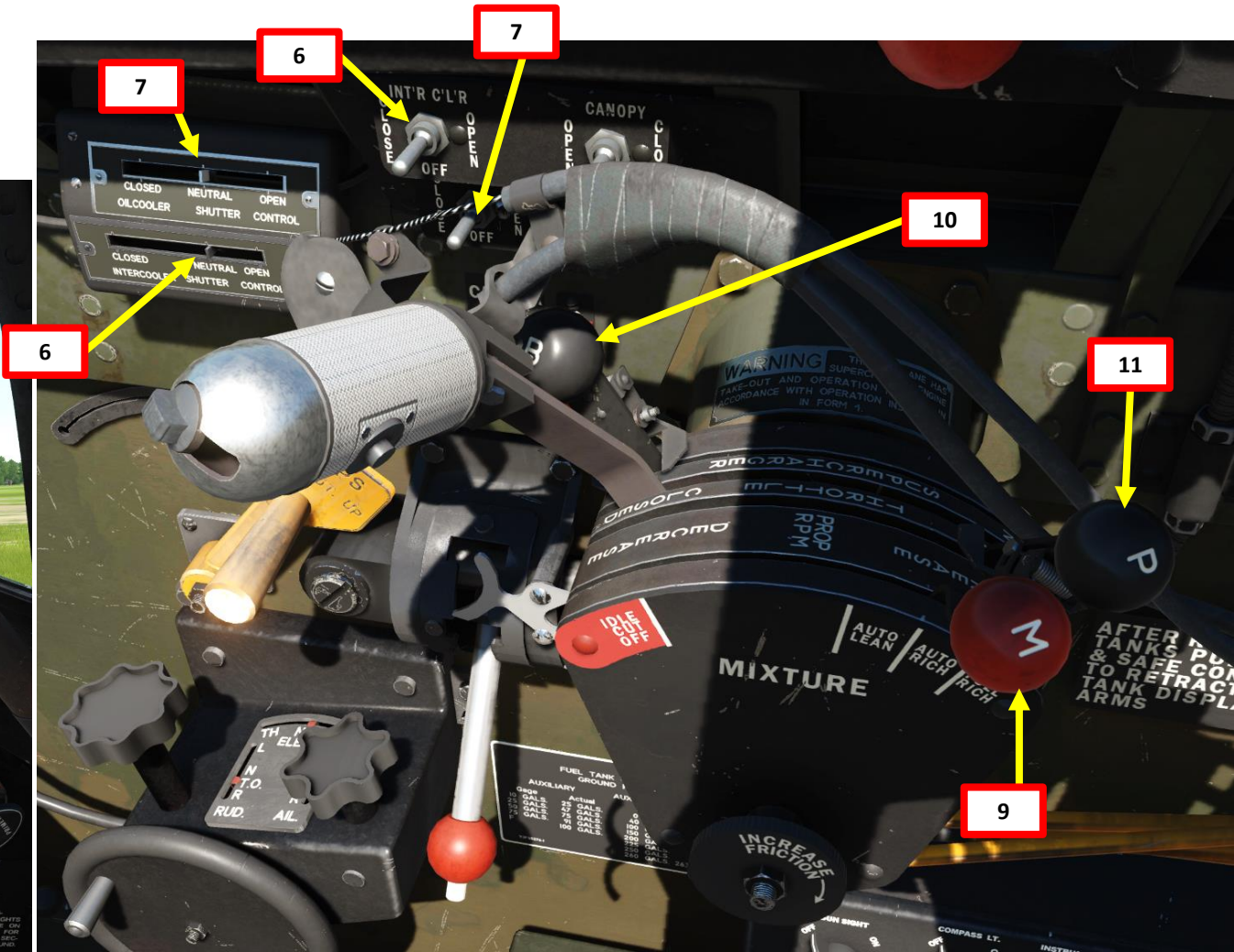

TAKEOFF PROCEDURE

12. Hold Wheel Brakes and throttle up to 30 in Hg manifold pressure.
13. Once engine parameters are stabilized, release wheel brakes and throttle up smoothly. Controlled RPM should be 2700 RPM.
 - You can takeoff either without or with using the Turbosupercharger (B) Lever Boost depending on your takeoff weight and the required attainable manifold pressure. If using (B) Lever, always advance throttle first.
 - Not using the Turbosupercharger on takeoff will generate a manifold pressure of up to 45 in Hg, which is generally sufficient for normal takeoff. Using maximal Turbosupercharger on takeoff will generate more than 52 in Hg (takeoff redline).
 - **Do not exceed 52 in Hg of manifold pressure on takeoff.**
14. Apply right rudder to counter the engine torque. Do **NOT** use toe brakes to counter the torque.
15. The heavy weight of the P-47 means that it requires a longer takeoff run than most other WWII fighters; you may be tempted to exceed the takeoff redline (52 in Hg) in order to build up speed: **don't do it!** Your plane will get off the ground just fine using prescribed power limits.
16. The P-47 flies off the ground from a 3-point position at about 100 mph. When you feel the tail rising, adjust the stick to raise the tail about 6 inches from the ground.
17. Stay on the ground until reaching a speed of around 110 mph, then smoothly pull back on the stick to lift the plane off the runway. The raised tail and added speed give you much better rudder control in case of trouble.



Takeoff power redline (do not exceed!)

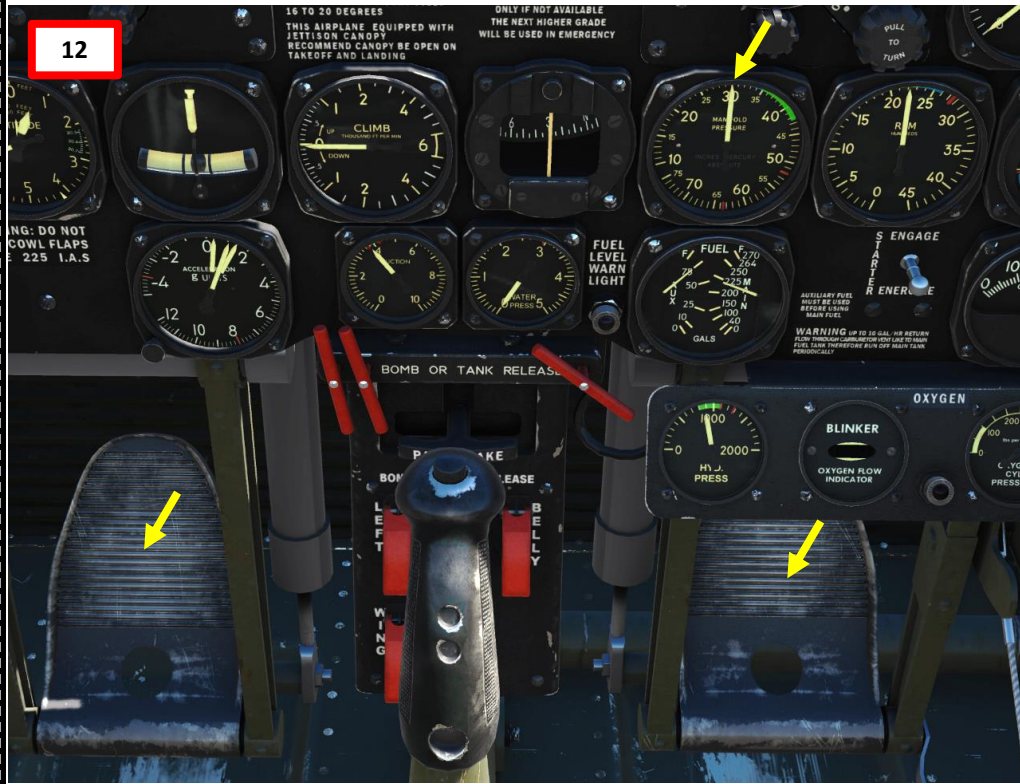

TAKEOFF PROCEDURE

18. Aircraft rotation should occur at approx. 120 mph. Do **NOT** apply brakes to stop rotation of the wheels while in the air; doing so may seize brake disks and leave you a nasty surprise on landing.



TAKEOFF PROCEDURE

19. Raise the landing gear as quickly as possible.
 - The Green LDG WARNING LIGHT indicates the gear is down and locked
 - The Red LDG WARNING LIGHT indicates the gear is in transition
 - When both the Green and Red LDG WARNING LIGHTS are extinguished, the gear is retracted and locked.
20. If using flaps during takeoff, develop at least 145 mph before rising flaps. Flaps should be extended until you reach 500 ft altitude. Then, carefully raise flaps by moving the yellow handle to the UP position.



Gear Down & Locked



Gear In Transition



Gear Up & Locked

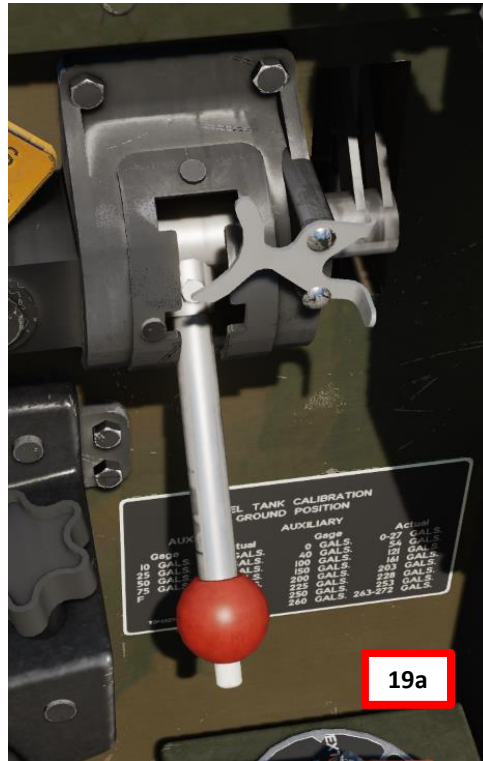

19a

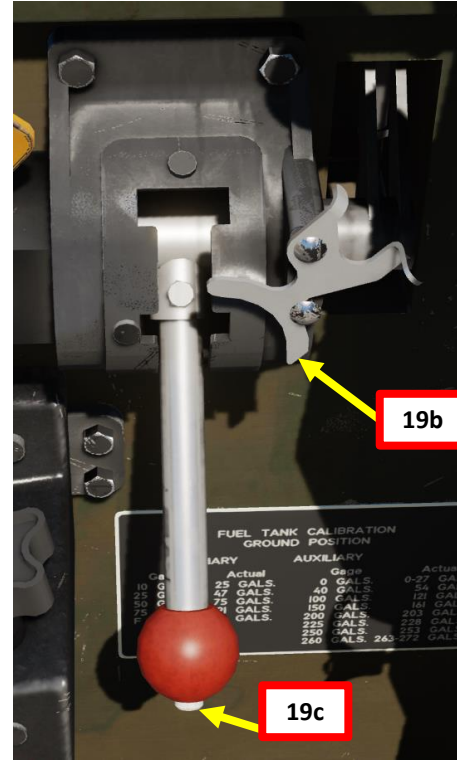

19c

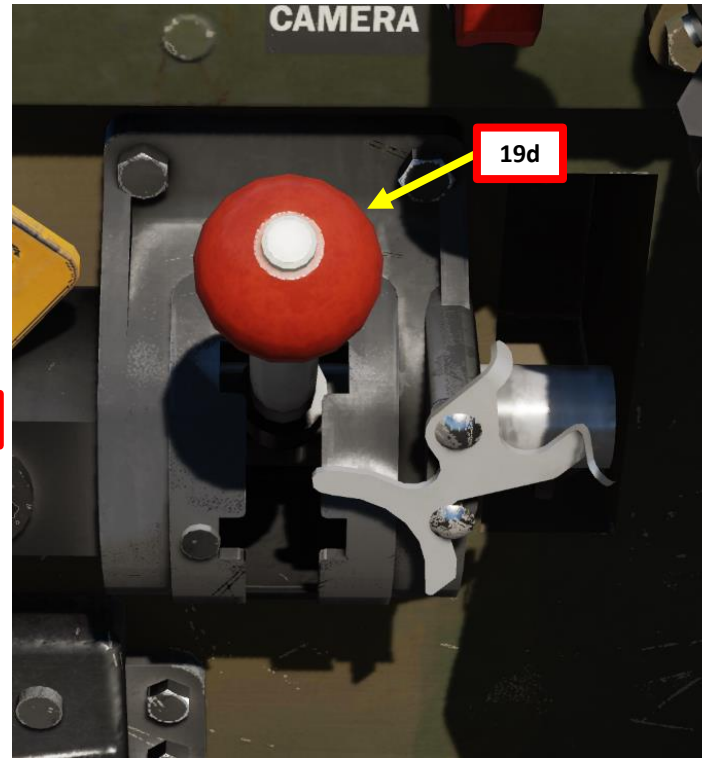

19d

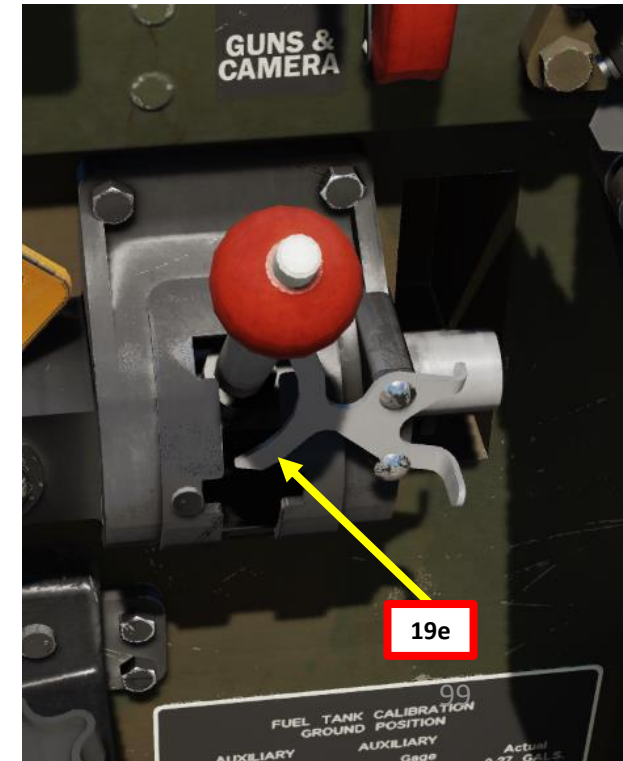

19e

TAKEOFF PROCEDURE



CLIMB

21. Adjust cowl flaps as needed to cool the cylinders; about 1/3 open is about right for climbing. CHT (Cylinder Head Temperature) should be maintained at or below 260 deg C. Check CHT frequently; if CHT goes over 260 deg C, increase airspeed to provide more airflow to cool the engine cylinders.
22. Throttle down to 42 in Hg manifold pressure.
23. Adjust Propeller RPM Control (P) lever to 2550 RPM.
24. Set climb speed between 150 and 165 mph, 160 mph being the optimal climb speed.
25. Trim the aircraft as required for climbing; you
26. If fuel is available in the auxiliary tank, set Fuel Selector Valve Handle from MAIN to AUXILIARY after reaching a safe altitude (after roughly 10 min of flight). This is the fuel tank you will want to use first since the aux tank fuel offsets your aircraft's center of gravity and reduces your aircraft's longitudinal stability.
27. If aircraft airspeed is above 225 mph, fully close cowl flaps as they will cause turbulence..



LANDING PROCEDURE

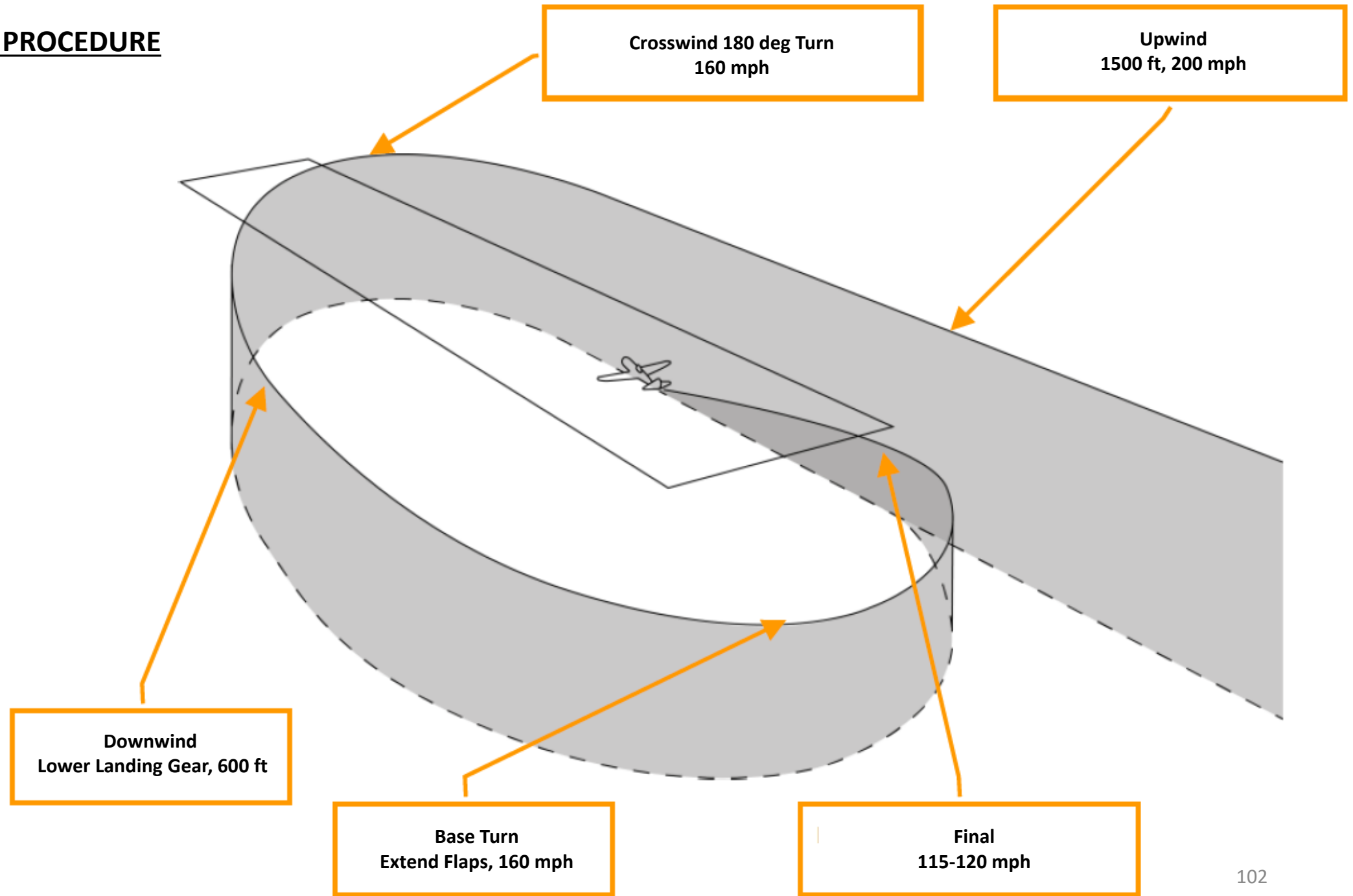

LANDING PROCEDURE

1. Verify Propeller Governor Switch is set to CONSTANT SPEED AUTO (UP)
2. Adjust Propeller RPM Control (P) lever to set a RPM of 2550.
3. Verify Mixture Control (M) Lever is set to AUTO RICH
4. Verify Intercooler Shutters are in the NEUTRAL position.
5. Verify Oil Cooler Shutters are in the NEUTRAL position.
6. Close Cowl Flaps completely by pushing IN the Engine Cowl Flaps Handle and releasing it when cowl flaps are in the desired position. This will prevent engine overcooling at low throttle settings.

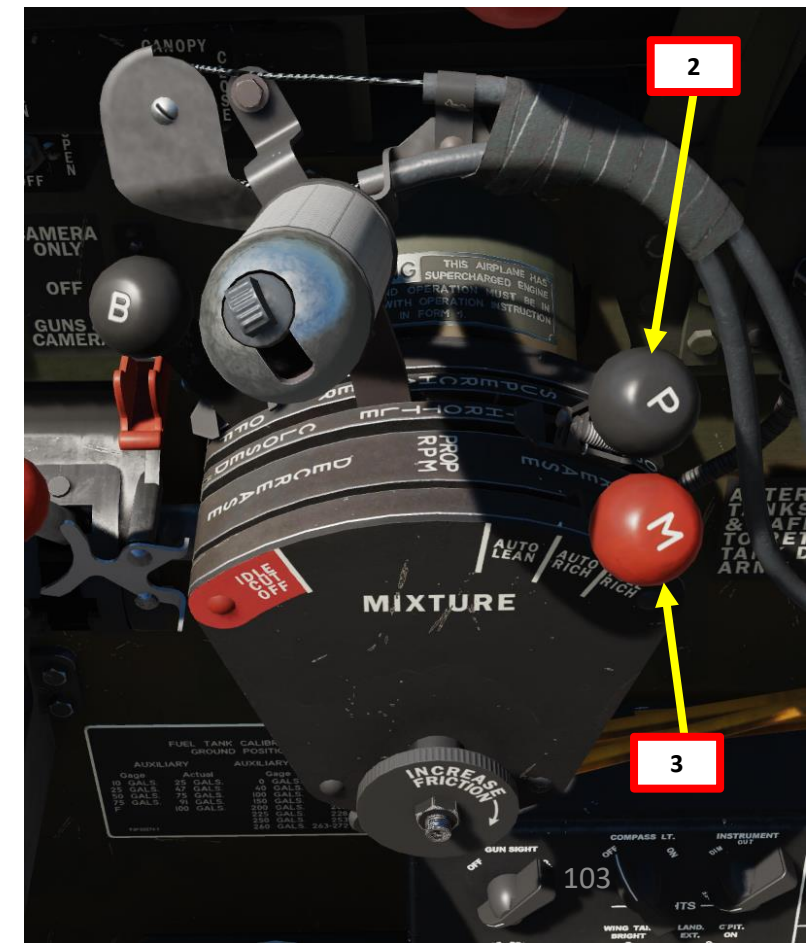
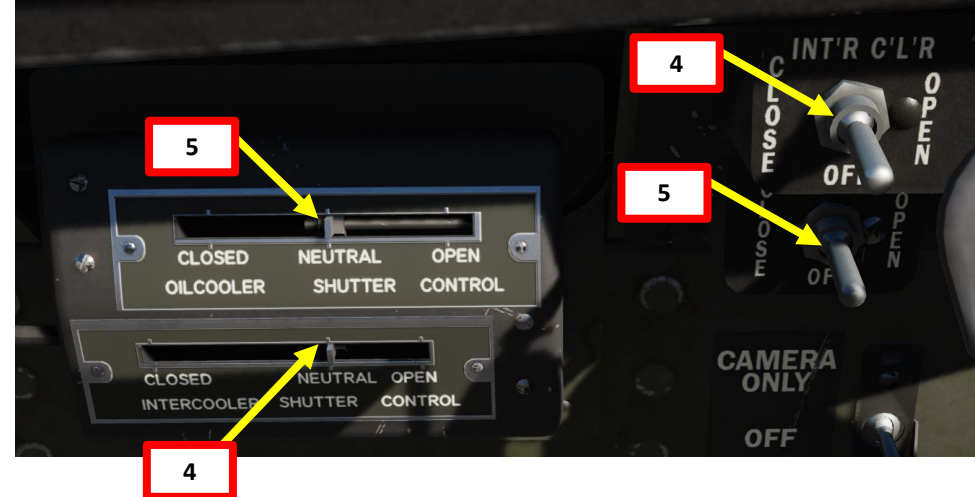

LANDING PROCEDURE

7. Verify that throttle and Turbosupercharger (B) levers are not interconnected, then set Turbosupercharger (B) lever to OFF position (AFT).

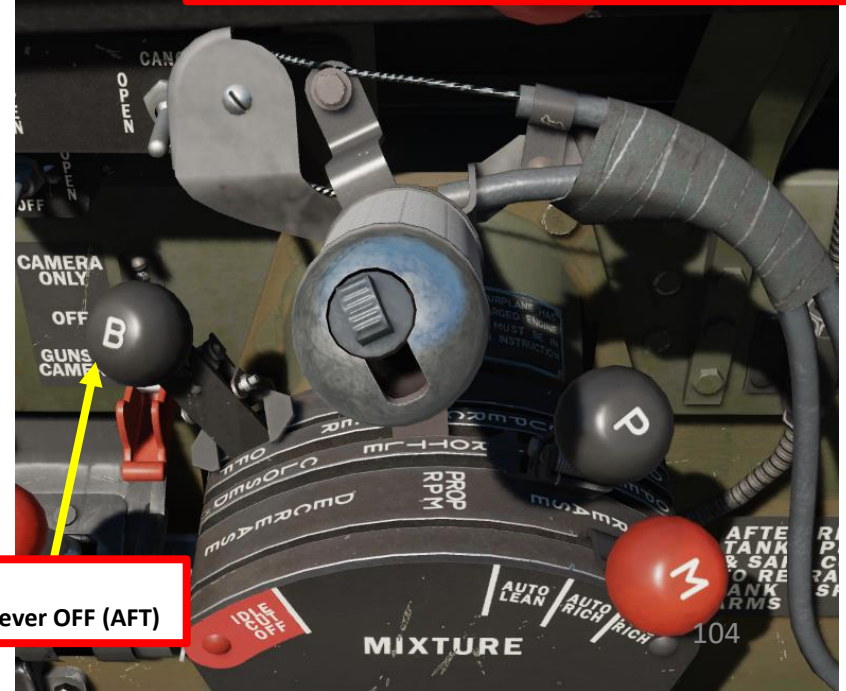

LANDING PROCEDURE

8. Approach airfield at 1500 ft and 200 mph
9. After passing the reverse end of the runway, make a 180-degree turn (crosswind).
10. Reduce speed to 160 mph
11. Lower landing gear and check the gear warning lights.
 - Never lower landing gear above 200 mph, and never exceed 250 mph with the landing gear down.
12. Trim plane by using elevator trim.
13. Reduce altitude to 600-800 ft.
14. Lock tailwheel by setting the Tailwheel Lock Control Lever FWD.



Gear Up & Locked



Gear In Transition



Gear Down & Locked

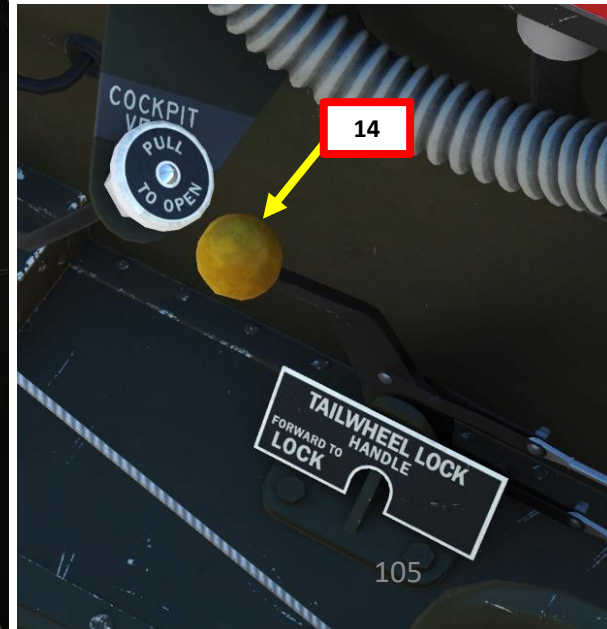
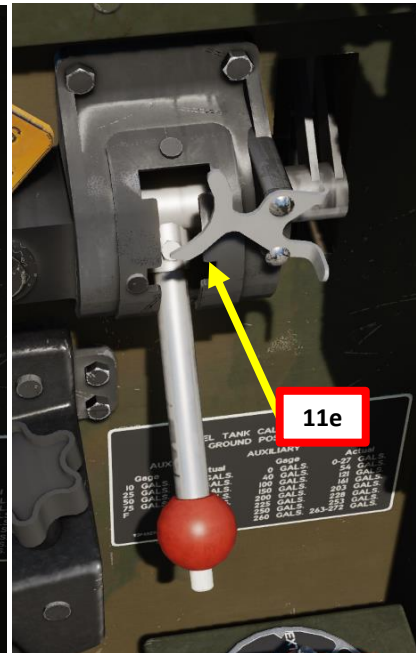
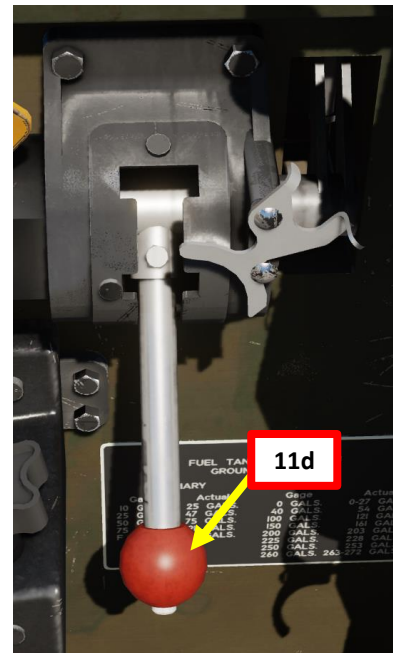
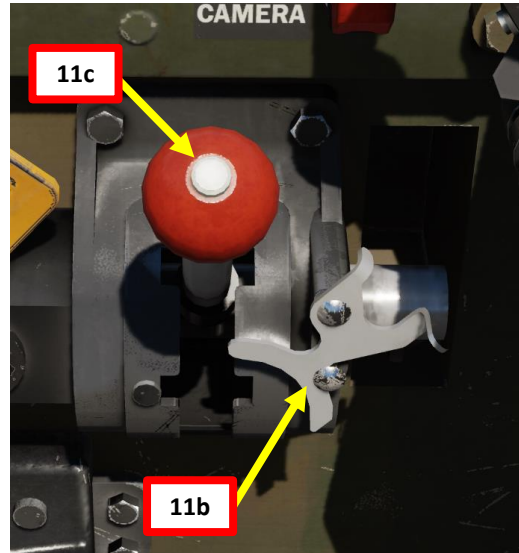
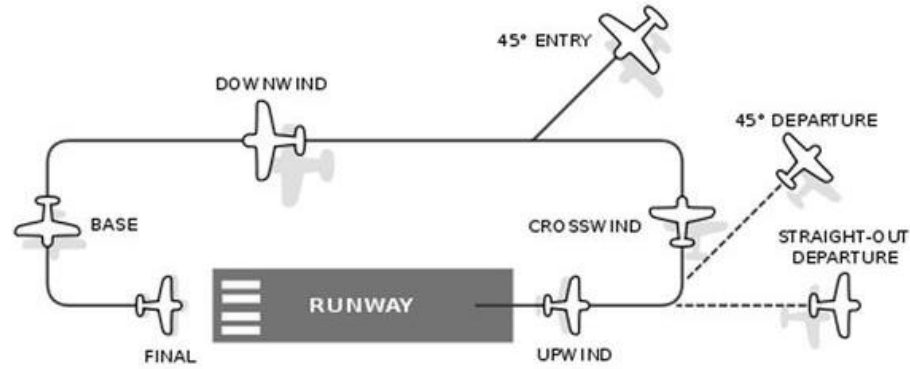

LANDING PROCEDURE

15. Turn on Wing and Tail Navigation Lights and extend Landing Light.
16. When turning on final approach (base leg) and airspeed is below 160 mph, reduce altitude to 500 ft.
17. Extend flaps fully by setting the flaps lever AFT to DN (Down) until the flaps position indicator on the wing indicates 40 deg.
 - Never lower flaps above 195 mph
18. Maintain approximately 150 mph in the traffic pattern.
19. Once lined up on final with flaps lowered, maintain approx. 115-120 mph. Always make sure to keep a little bit of excess power during the approach or you will start sinking; the Thunderbolt is a very heavy plane.
20. Just before you are about to cross the runway threshold, cut the throttle.
21. Just before touchdown, break the glide with a controlled flare and approach so as to land within the first third of the runway in a 3-point attitude.
22. Hold the aircraft in the 3-point attitude just above the runway until flying speed is lost and the plane sets down at approx. 90 mph.

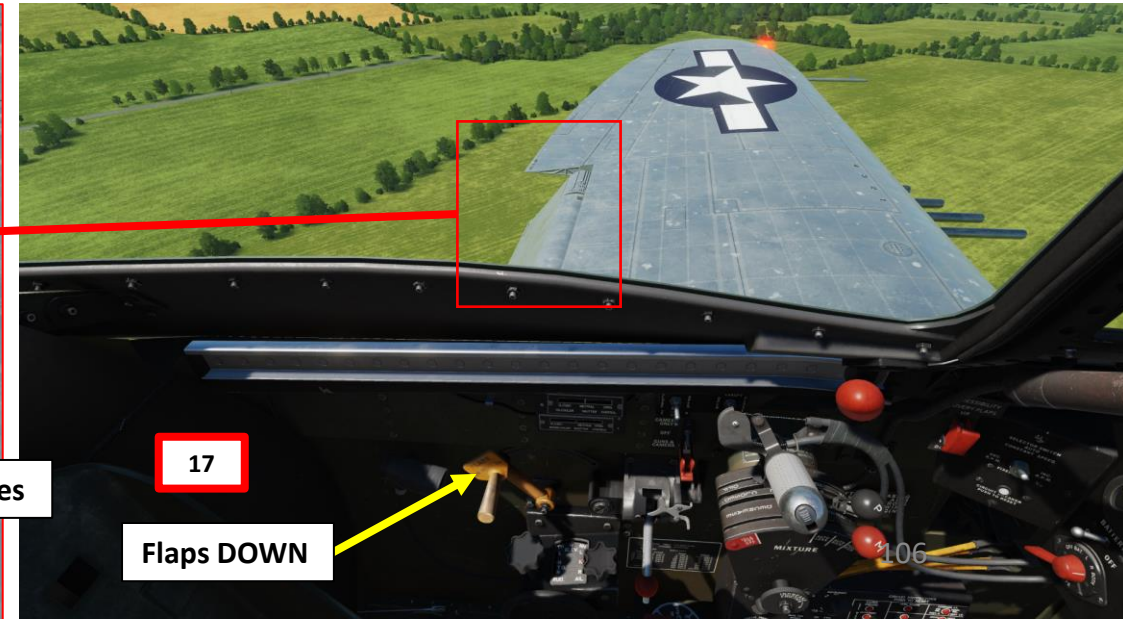
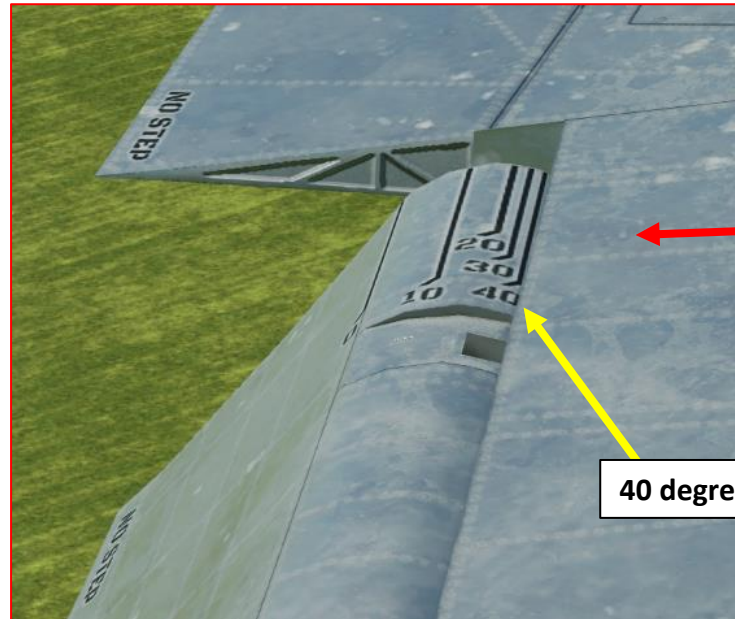

LANDING PROCEDURE

PART 6 - LANDING



FLAP WARNING
DO NOT LOWER FLAPS ABOVE 195 MPH
BEST SETTING FOR TAKE OFF WITH
HEAVY LOAD OR SHORT FIELD
16 TO 20 DEGREES
THIS AIRPLANE EQUIPPED WITH
JETTISON CANOPY

SERVICE THE AIRPLANE
WITH 100 OCTANE FUEL
ONLY IF NOT AVAILABLE
THE NEXT HIGHER GRADE
WILL BE USED IN EMERGENCY

LANDING PROCEDURE



LANDING PROCEDURE

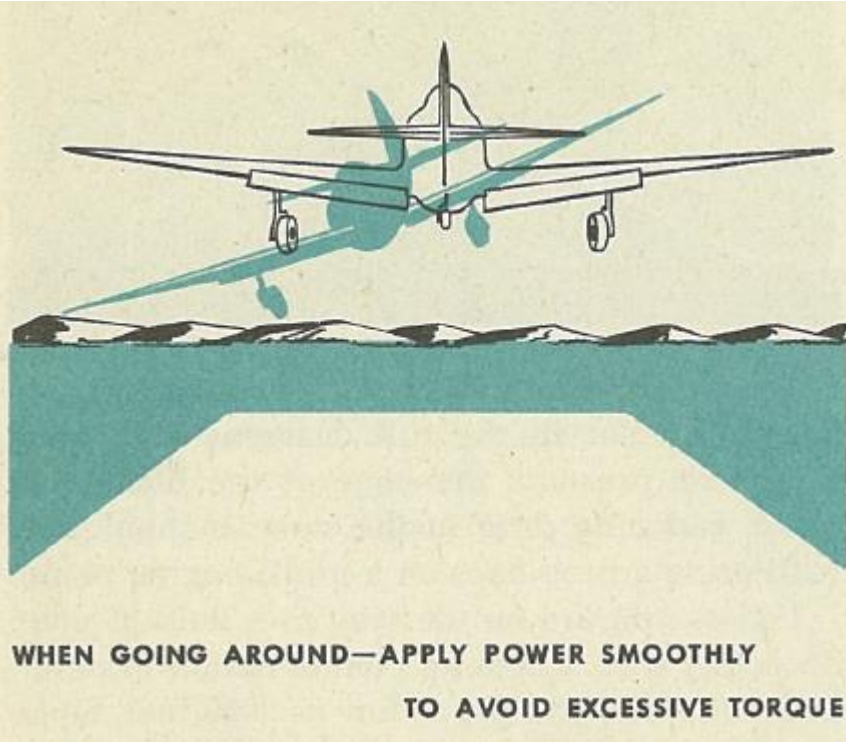

Hydraulic Failure

If your wheels won't come down, don't try to pump them down with the hydraulic hand pump. It isn't necessary, and you need the remaining hydraulic pressure for your flaps.

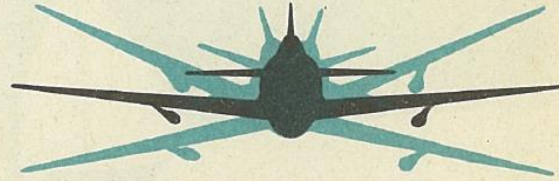

Place the landing gear lever in the DOWN position, rock your plane and execute turns, dives, and pull-outs until your wheels are down. Fly over the field and ask the tower for a check.

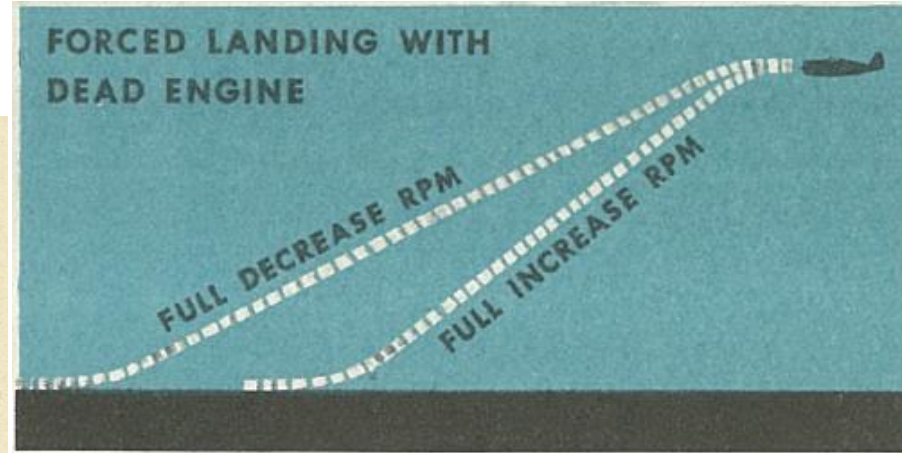

3 RULES FOR ANY FORCED LANDING

1. DON'T STALL
2. DON'T EVER STALL
3. DON'T NEVER EVER STALL*

* Ungrammatical, but still true.

NORMAL LANDING

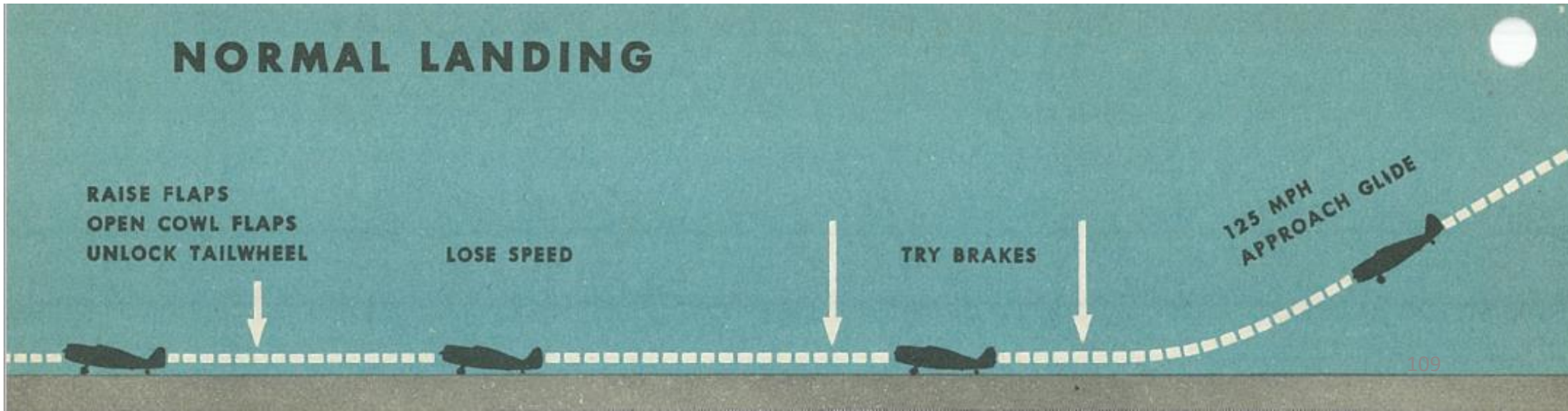

PRATT & WHITNEY R-2800 DOUBLE WASP

The P-47 is powered by the Pratt & Whitney R-2800-59W Double Wasp; a twin-row, 18-cylinder, air-cooled radial aircraft engine with a displacement of 2,800 in³ (46 L). The Double Wasp is part of the long-lived Wasp family of engines, and the R-2800 designation means "Radial engine with total capacity of 2800 cubic inches". This 2,000 hp engine is equipped with a single-speed mechanical compressor, a General Electric turbosupercharger and a Curtiss Electric four-bladed propeller.





PRATT & WHITNEY R-2800 DOUBLE WASP

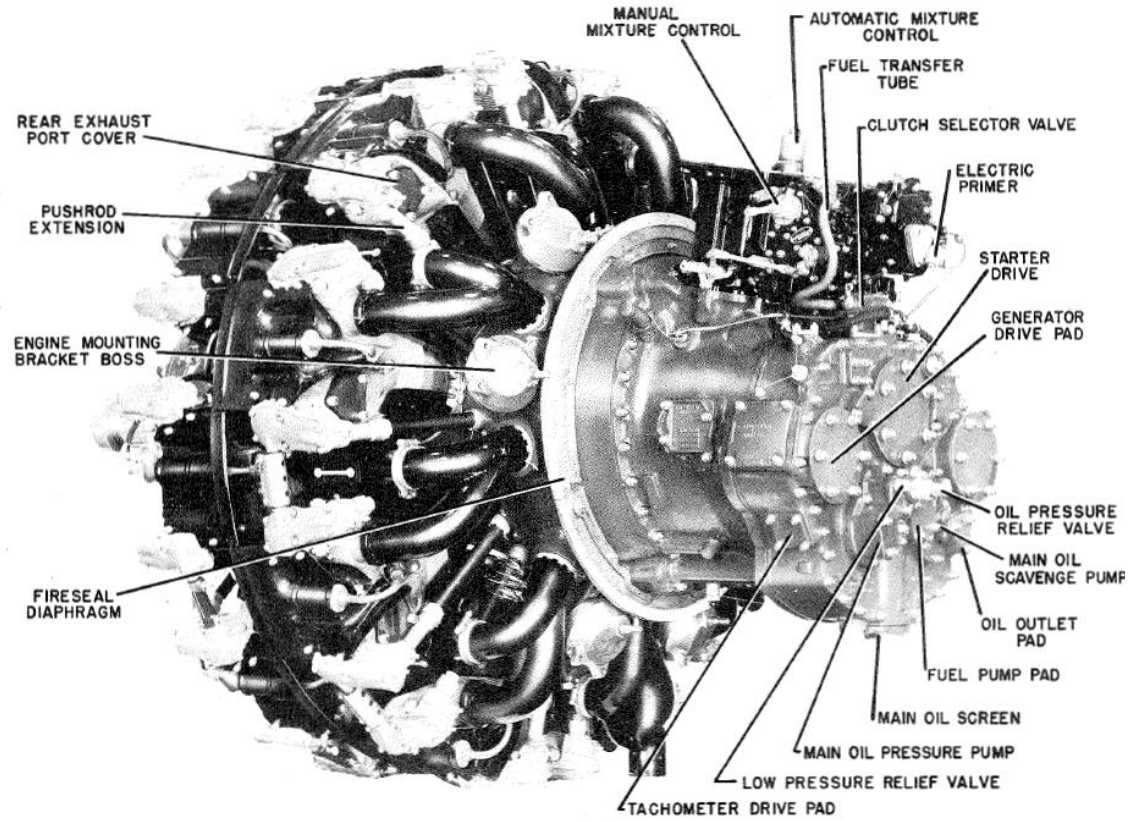

Left Rear View of Engine

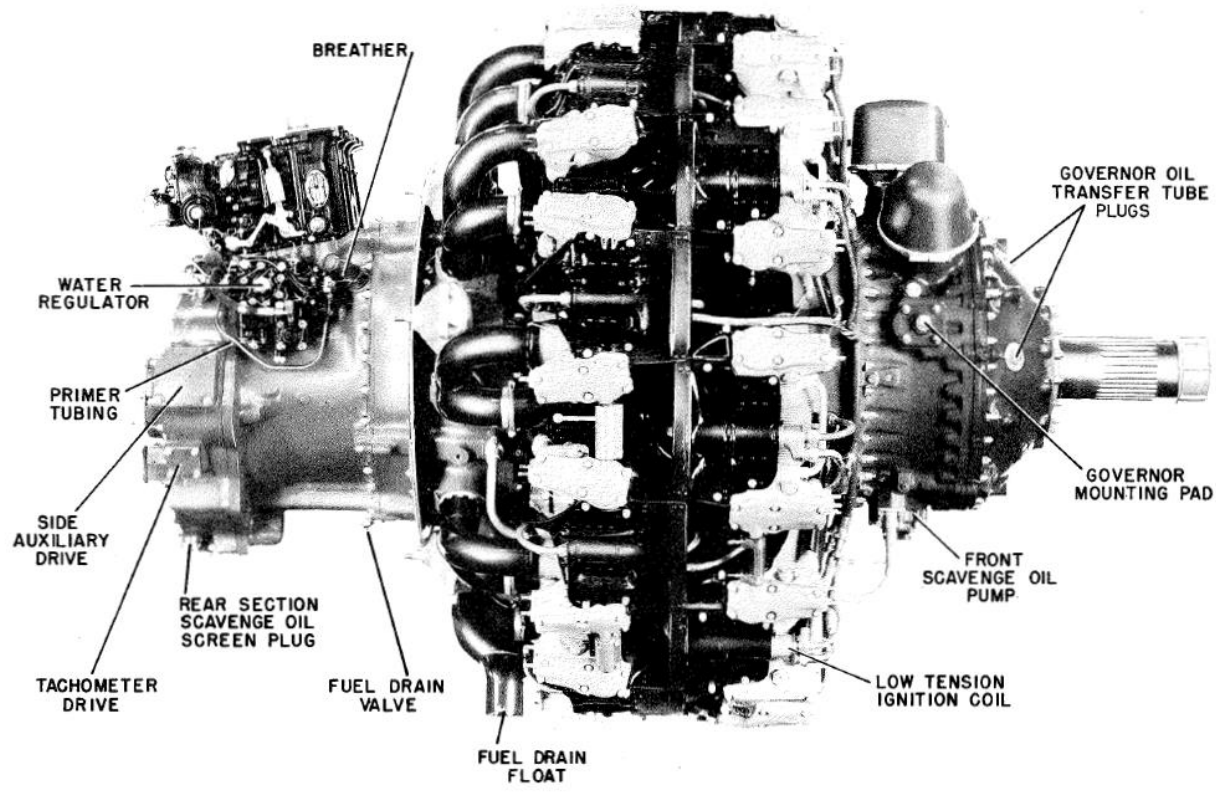

Right Side View of Engine

PRATT & WHITNEY R-2800 DOUBLE WASP

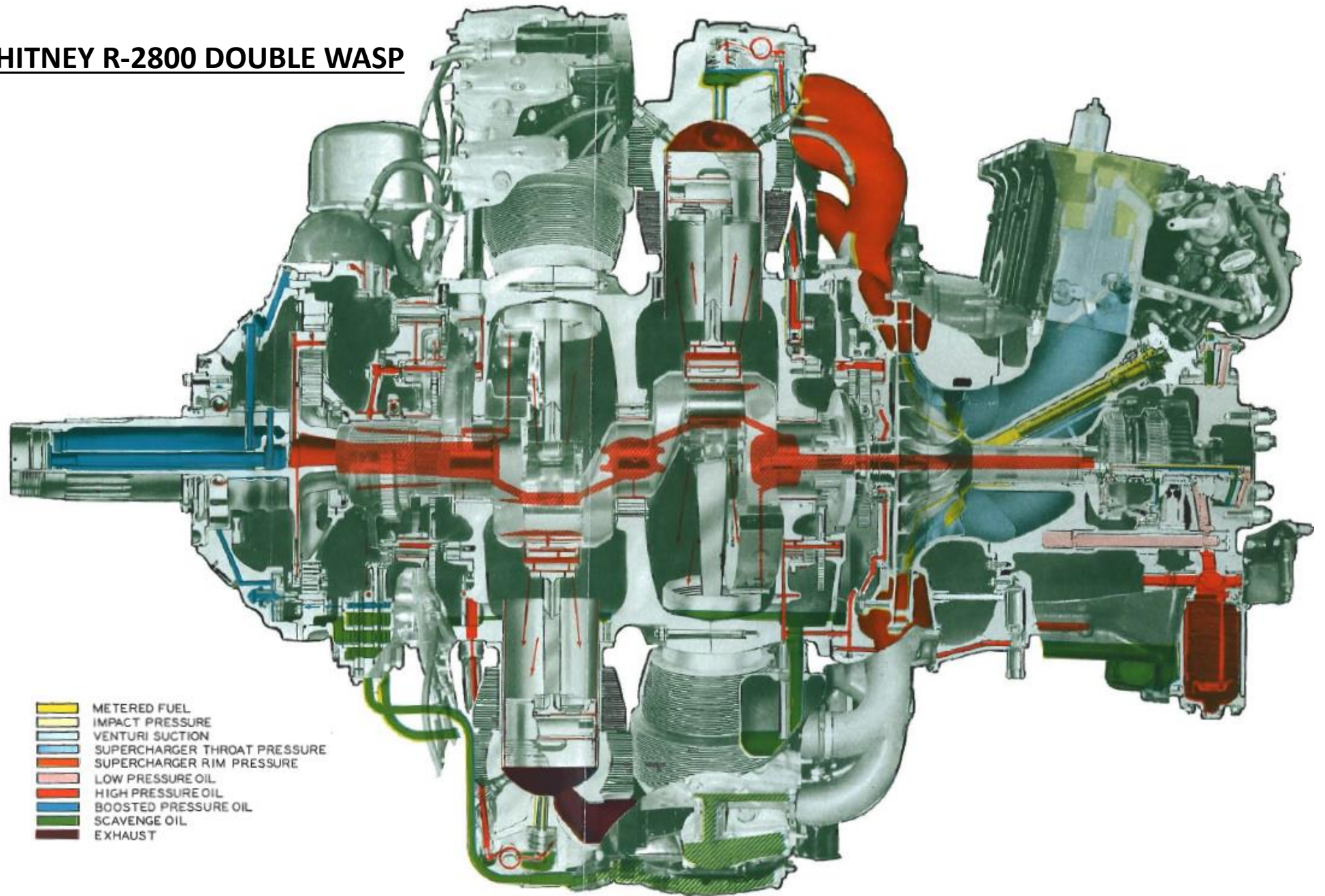

- METERED FUEL
- IMPACT PRESSURE
- VENTURI SUCTION
- SUPERCHARGER THROAT PRESSURE
- SUPERCHARGER RIM PRESSURE
- LOW PRESSURE OIL
- HIGH PRESSURE OIL
- BOOSTED PRESSURE OIL
- SCAVENGE OIL
- EXHAUST

Sectional View of Fuel/Air, and Oil System



P-47D
THUNDERBOLT

PART 7 - ENGINE & FUEL MANAGEMENT

PRATT & WHITNEY R-2800 DOUBLE WASP

Here is a nice video of what the engine looked like internally:
<https://youtu.be/EyPvpy4dgg>

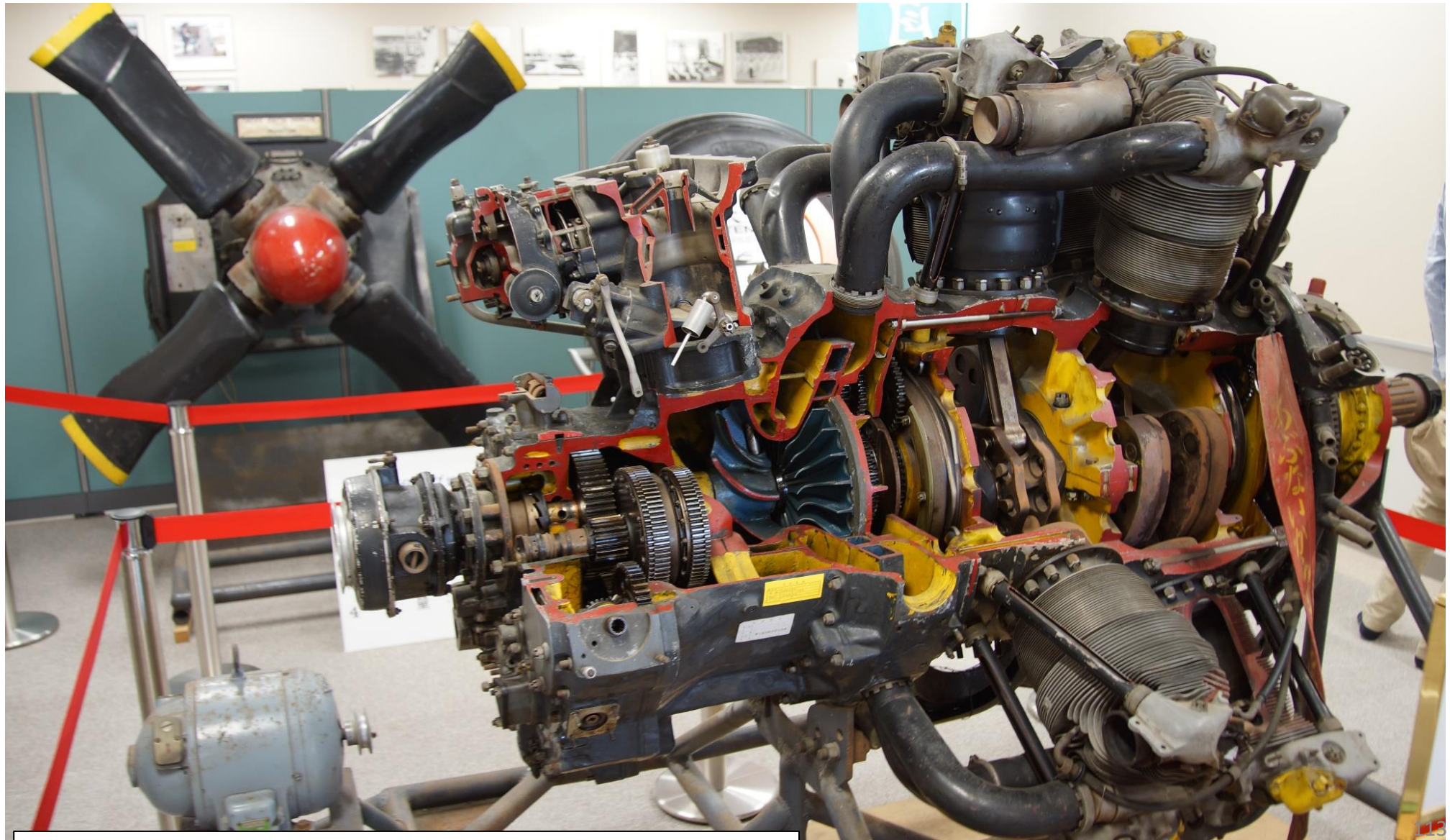

R-2800-71 engine cutaway model at Archive room of JASDF Miho Air Base (Photo by Hunini)



ENGINE LIMITS & PARAMETERS

- Manifold Pressure:
 - 42 in Hg: Max Continuous Power
 - 52 in Hg: Max Takeoff Power
 - 64 in Hg: War Emergency Power
- Propeller RPM: Max 2800 RPM
- Oil Pressure: Min 50 psi, Max 90 psi
- Oil Temperature: Max 105 deg C
- CHT (Cylinder Head Temperature): Min 150 deg C, Max 230 deg C
- Carburetor Air Temperature: Min 0 deg C, Max +50 deg C
- Fuel Pressure: Min 22 psi, Max 24 psi
- Vacuum System Suction: 4 in Hg (Operational Range)
- Water Pressure: 25-27 psi (Operational Range when water injection is active)
- Turbosupercharger RPM: Max 22,000 RPM

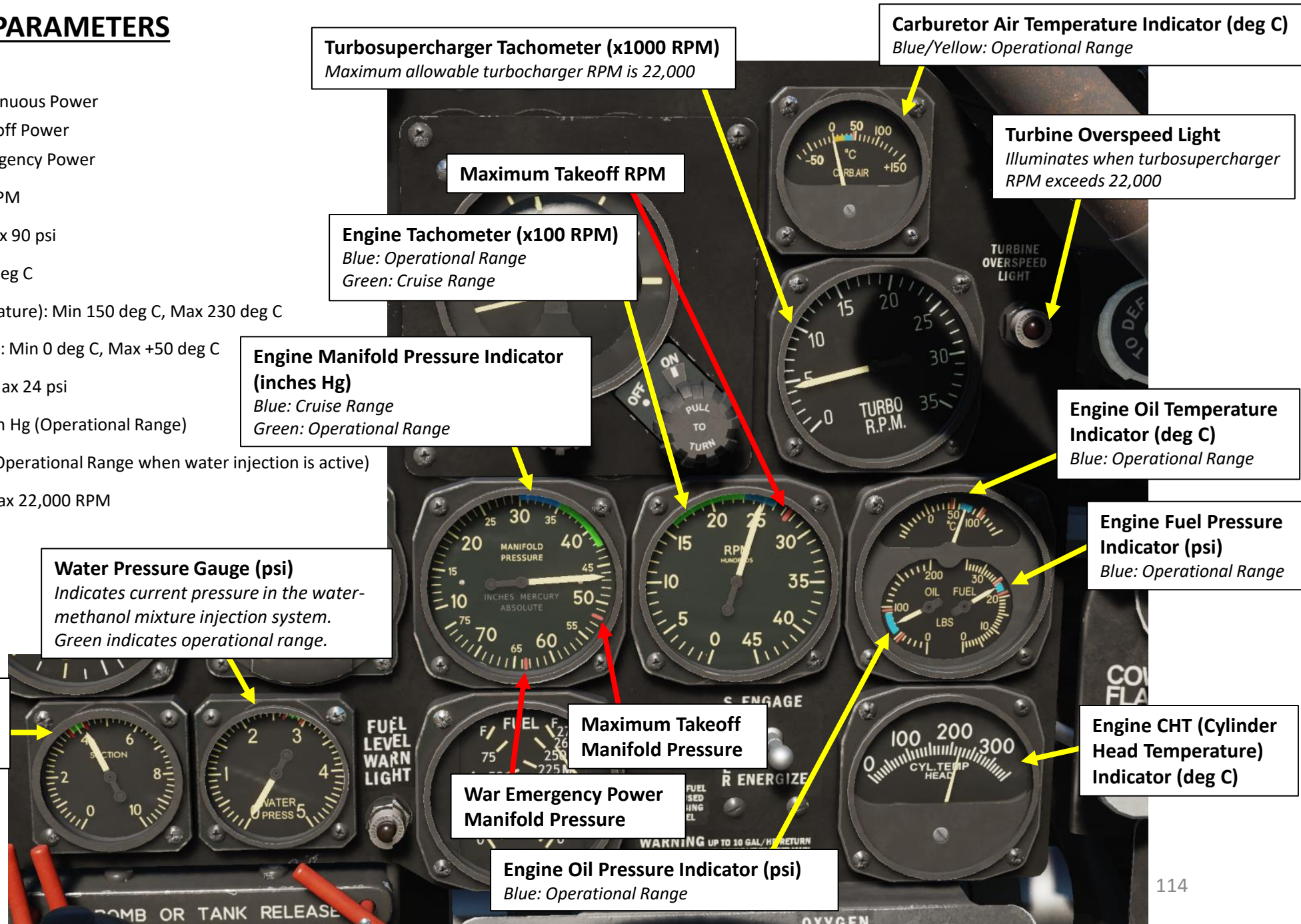

Turbosupercharger Tachometer (x1000 RPM)
 Maximum allowable turbocharger RPM is 22,000

Carburetor Air Temperature Indicator (deg C)
 Blue/Yellow: Operational Range

Turbine Overspeed Light
 Illuminates when turbosupercharger RPM exceeds 22,000

Maximum Takeoff RPM

Engine Tachometer (x100 RPM)
 Blue: Operational Range
 Green: Cruise Range

Engine Manifold Pressure Indicator (inches Hg)
 Blue: Cruise Range
 Green: Operational Range

Engine Oil Temperature Indicator (deg C)
 Blue: Operational Range

Engine Fuel Pressure Indicator (psi)
 Blue: Operational Range

Water Pressure Gauge (psi)
 Indicates current pressure in the water-methanol mixture injection system.
 Green indicates operational range.

Vacuum System Suction Gauge (inches Hg)
 Green: Operational Range

Maximum Takeoff Manifold Pressure

War Emergency Power Manifold Pressure

Engine CHT (Cylinder Head Temperature) Indicator (deg C)

Engine Oil Pressure Indicator (psi)
 Blue: Operational Range



ENGINE CONTROLS

Water Injection (Water-Methanol Mixture) Button

Oil Cooler Shutters Position Indicator

Intercooler Shutters Position Indicator

Turbocharger (Boost) Control Lever

Intercooler Shutters Control Switch
• FWD: Opens Shutters
• MIDDLE: Shutters remain in current position
• AFT: Closes Shutters

Oil Cooler Shutters Control Switch
• FWD: Opens Shutters
• MIDDLE: Shutters remain in current position
• AFT: Closes Shutters

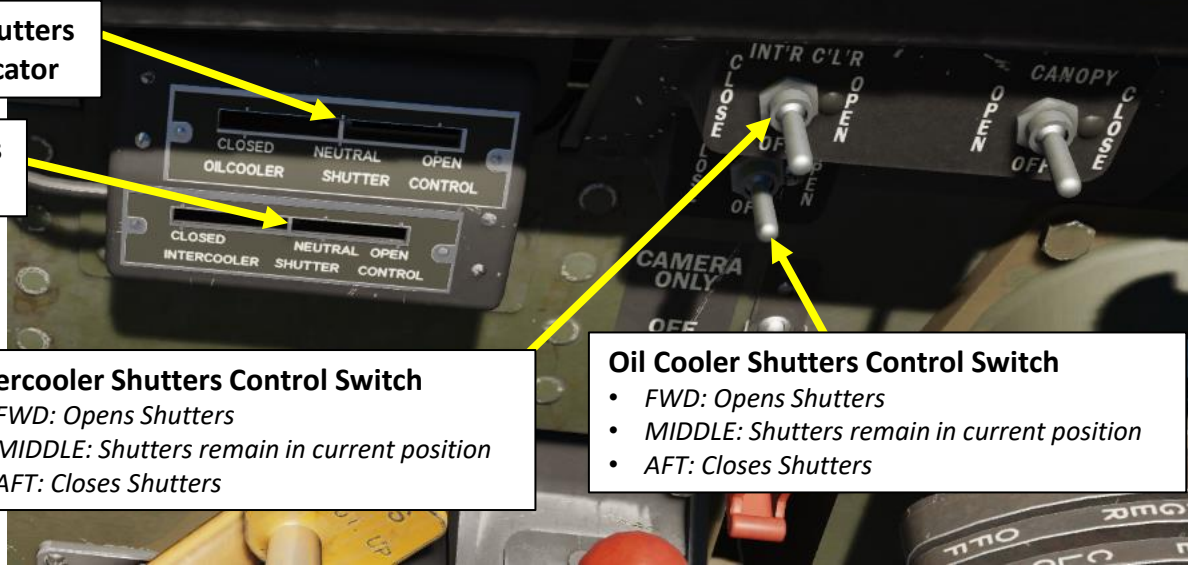
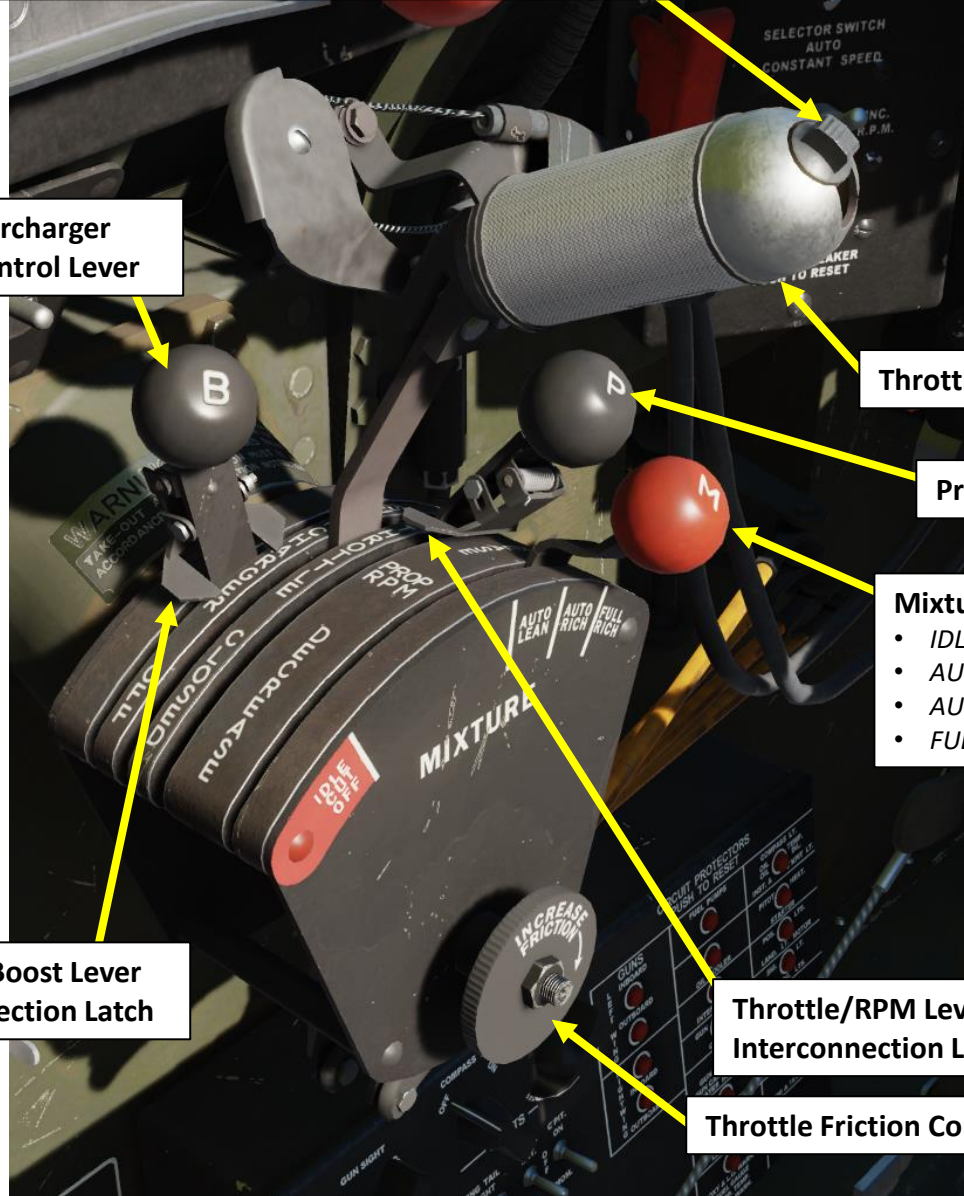

Throttle

Propeller RPM Control Lever

Mixture Lever
• IDLE CUTOFF
• AUTO LEAN
• AUTO RICH
• FULL RICH (protected by safety wire)

Throttle/Boost Lever Interconnection Latch

Throttle/RPM Lever Interconnection Latch

Throttle Friction Control

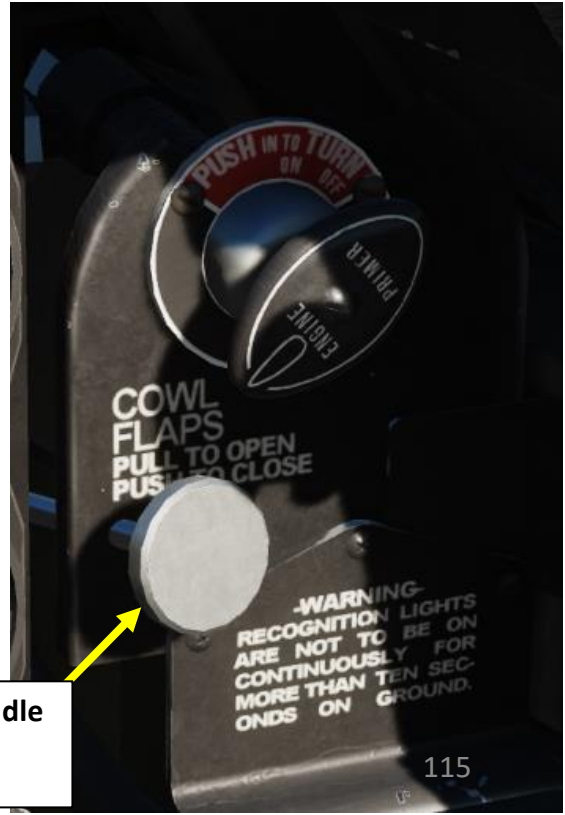

Engine Cowl Flaps Control Handle
• Pulled OUT: Opens cowl flaps
• Pushed IN: Closes cowl flaps

ENGINE CONTROLS

Take note that the Engine Cowling Flaps have no indication in the cockpit; you have to check the cowls themselves and estimate how open or closed they are.



Intercooler Shutter (Closed)



Intercooler Shutter (Open)

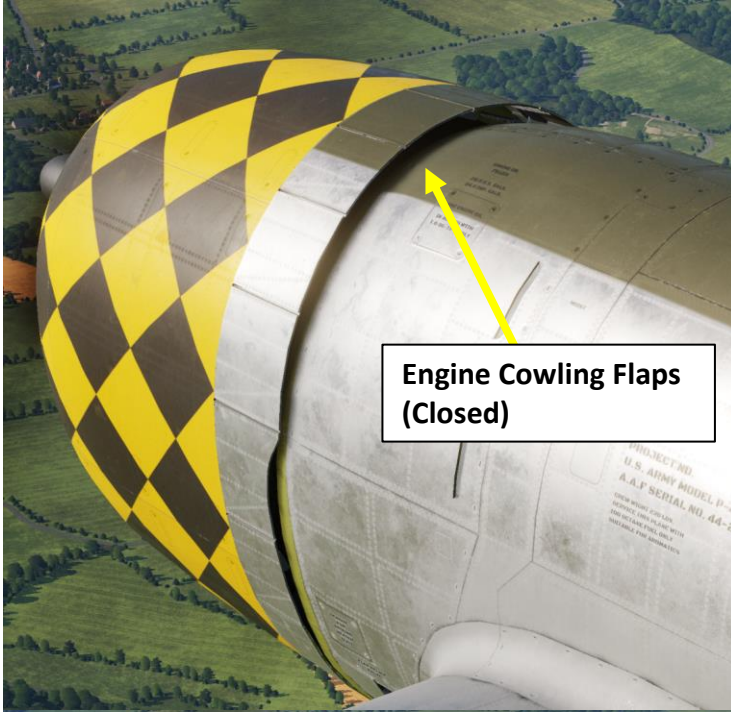

Engine Cowling Flaps (Closed)

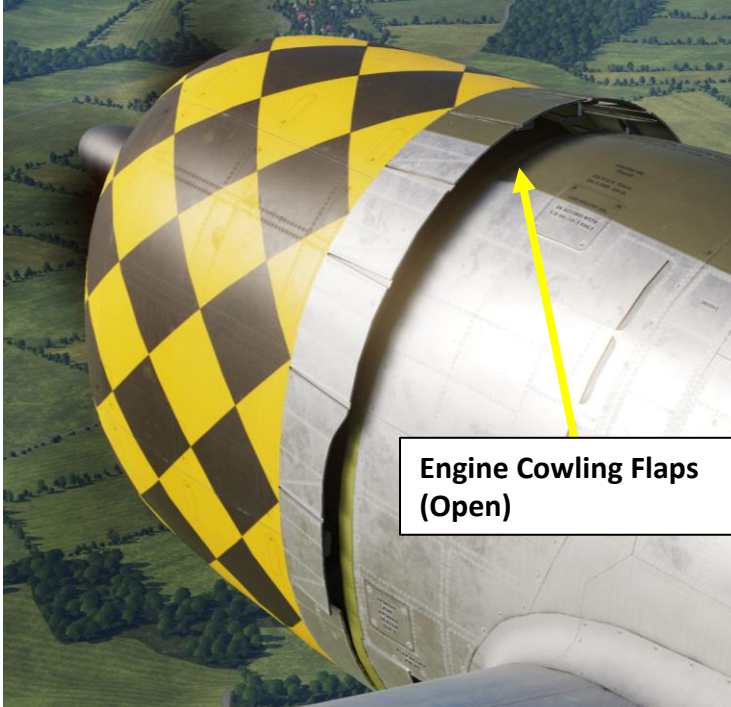

Engine Cowling Flaps (Open)

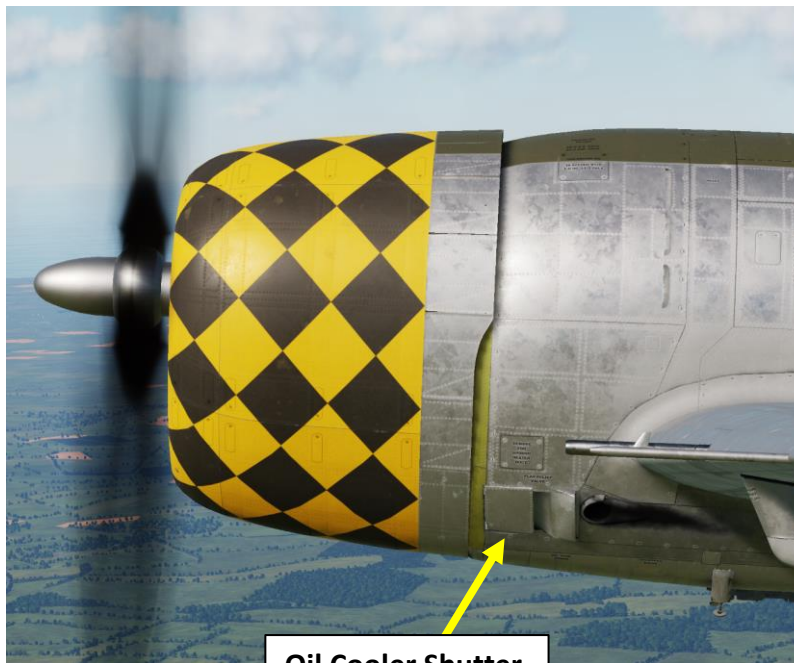

Oil Cooler Shutter (Closed)

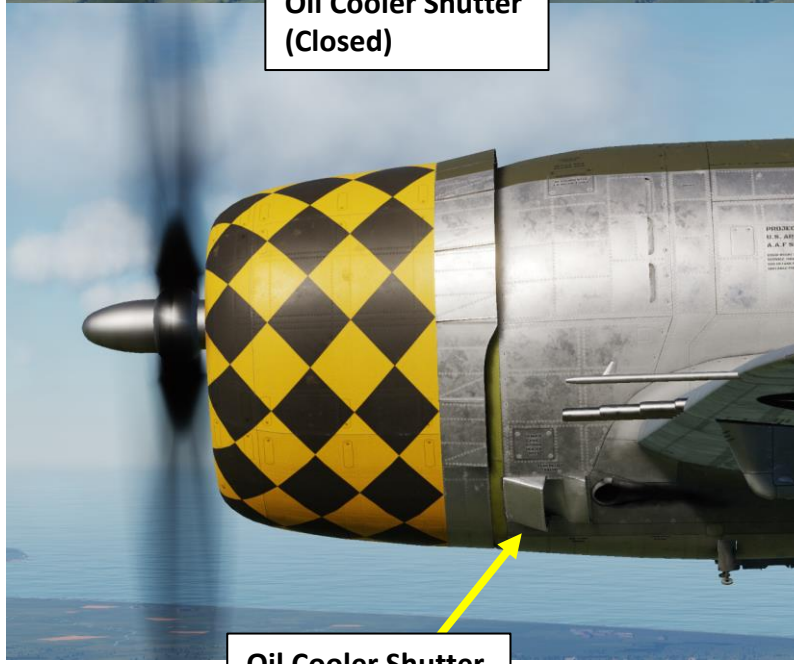

Oil Cooler Shutter (Open)

ENGINE CONTROLS

The propeller governor switch is usually left in the UP (Automatic Constant Speed) position unless the governor is running into some issues.

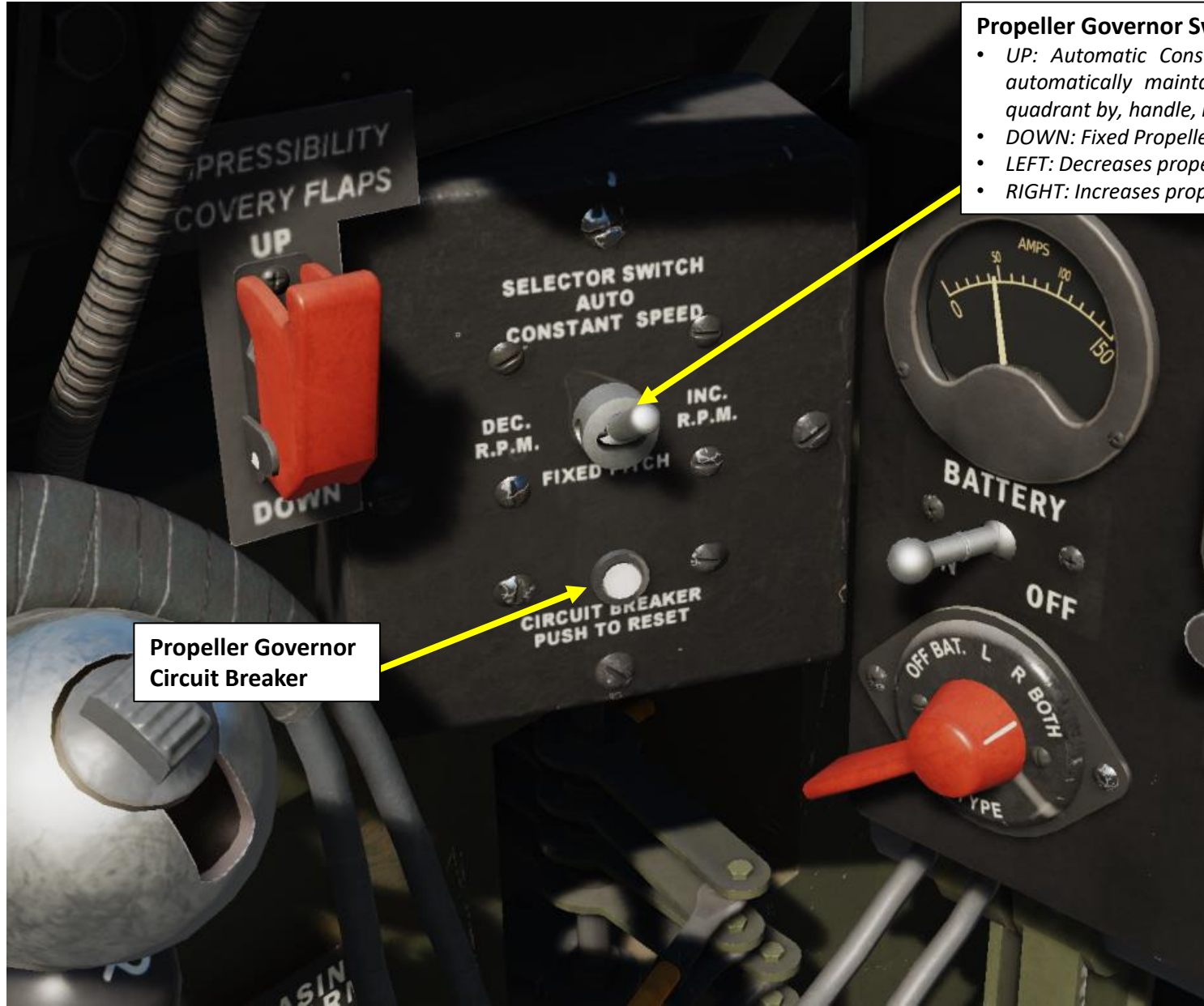

Propeller Governor Switch

- *UP: Automatic Constant Speed (propeller governor automatically maintains engine rpm as set at the quadrant by handle, marked as P – Propeller)*
- *DOWN: Fixed Propeller Pitch*
- *LEFT: Decreases propeller RPM*
- *RIGHT: Increases propeller RPM*

**Propeller Governor
Circuit Breaker**

ENGINE CONTROLS

The P-47 has many different engine controls... but what do all these levers do exactly? Here is a table that sums up what engine parameter you can affect with specific engine controls.

ENGINE CONTROL VS ENGINE PARAMETER EFFECT	
Throttle	Controls manifold pressure / engine power.
Propeller RPM (P) Control Lever	Controls propeller RPM
Mixture Lever	Controls fuel/air mixture ratio, which allows diluted mixture with AUTO LEAN (used for long-range flights during cruise to save fuel) or rich mixture with AUTO RICH (used for better performance but increases fuel consumption). FULL RICH is only used for cases where the automatic control is defective.
Turbocharger (Boost) Control Lever	Controls turbocharger, which allows you to increase manifold pressure further when flying at high altitudes (above 12000 ft when air density drops significantly).
Water Injection Button	Water injection system (water-methanol mixture) cools down the mixture and does not increase engine power by itself, but it allows the engine to be run at a higher pressure setting without risking overheat.
Intercooler Shutter Switch	Affects carburetor air temperature.
Oil Cooler Shutter Switch	Affects oil temperature and pressure.
Engine Cowl Flaps Control Handle	Affects CHT (Cylinder Head Temperature).



ENGINE POWER SETTINGS

POWER SETTINGS TABLE (GRADE 100 FUEL)

Setting	Sea Level	25,000 ft	29,000 ft	33,000 ft	35,000 ft	Description
Takeoff	52" Hg 2700 RPM	-	-	-	-	<ul style="list-style-type: none"> Limited to 15 minutes Cowl Flaps FULLY OPEN Intercooler shutters NEUTRAL Oil cooler shutters NEUTRAL Mixture AUTO RICH
Climb	42" Hg 2550 RPM	42" Hg 2550 RPM	42" Hg 2550 RPM	36" Hg 2550 RPM	33" Hg 2550 RPM	<ul style="list-style-type: none"> Max Continuous Power (use for high-speed cruise) Best climb speed: 150-165 mph Cowl Flaps FULLY OPEN (increase airspeed if cylinder head temperature is above 230 deg C) Intercooler shutters OPEN during standard flight, NEUTRAL during cold weather (or flying at speeds above 350 mph), CLOSED if carburetor temperature drops below 25 deg C. Oil cooler shutters OPEN (unless operating in cold weather) Mixture AUTO RICH
Cruise	32" Hg 2250 RPM	32" Hg 2250 RPM	30" Hg 2250 RPM	28" Hg 2250 RPM	-	<ul style="list-style-type: none"> Used for normal operation Cowl Flaps FULLY CLOSED when flying above 225 kts, 1/3 OPEN when flying below 225 kts Intercooler shutters OPEN during standard flight, NEUTRAL during cold weather (or flying at speeds above 350 mph), CLOSED if carburetor temperature drops below 25 deg C. Oil cooler shutters OPEN (unless operating in cold weather) Mixture AUTO LEAN
Minimum Cruise	31" Hg 2150 RPM	31" Hg 2150 RPM	-	-	-	<ul style="list-style-type: none"> Used below 25,000 ft for fuel conservation. Cowl Flaps FULLY CLOSED when flying above 225 kts, 1/3 OPEN when flying below 225 kts Intercooler shutters OPEN during standard flight, NEUTRAL during cold weather (or flying at speeds above 350 mph), CLOSED if carburetor temperature drops below 25 deg C. Oil cooler shutters OPEN (unless operating in cold weather) Mixture AUTO LEAN

- Note 1:** During a dive, make sure to close your cowling flaps or you may overcool the engine.
- Note 2:** Cowl flaps are usually left 1/4 OPEN (or fully closed) when flying above 225 kts since they generate a lot of turbulence and drag at high speeds. If you run into a cylinder head temperature (CHT) overheat, you have to reduce throttle, slow down and only then open cowl flaps once you are below 225 kts (or the flaps could very well jam or be damaged).
- Note 3:** Carburetor icing can occur at any time when the temperature and dew point are within 12 deg C of each other. The P-47 does not have a carburetor heater, but when icing is detected (noticeable by a sudden loss of power, airspeed and a decrease in the carburetor air temperature), close intercooler shutters. If carburetor air temperature doesn't rise to above 12 deg C, push the Turbosupercharger (Boost) Control lever forward.
- Note 4:** In case of an engine oil overheat, reduce throttle and increase airspeed.

POWER BOOSTING

The Thunderbolt, despite its heavy weight, is a fighter that was meant to be flown at high altitudes. Why? Because of its engine. The P-47's great performance at high altitudes is explained by the fact that the plane has two types of "power boosting devices":

- a) A geared supercharger which is an integral part of the engine, and;
- b) A turbosupercharger (also called "turbo" or "turbocharger"), installed just forward of the tail section.



What's the difference between a turbo and a supercharger? Good question! Simply put:

- A **turbocharger** uses the **velocity and heat energy of the searingly hot (and expanding) exhaust gases** rushing out of an engine's cylinders to spin a turbine that drives a small compressor, or impeller, that in turn stuffs more air back into the engine.
- A **supercharger** also pumps additional air into the engine, but it is instead **driven mechanically by the engine** via a belt that runs off the crankshaft or by an electric motor.

Each of these power-boosting technologies has advantages and disadvantages, but the most obvious difference is a **slight delay in response to throttle input**. That's because the turbocharger requires a moment to "spool up" before delivering its burst of additional power—it takes a second for exhaust heat and pressure to increase enough to spin the turbo after you throttle up the Boost (B) lever. It's called "boost lag" or "turbo lag" for obvious reasons. By contrast, a supercharger has no lag; because its air pump is linked directly to the engine's crankshaft, it's always spinning and instantly responsive. The power boost it provides, and therefore the engine response you feel through the seat of your pants, increases immediately in direct proportion to how far you throttle up.

While the turbo's primary drawback is boost lag, the supercharger's is efficiency. Because a supercharger uses the engine's own power to spin itself, it siphons power—more and more of it as engine revs climb. Supercharged engines tend to be less fuel efficient for this reason. For developing mega power with instant kick-you-in-the-back throttle response, however, supercharging rules.

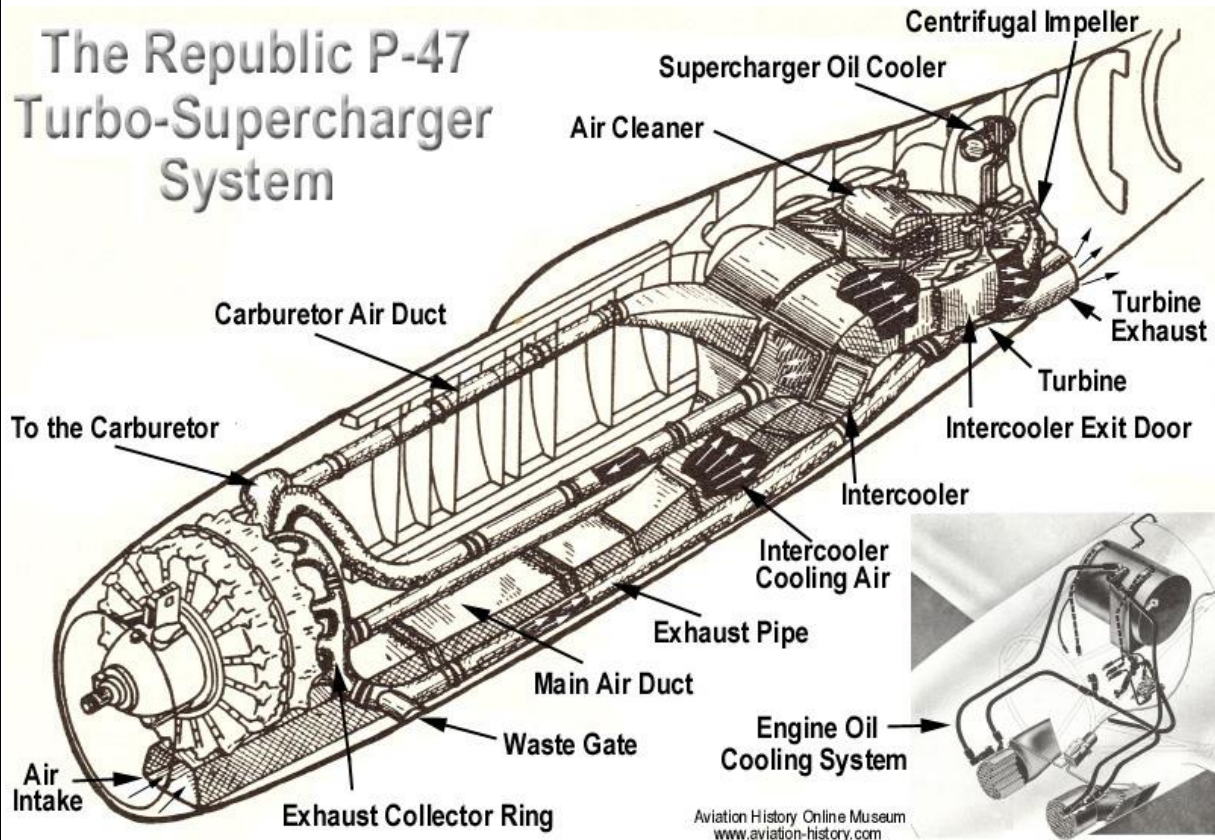

SUPERCHARGER BASICS

A **supercharger** is an engine-driven air pump or compressor that provides compressed air to the engine to provide additional pressure to the induction air so the engine can produce additional power. It increases manifold pressure and forces the fuel/air mixture into the cylinders. The higher the manifold pressure, the more dense the fuel/air mixture, and the more power an engine can produce. This system is used by many different WWII piston aircraft.

With a normally aspirated engine, it is not possible to have manifold pressure higher than the existing atmospheric pressure. A supercharger is capable of boosting manifold pressure above 30 "Hg. For example, at 8,000 feet a typical engine may be able to produce 75 percent of the power it could produce at mean sea level (MSL) because **the air is less dense at the higher altitude**. The supercharger compresses the air to a higher density allowing a supercharged engine to produce the same manifold pressure at higher altitudes as it could produce at sea level.

Thus, an engine at 8,000 feet MSL could still produce 25" Hg of manifold pressure whereas without a supercharger it could produce only 22 "Hg. Superchargers are especially valuable at high altitudes (such as 18,000 feet) where the air density is 50 percent that of sea level. The use of a supercharger in many cases will supply air to the engine at the same density it did at sea level. With a normally aspirated engine, it is not possible to have manifold pressure higher than the existing atmospheric pressure.

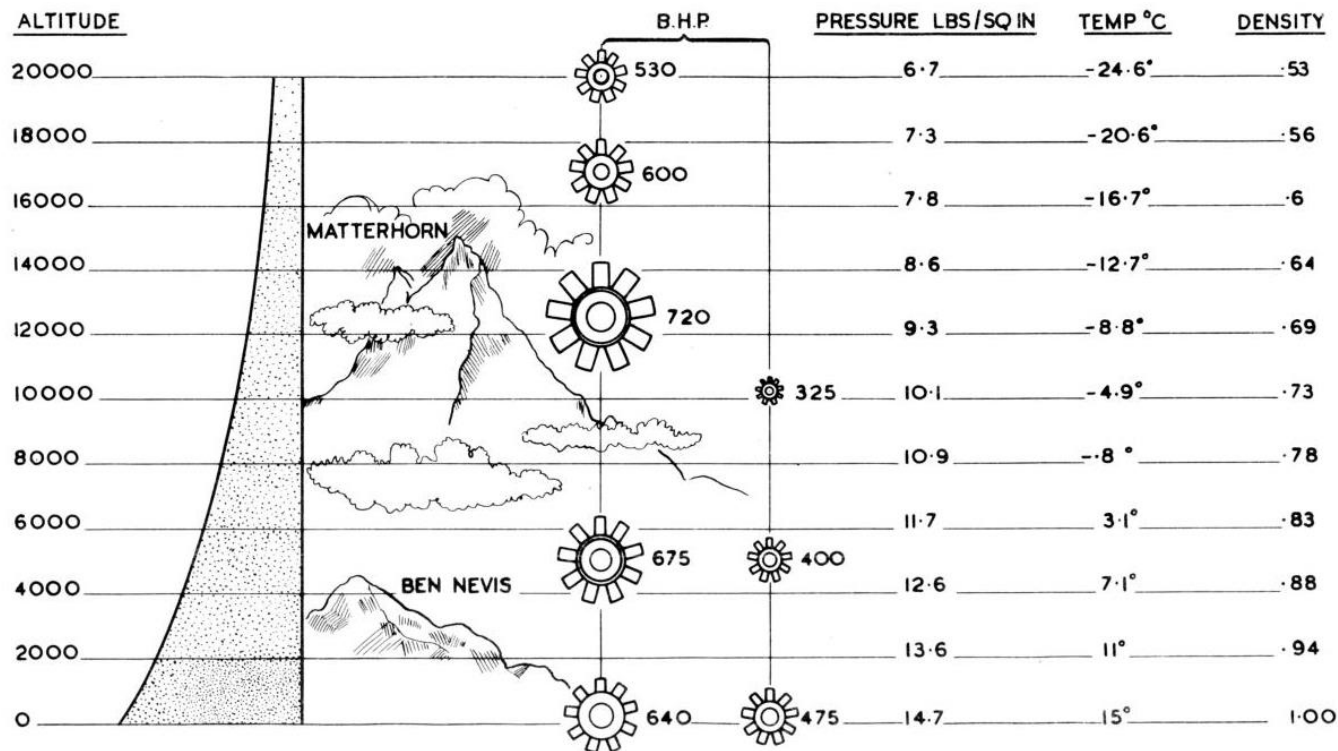
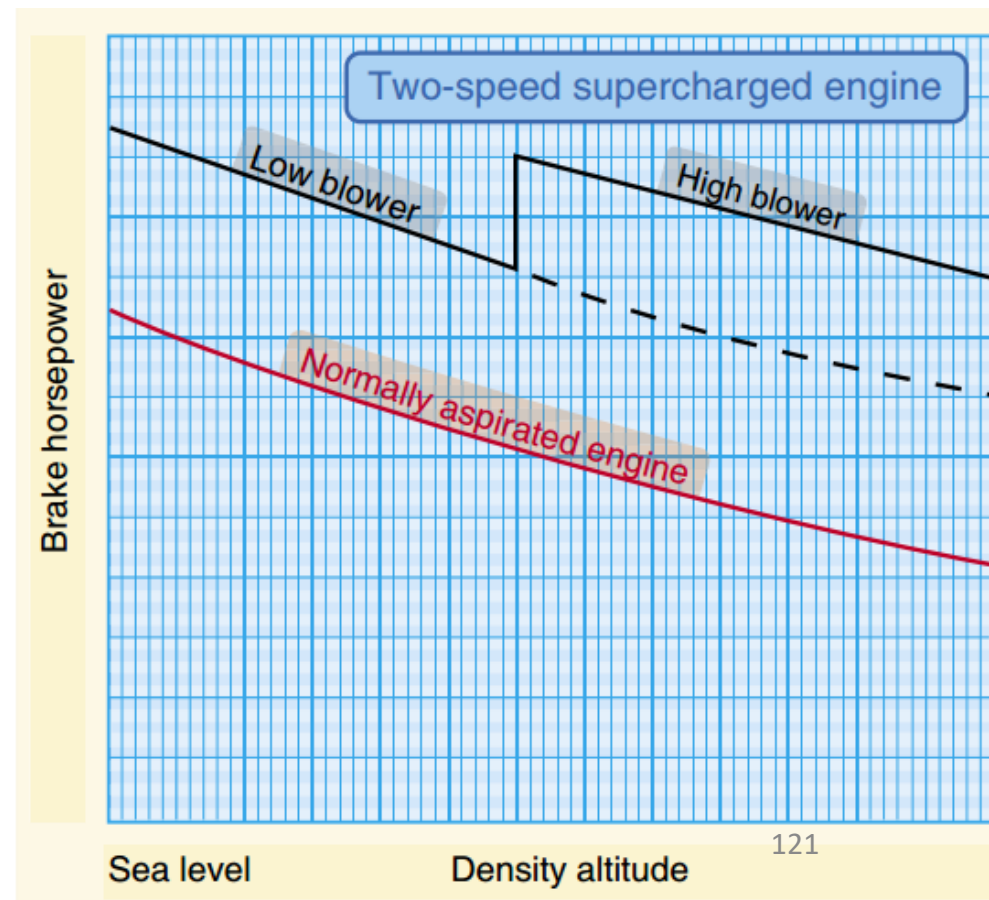

DIAGRAM SHOWING ATMOSPHERIC AND POWER VARIATIONS



TURBOSUPERCHARGER BASICS

The principle of operation of the turbocharger is as follows: the exhaust gases coming from the engine are directed to the gas turbine which drives the compressor, which in turn compresses the air. A side effect of such compression is the strong heating of the air. Therefore, the air is cooled down by an intercooler, which is installed in the tail section, before it enters the engine cylinders.

Cold air for blowing the intercooler is drawn from the air intake, which is placed under the engine. Then it passes through a long duct, and is supplied to the outer surfaces of the intercooler tubes to cool the compressed air, coming from the turbocharger to the carburetor, and then, it is released through two adjustable nozzles on the sides of the fuselage tail section.

Typically, a turbocharger is used at altitudes more than 12,000 feet, as well as for takeoff at very heavy weight configurations and emergency boost at any altitude.

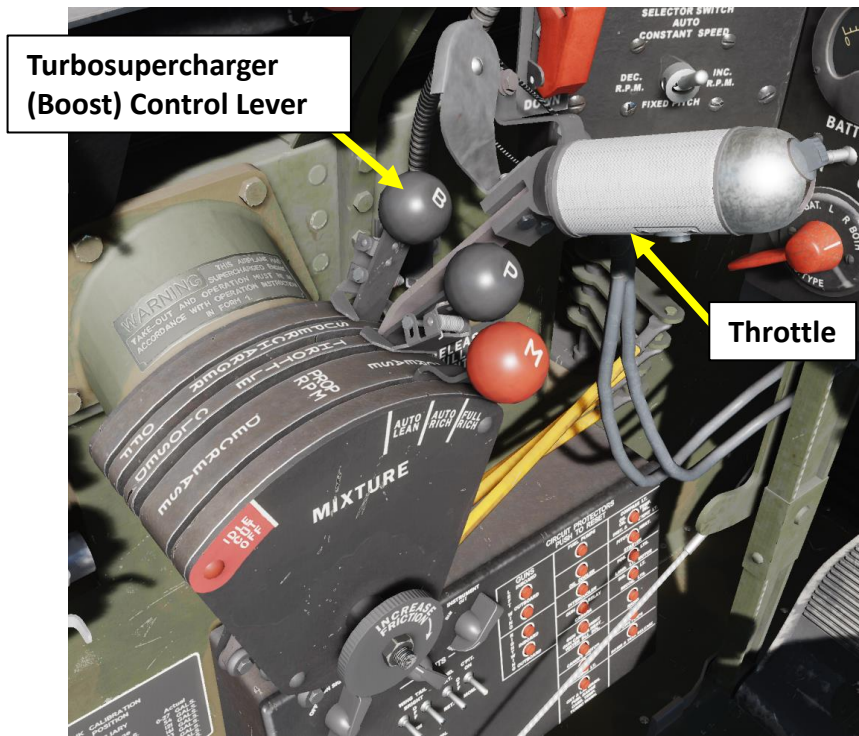

Turbocharger Tachometer (x1000 RPM)

Maximum allowable turbocharger RPM is 22,000



Turbine Overspeed Light

Illuminates when turbocharger RPM exceeds 22,000

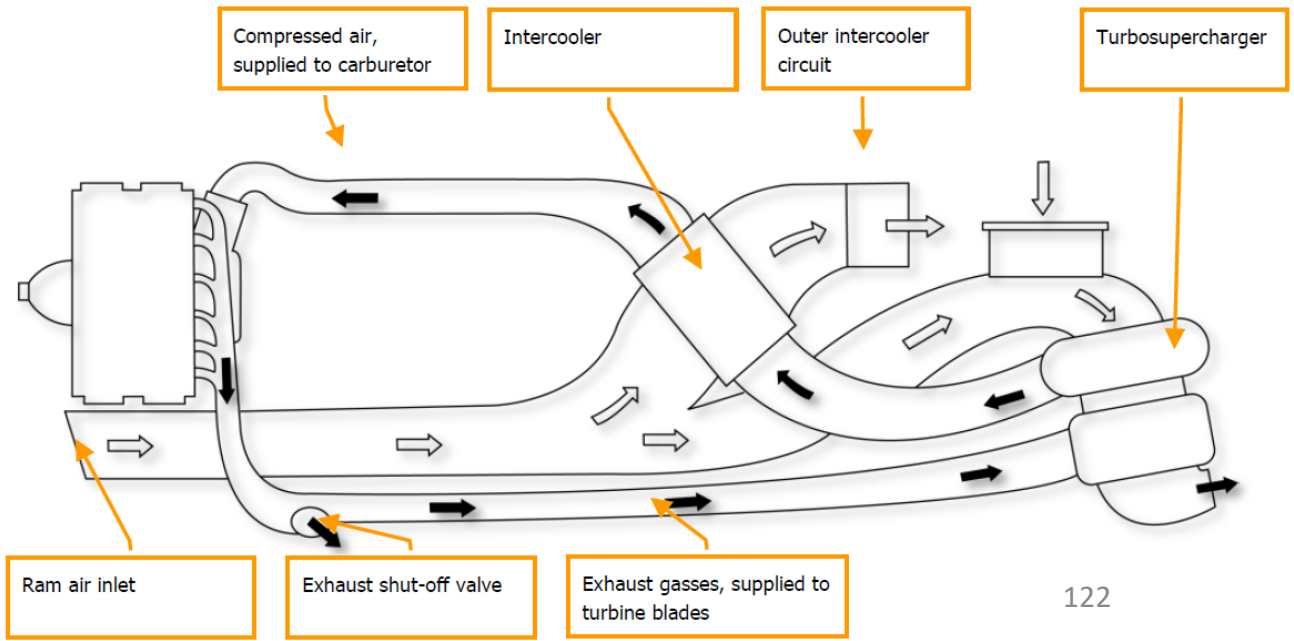
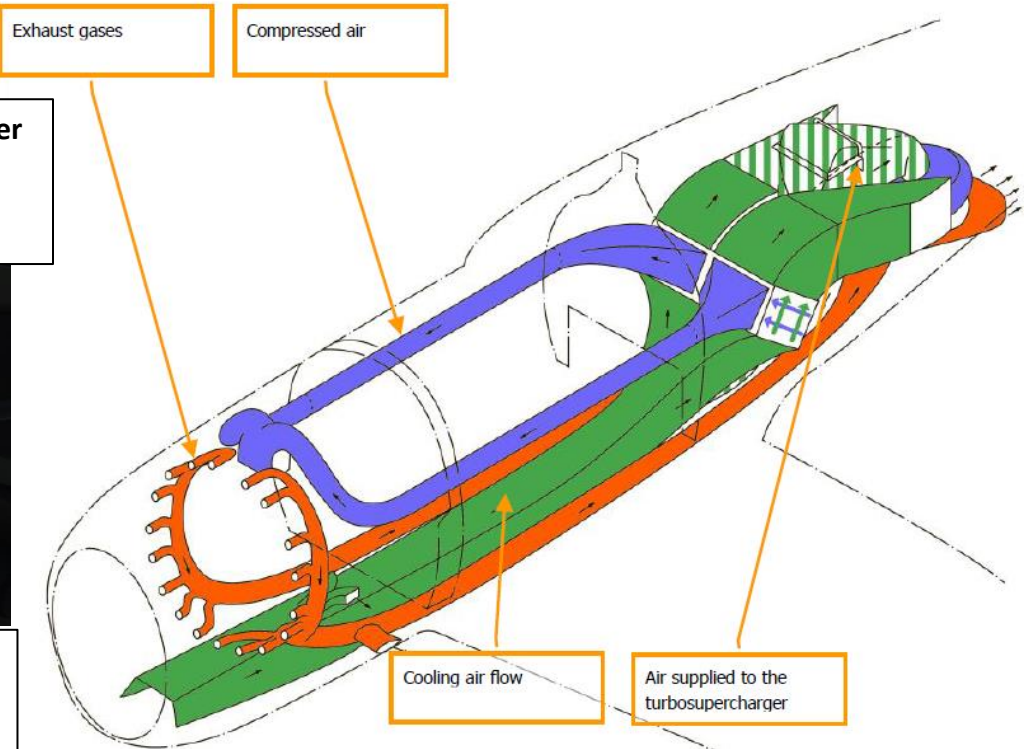

TURBOSUPERCHARGER OPERATION

- To use the turbosupercharger, you should be at an altitude of 7000 ft or above. Recommended altitude to use a turbosupercharger is above 12,000 ft.
- Verify that Throttle and Turbosupercharger Control Lever (B) are not interconnected.
- Set Turbosupercharger Control Lever (B) fully AFT (OFF).
 - Note: the Turbosupercharger lever must **NEVER** be advanced in front of the Throttle or you risk damaging the turbosupercharger.
- Push throttle forward to gain the maximum manifold pressure.
- Once throttle is fully forward, advance Turbosupercharger Control Lever (B) to engage turbo as desired.
- Turbo Tachometer RPM will increase, increasing Manifold pressure and engine power in the process.
- At high altitudes, you should not need to touch the throttle; engine power should be controlled with the (B) lever.
- The turbo RPM can be pushed to 22,000 RPM for 15 minutes maximum.
- If you want to disengage turbosupercharger or throttle down, set Turbosupercharger Control Lever (B) AFT first, then throttle back.

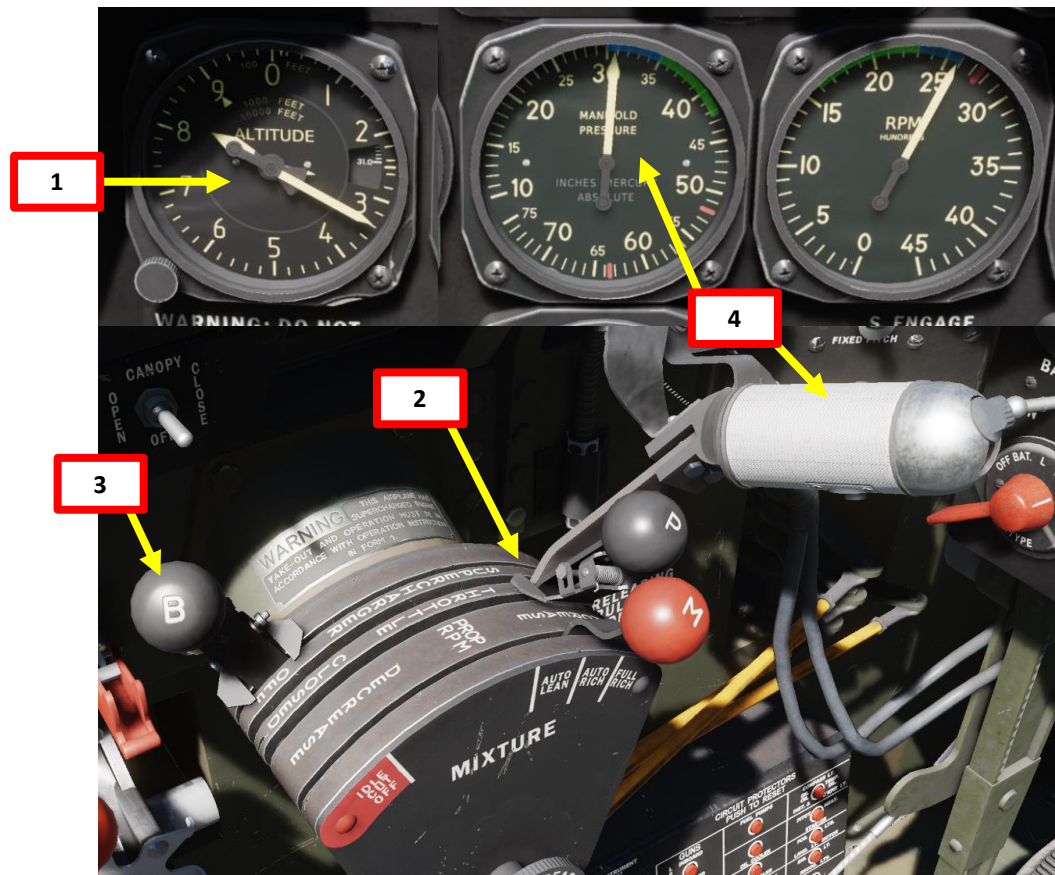

Turbosupercharger Tachometer (x1000 RPM)
 Maximum allowable turbocharger RPM is 22,000

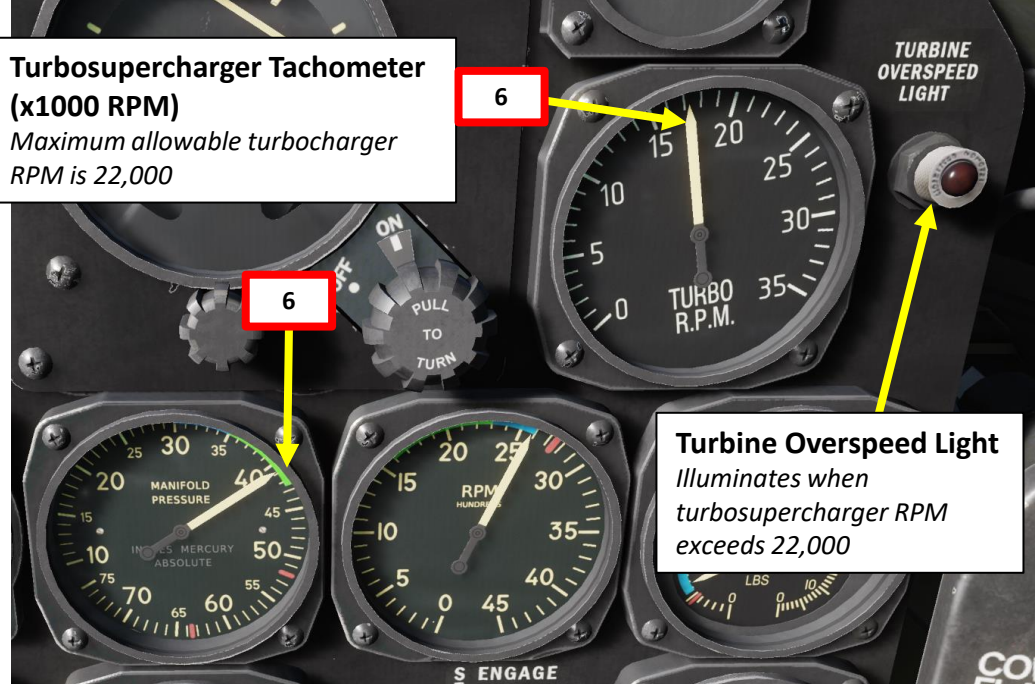

Turbine Overspeed Light
 Illuminates when turbosupercharger RPM exceeds 22,000

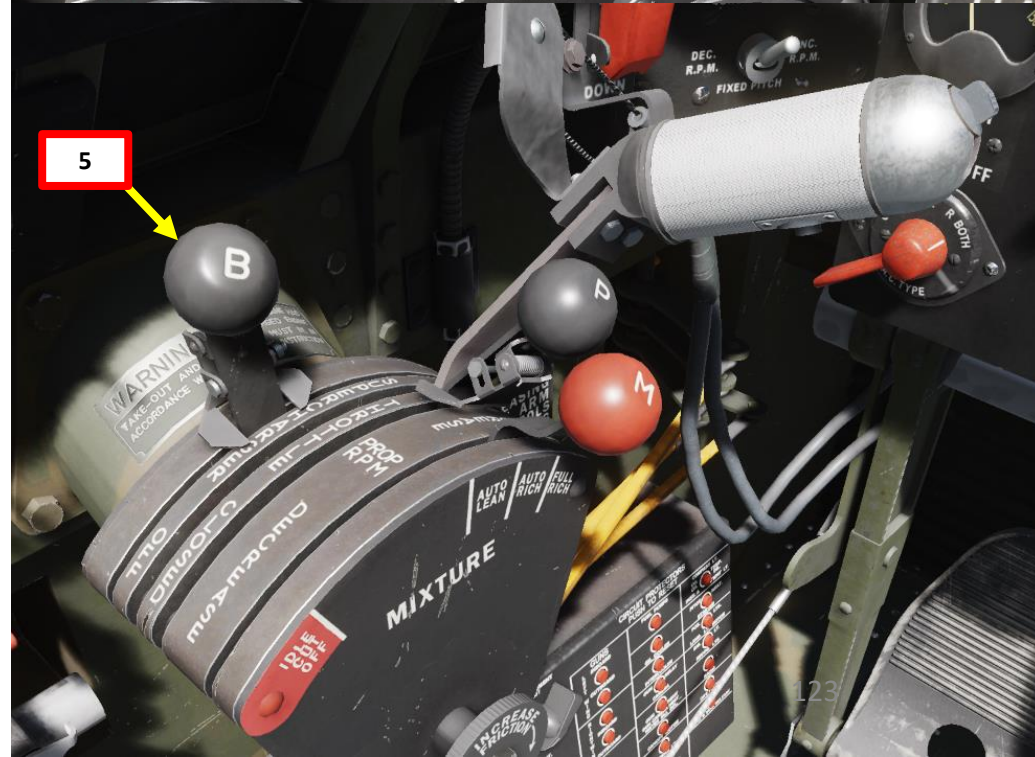

TURBOSUPERCHARGER RULES AND TIPS

Here are a number of general rules to consider when operating the turbosupercharger.

- Turbo should be used above 7000 ft.
- Turbosupercharger (Boost) Control lever should **NEVER** be advanced past the throttle. Doing so can create a pressure build-up and blow the seals in the air ducting. If that happens, you will not be able to build up pressure and will likely have to descend.
- Interconnecting the Boost lever and the throttle can be done to facilitate power management during dogfights; this is useful in cases when you need a quick response of power or if you are making a takeoff with water injection. However, interconnecting these levers has some drawbacks.
- Interconnecting the Boost lever is generally not recommended since the operation of the turbosupercharger's impeller costs the engine about 300 horsepower (due to mechanical energy being "lost" in the gear-driven shaft), which otherwise could be delivered to the propeller. This loss of horsepower is minimized at higher altitudes.
- My personal recommendation would be to interconnect Boost/Throttle in cases where you know you will be playing with power at medium altitude (10000-20000 ft). Otherwise, keep Boost/Throttle disconnected. The rationale behind this is that if you are at high altitude, there shouldn't be any reason for you to cut the throttle (you will simply fall out of the sky) since you can control power reasonably well with the Boost lever. If you are at low altitude, the induced loss in horsepower (as explained above) isn't worth using the turbosupercharger.

Here are a few interesting videos on the P-47's turbosupercharger:

- P-47 Thunderbolt Pt. 1A Throttle and Boost Lever Use: <https://youtu.be/HHtypRJuNKY>
- Turbo vs Supercharging in WW2 Airplanes: <https://youtu.be/ULLslo1VzTw>
- The Turbosupercharger: Master Of The Skies: <https://youtu.be/KFwwgbj9Bi8>

Right Click on Interconnect Latch to connect Throttle and Turbosupercharger (B) levers
 Left Click on Interconnect Latch to disconnect Throttle and Turbosupercharger (B) levers

Turbosupercharger
(Boost) Control Lever

Throttle

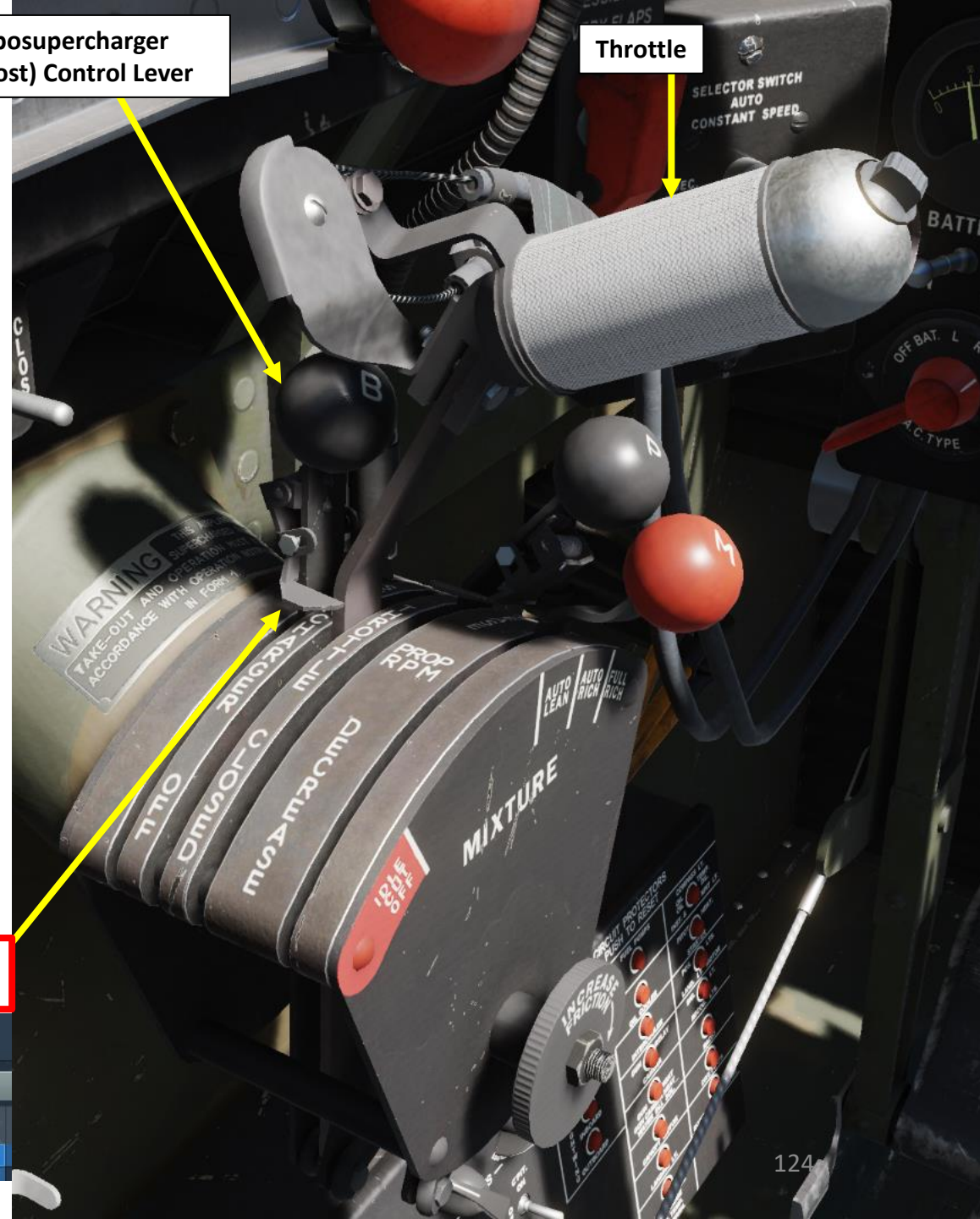

CONTROL OPTIONS

Action	Category	Keyboard	Throttle - HOTAS...
Interconnect Boost Lever to Throttle (toggle)	Engine Controls	RCtrl + RWin + M	JOY_BTN15
Interconnect Boost Lever to Throttle EBFE	Engine Controls		

WAR EMERGENCY POWER (WEP) AND WATER INJECTION

The P-47 has a tank holding a solution of water and methanol to prevent detonation while drawing War Emergency Power (WEP).

The mixture is injected finely into the inlet manifold and then entrained into the cylinders. The presence of the water reduces the temperature of the mixture, which makes it possible to increase the supercharging and increase the efficiency of the engine and get more power without causing detonations.

Water injection system consists of a 30-gallon consumable water tank, an engine driven pump, water pressure regulator, a relief valve and automatic boost-reset.

Water injection is controlled by a switch, which is located on the throttle. The switch opens a solenoid valve that transmits a mixture of water and methanol to the regulator. At the same time, the automatic boost mechanism is triggered under water pressure in the supply line and the mixture is impoverished to reduce fuel consumption. The water injection system is heated in flight by the engine heat, which prevents the system from freezing in flight.

Water injection occurs when the engine is running in War Emergency Power (WEP) mode, which is activated by **pressing the Water Injection button on the throttle** and then **throttling up to approximately 1/8 inch from the full forward throttle position (95 %)**. The pressure in the collector reaches then up to 64 inches of Hg, increasing power by 30%. The water supply is **sufficient for about 15 minutes of operation**.

Water Pressure Gauge (psi)

Indicates current pressure in the water-methanol mixture injection system. Green indicates operational range.



Engine Manifold Pressure Indicator (inches Hg)

Blue: Cruise Range
 Green: Operational Range



War Emergency Power Manifold Pressure

Water Injection (Water-Methanol Mixture) Button

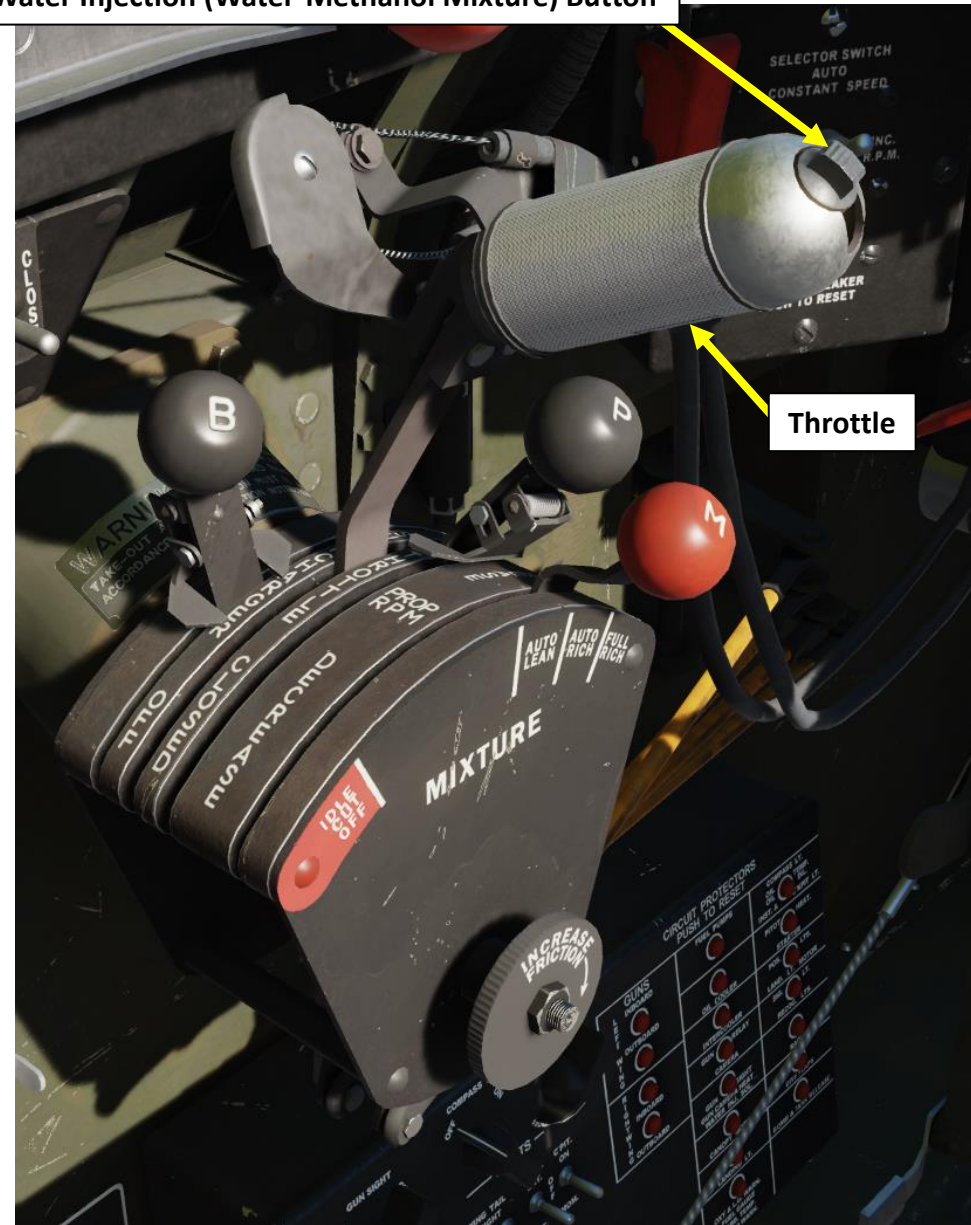

FUEL TANKS

Fuel Capacity
Main Tank Capacity: 270 gal
Auxiliary Tank Capacity: 100 gal
Total Capacity: 370 gal

Main Fuel Tank Quantity Indicator (US gal)

Auxiliary Fuel Tank Quantity Indicator (US gal)



Fuel Level Warning Light
Illuminates when fuel quantity in main tank is less than 40 US gallons

Auxiliary Fuel Tank

Main Fuel Tank

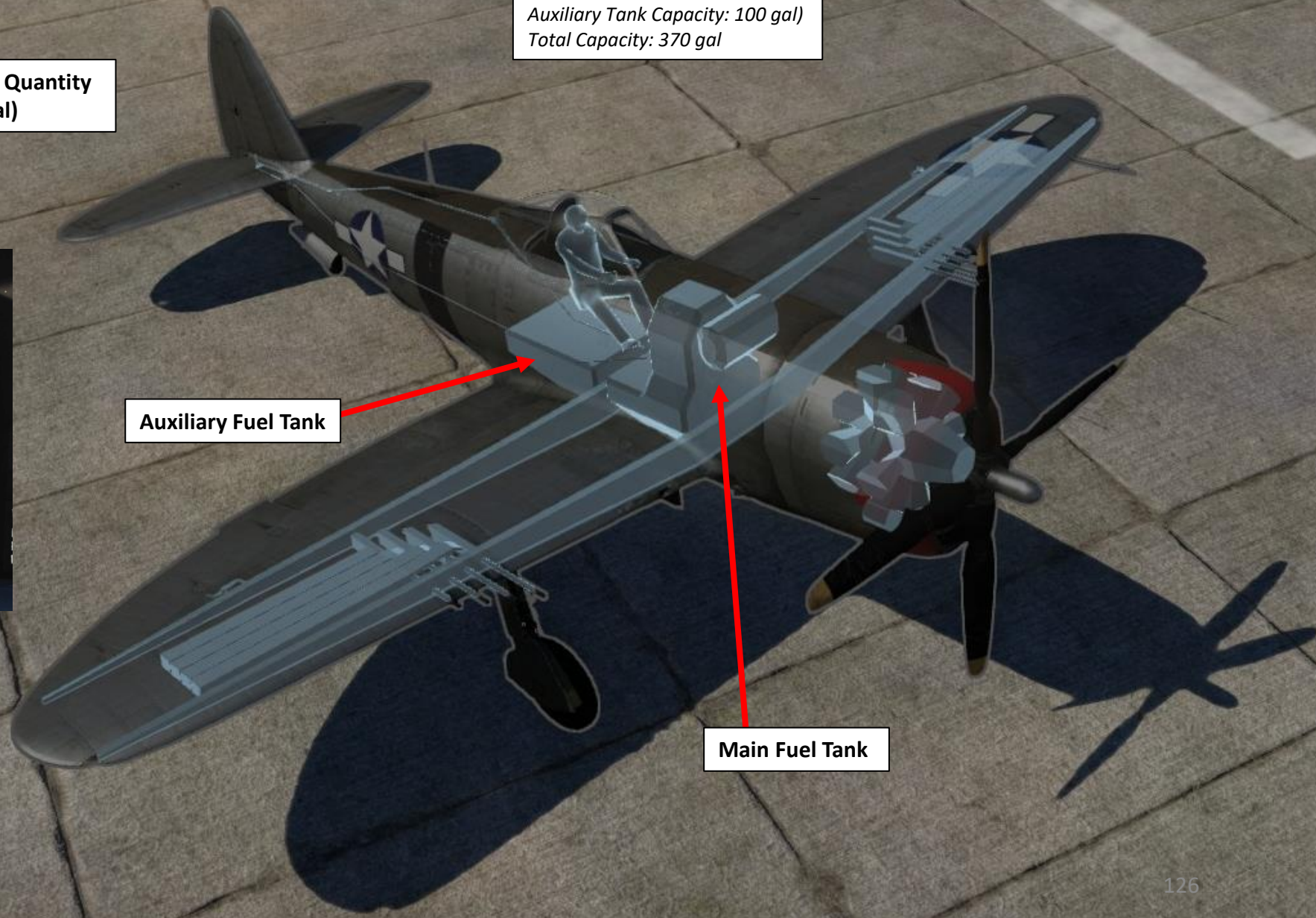

FUEL TANKS

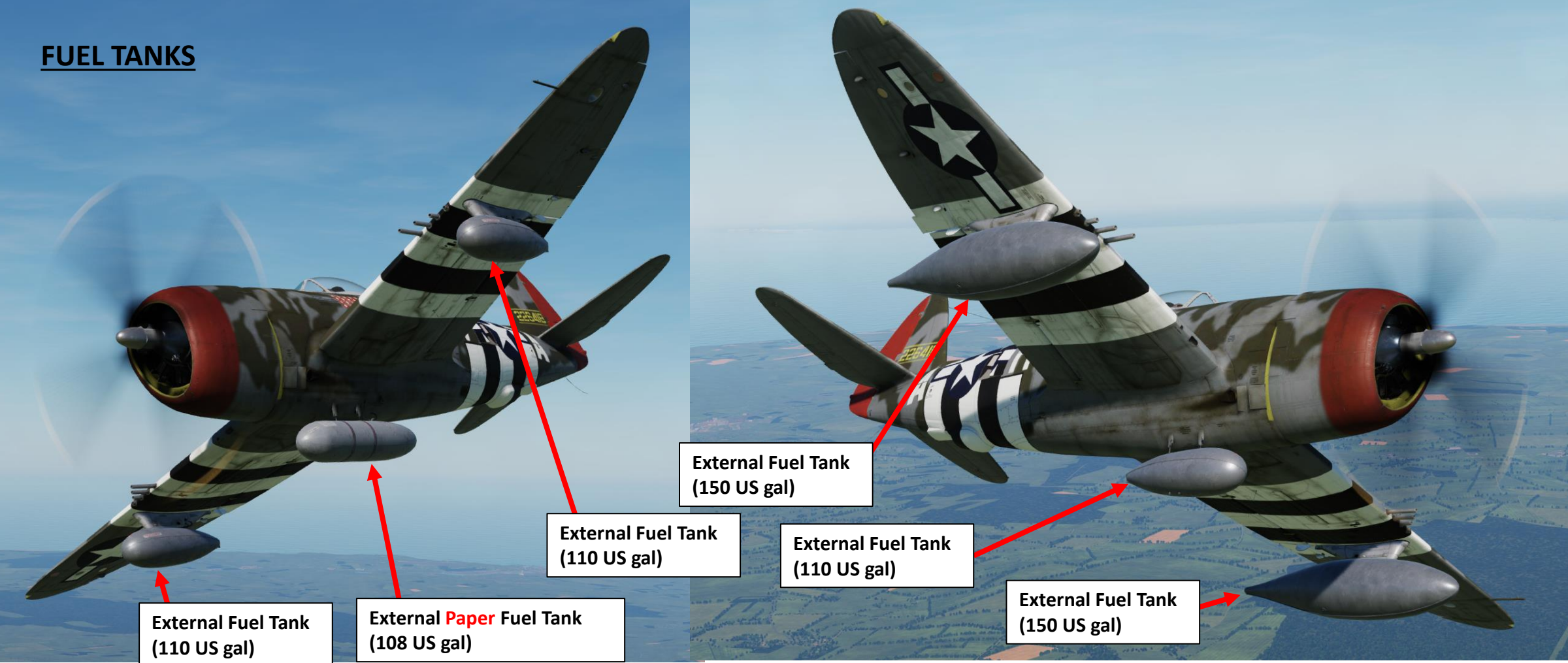

Fun Fact:

Faced by wartime metal shortages and a need to extend the range of fighter craft, the British came up with drop tanks made of glue-impregnated kraft paper, which had excellent tolerance characteristics for extreme heat and cold necessary for operation on an aircraft as well as being waterproof. Since the glue would slowly dissolve from the solvent effects of the fuel (sometimes developing leaks within a few hours of being loaded with fuel) these were strictly a single-use item, used in typically chilly Northern European conditions, filled immediately before take off, jettisoned in the event of an aborted mission and only being required for the outbound portion of any flight. Such papier-mâché tanks were assembled from three main components, the nose cone, tail cone and the body, each shaped over wooden forms, the centre section created by wrapping layers of the impregnated paper around a cylinder, the end caps hand-laminated with petal-shaped pieces sometimes named gores. Some 13,000 papier-mâché tanks were made and used by the RAF, the vast majority used in the course of the war, conserving a considerable amount of metal. Very few examples survive due to their expendable nature and low intrinsic value at the time of their creation, and the fact that they are not inherently robust.

FUEL MANAGEMENT

The P-47 fuel gauge only displays fuel quantity for the main and auxiliary fuel tank. The external fuel tanks have no fuel quantity indication. Here are a few pointers on how to manage your fuel during flight.

- During takeoff and landing, set Fuel Selector Valve Handle to MAIN (FWD)
- After takeoff, if fuel is available in the Auxiliary Tank, set Fuel Selector Valve Handle to AUXILIARY (RIGHT). **You need to empty the auxiliary tank first** since it shifts your center of gravity aft and gives the aircraft undesirable aerodynamic characteristics. If auxiliary tank is empty, use Main Fuel Tank.
- When the fuel pressure drops or the engine runs exceedingly rough, coughs or emits black smoke, this means that your selected fuel tank is empty.
- To use external fuel drop tanks, set the External Fuel Tank Selector Valve Handle to your desired tank first, then set Fuel Selector Valve Handle to EXTERNAL (LEFT).

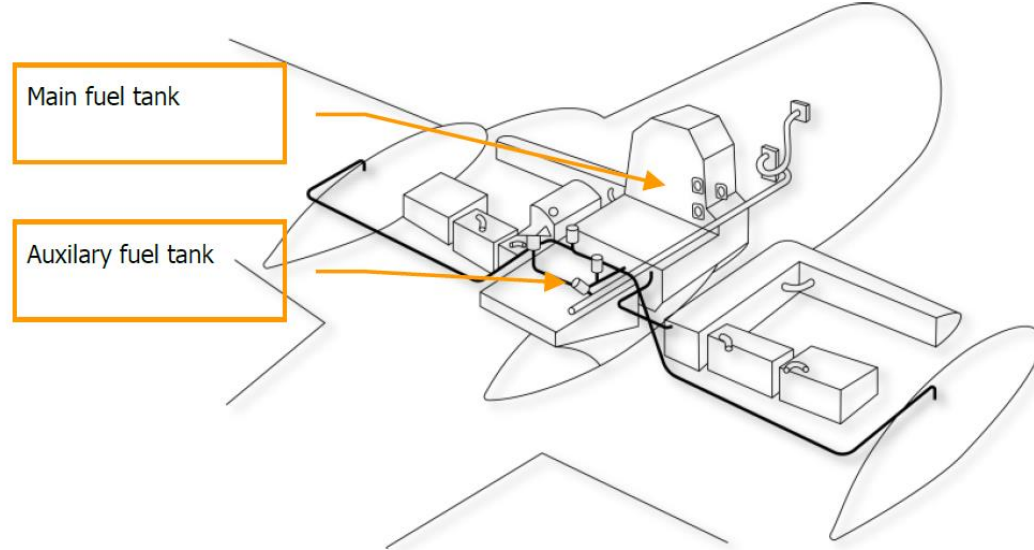

Engine Fuel Pressure Indicator (psi)
Blue: Operational Range



External Fuel Tank Selector Valve Handle
This valve controls fuel flow from three external fuel tanks. Short shoulder of the handle selects the tank,

- LEFT TANK (AFT LEFT): Fuel supply taken from left wing external tank.
- RIGHT TANK (AFT RIGHT): Fuel supply taken from right wing external tank.
- BELLY (FWD LEFT): Fuel supply taken from external belly (fuselage) tank.
- OFF (FWD RIGHT): Cut-off of fuel supply from external tanks

Fuel Selector Valve Handle

Selects the fuel tank from which fuel will be fed into the engine. Short shoulder of the handle selects the tank,

- MAIN (FWD): Main tank
- AUXILIARY (RIGHT): Auxiliary Tank
- EXTERNAL (LEFT): External Tank
- OFF (AFT): Cut-off of fuel supply and disables all fuel pumps

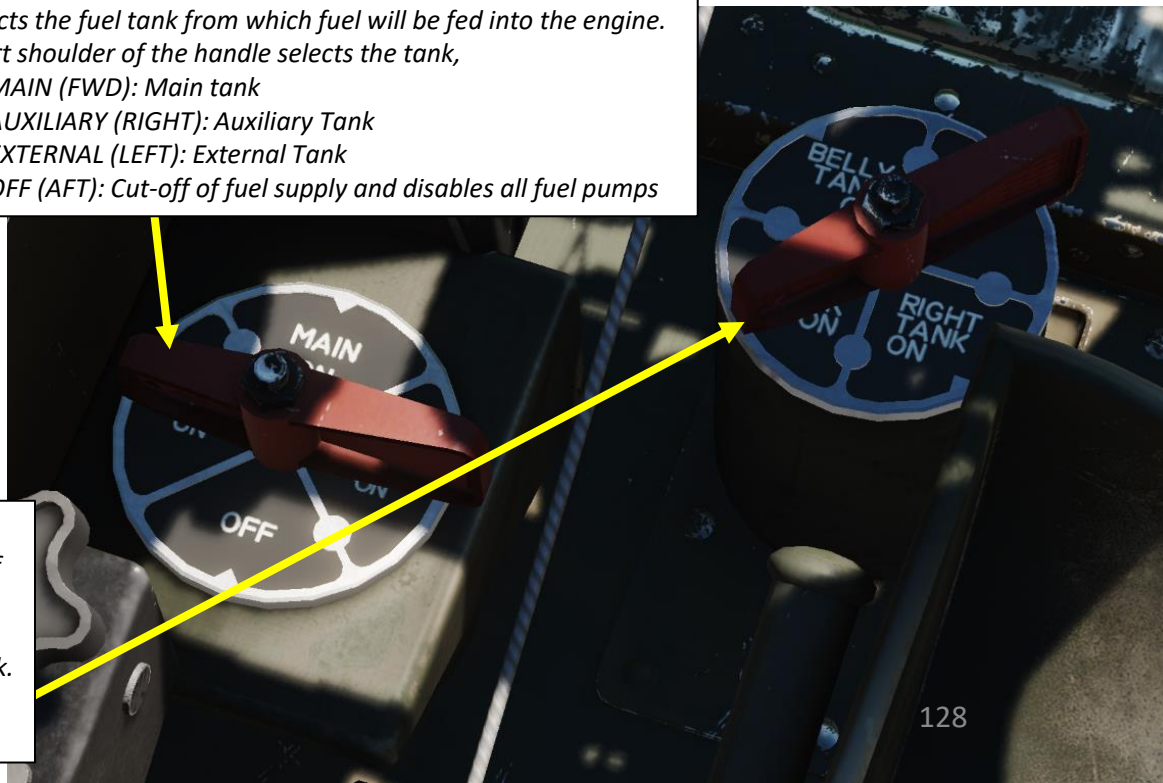

EXTERNAL FUEL DROP TANK OPERATION

To use fuel from external tanks:

1. Set External Fuel Tank Selector Valve Handle to desired tank (BELLY, RIGHT or LEFT EXTERNAL TANK)
2. Set Fuel Selector Valve Handle to EXTERNAL (LEFT) to use fuel from selected external tank.

Note: There is no fuel quantity indication for external tanks. You will know the tank is empty once the engine starts running rough.

Fuel Selector Valve Handle

Selects the fuel tank from which fuel will be fed into the engine. Short shoulder of the handle selects the tank,

- MAIN (FWD): Main tank
- AUXILIARY (RIGHT): Auxiliary Tank
- EXTERNAL (LEFT): External Tank
- OFF (AFT): Cut-off of fuel supply and disables all fuel pumps

2



External Fuel Tank Selector Valve Handle

This valve controls fuel flow from three external fuel tanks. Short shoulder of the handle selects the tank,

- LEFT TANK (AFT LEFT): Fuel supply taken from left wing external tank.
- RIGHT TANK (AFT RIGHT): Fuel supply taken from right wing external tank.
- BELLY (FWD LEFT): Fuel supply taken from external belly (fuselage) tank.
- OFF (FWD RIGHT): Cut-off of fuel supply from external tanks

1



EXTERNAL FUEL DROP TANK JETTISON

(P-47D-30 EARLY SERIES)

To jettison external tanks:

1. Set the Fuel Selector Valve Handle to MAIN
2. Pull the required Jettison Handle.

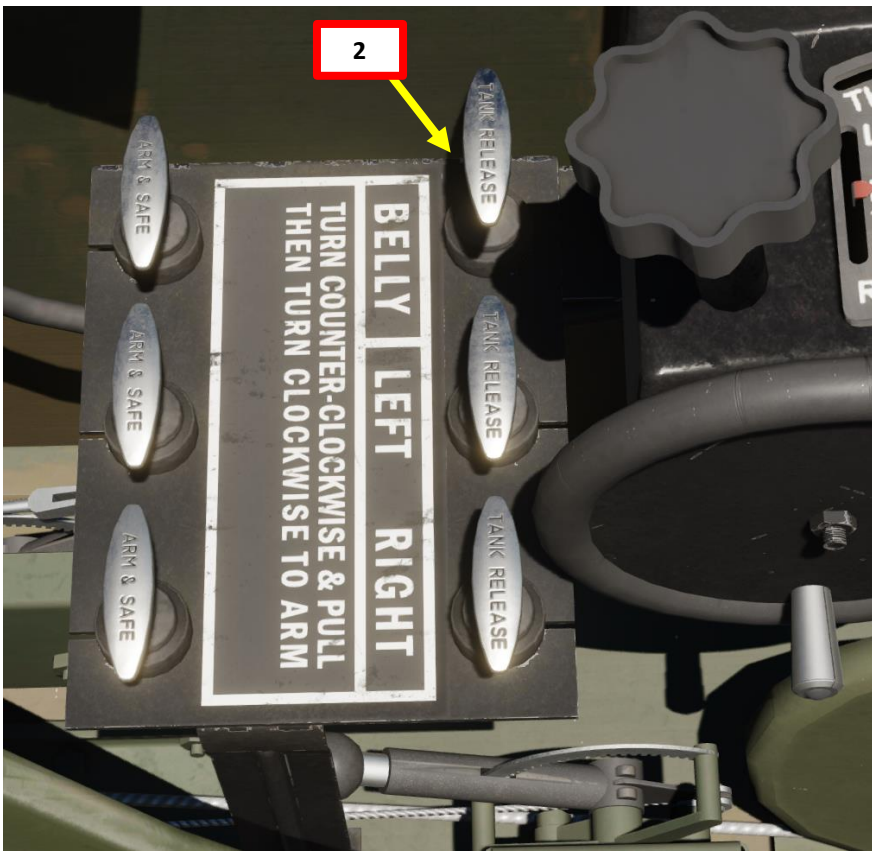

EXTERNAL FUEL DROP TANK JETTISON

(P-47D-30 LATE SERIES)

To jettison external tanks:

1. Set the Fuel Selector Valve Handle to MAIN
2. Pull the required Hardpoint Jettison Handle.

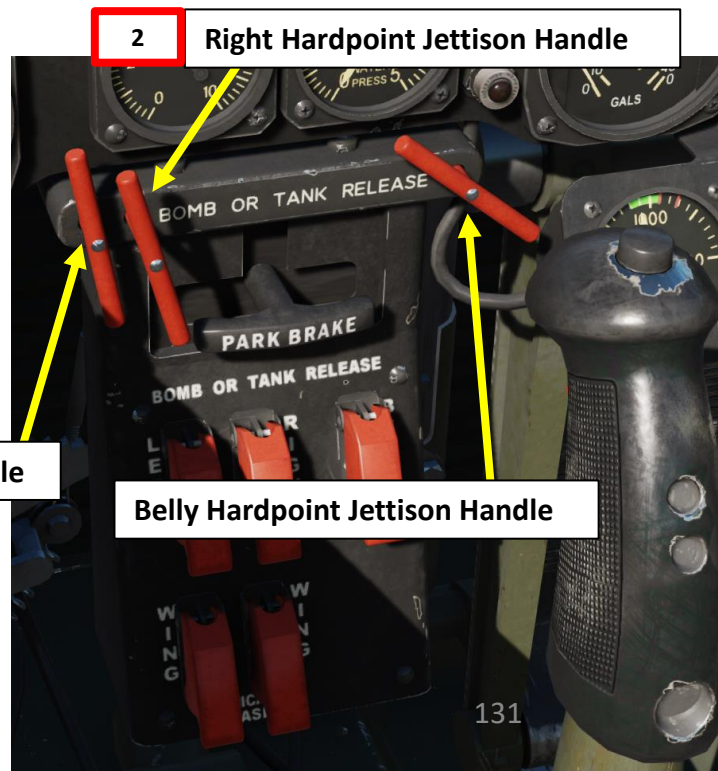

Left Hardpoint Jettison Handle

2 Right Hardpoint Jettison Handle

Belly Hardpoint Jettison Handle

EXTERNAL FUEL DROP TANK JETTISON

(P-47D-40 SERIES)

To jettison external tanks:

METHOD 1:

1. Set the Fuel Selector Valve Handle to MAIN
2. Pull the required Hardpoint Jettison Handle.

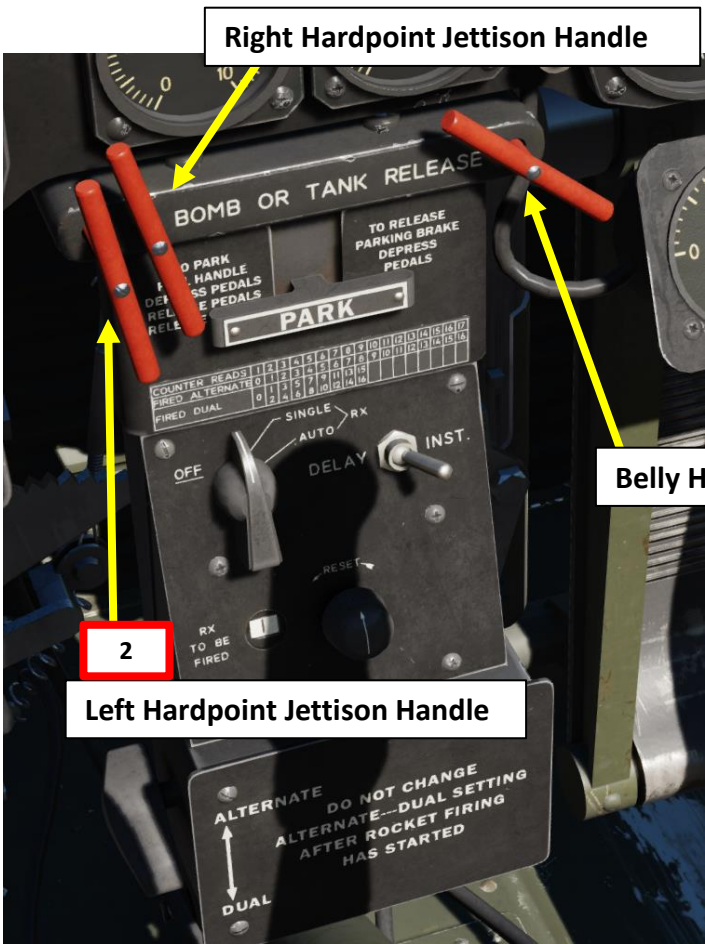

Belly Hardpoint Jettison Handle



EXTERNAL FUEL DROP TANK JETTISON

(P-47D-40 SERIES)

To jettison external tanks:

METHOD 2:

This method might be useful in situations where you need to jettison multiple tanks at once.

1. Set the Fuel Selector Valve Handle to MAIN
2. Set Rockets / Bomb & Tank Selector Switch to BOMB & TANK (UP)
3. Set Arming Selector Switches to ARMED (UP) for the fuel tanks you want to jettison (Left Wing, Right Wing or Belly Tank)
4. Flip red safety guard, then set Bomb/Tank/Rocket Safety Switch to ARMED (UP)
5. Press the Weapons (Bomb) Release Button (RSHIFT+SPACE) to jettison the selected external tanks

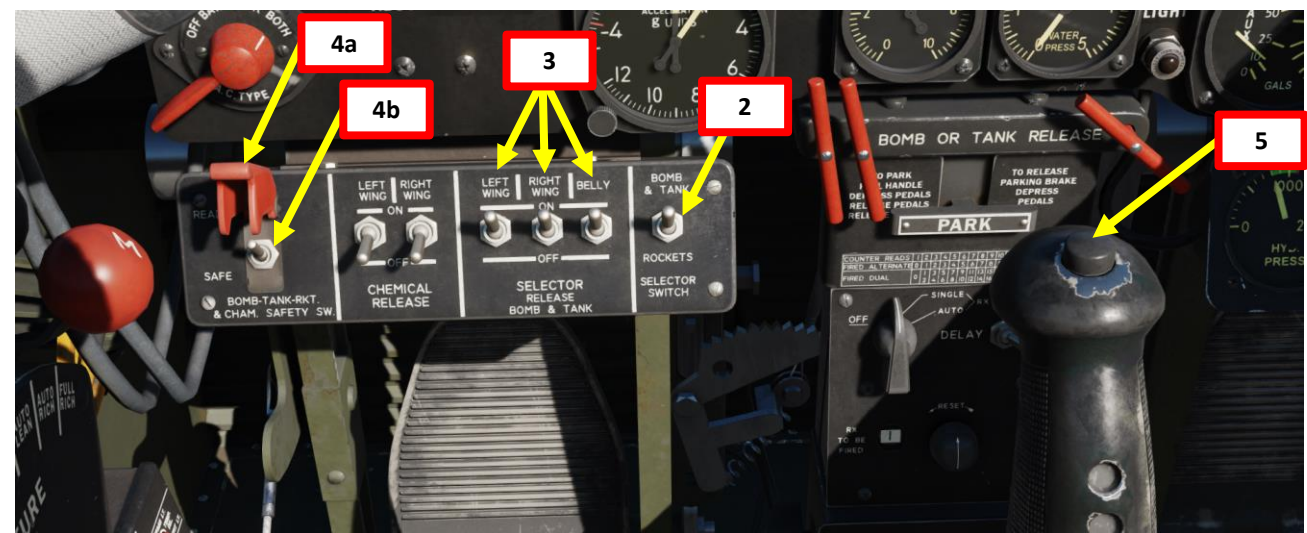

AIRCRAFT SPECIFICATIONS

Modification	P-47D-30-RE
Wing span, m.	12.42
Length, m.	10.99
Height, m.	4.44
Wing area, m²	27.87
Weight, kg.	
Empty plane	4853
Normal Takeoff	6622
Maximum Takeoff	7938
Engine type	Pratt & Whitney R-2800-59W Double Wasp
Power, h.p.	
Takeoff	1 x 2000
Short-term maximum	1 x 2430
Maximum speed, km. /h.	690
Cruising speed, km. /h.	563
Maximum range, km	
Without external tanks	1529
With external tanks	2898
Maximum climbing speed, m./min.	847
Maximum ceiling, m.	12192
Crew memb.	1
Weapons	Eight 0.50-inch Colt Browning M2 guns. 1135 kg of bombs, napalm tanks or unguided rockets

SPEED LIMITATIONS

- Do not extend landing gear and landing light at speeds above 200 mph
- Do not extend flaps at speeds above 190 mph
- Do not make turns below 130 mph (very important when flying in the pattern)
- Max permissible airspeed (indicated): 505 mph
- When external tanks are installed:
 - If using 75 US gal belly tank, do not exceed 350 mph
 - If using 110 US gal belly tank, do not exceed 325 mph
 - If using 165 US gal wing tank, do not exceed 300 mph

PROHIBITED MANEUVERS

- Intentional spins of more than one-half turn
- Outside loops
- Whip stalls
- Prolonged inverted flight (engine may cut out due to fuel starvation)
- Snap rolls
- Slow rolls above 313 mph
- Slow speed turns
- When external tanks are installed:
 - Dynamic Maneuvers
 - Training Landings
 - High-speed Dives
- Tight turns or dives exceeding 225 mph with cowl flaps open (tail buffeting may result)

STALLS

- Stall speed with flaps and landing gear UP: 115 mph IAS
- Stall speed with flaps and landing gear down: 100 mph IAS
- There is a pronounced tendency for the airplane to snap to the left when stalled in a turn. There is ample warning of the impending stall (sloppiness of the controls and buffeting).

**Maximum Permissible
Airspeed: 505 mph Indicated**



SPINS

- During all types of maneuvers and spin demonstrations, it has been found that the airplane will never spin of its own accord, but must be forced into the spin by use of elevator and rudder. To induce a spin, you must use full rudder and full elevator.
- To recover from a spin:
 - Set full rudder in the opposite direction to the spin
 - Set elevator to neutral position
 - Set full ailerons against the spin direction
 - Note: do not try different control position until at least three turns have been made with no change in the spinning attitude. Approximately 1000 ft of altitude will be lost in the entry into the spin, 1000 ft in the recovery and 1000 ft per turn.

SPIN RECOVERIES

NORMAL SPIN
Full opposite rudder
Slight back pressure on stick
Aileron against spin
Throttle if needed

FLAT SPIN
Opposite rudder
Throttle
Aileron in direction of spin

FLAT INVERTED SPIN
Apply hard aileron pressure in direction you appear to be turning
Slight back pressure on stick

PLACARDS

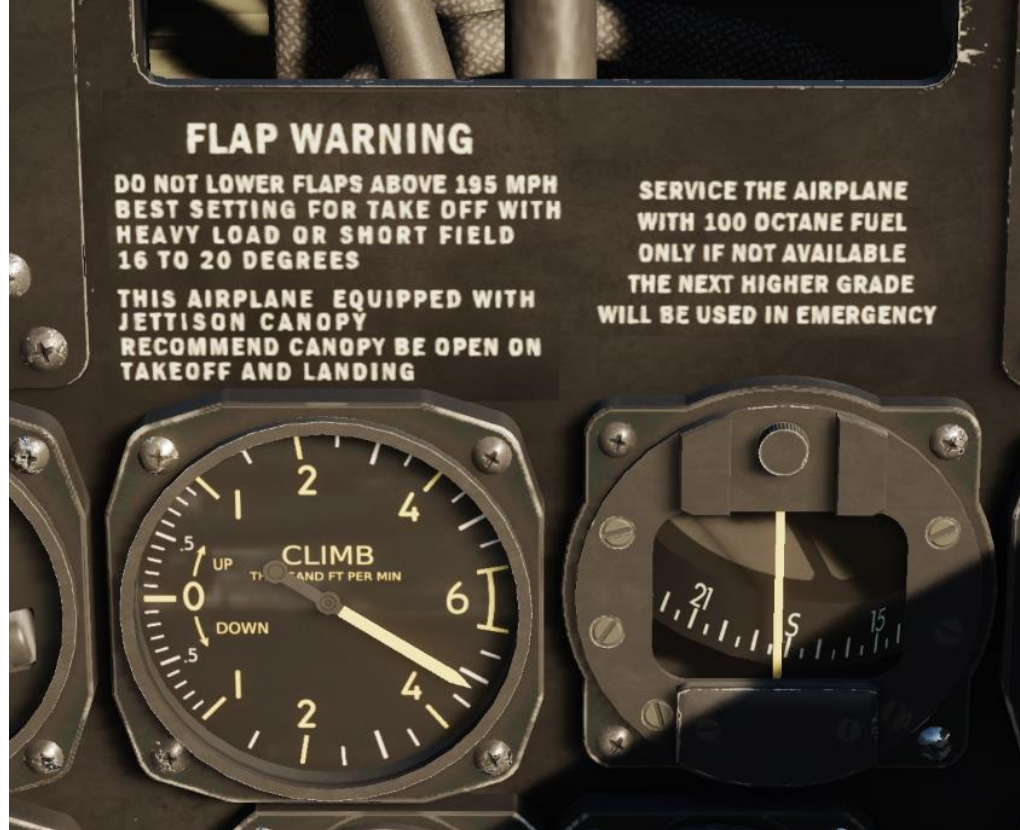

FUEL TANK CALIBRATION GROUND POSITION

AUXILIARY		MAIN	
Gage	Actual	Gage	Actual
10 GALS.	25 GALS.	0 GALS.	0-27 GALS.
25 GALS.	47 GALS.	40 GALS.	54 GALS.
50 GALS.	75 GALS.	100 GALS.	121 GALS.
75 GALS.	91 GALS.	150 GALS.	161 GALS.
F	100 GALS.	200 GALS.	203 GALS.
		225 GALS.	228 GALS.
		250 GALS.	253 GALS.
		260 GALS.	263-272 GALS.

92F45274-1

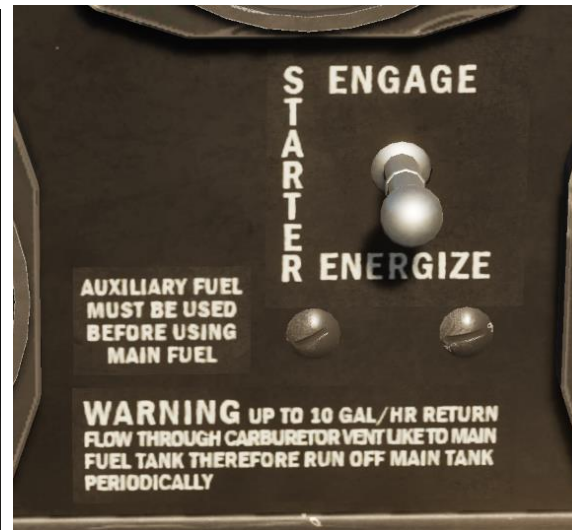

TAKEOFF, CLIMB & LANDING PERFORMANCE

AIRPLANE MODELS P-47 SERIES										ENGINE MODELS R-2800-21									
TAKE-OFF, CLIMB & LANDING CHART																			
TAKE-OFF DISTANCE (IN FEET)																			
GROSS WEIGHT (IN LBS.)	HEAD WIND (MPH)	HARD SURFACE RUNWAY						SOD-TURF RUNWAY						SOFT SURFACE RUNWAY					
		AT SEA LEVEL		AT 3,000 FT.		AT 6,000 FT.		AT SEA LEVEL		AT 3,000 FT.		AT 6,000 FT.		AT SEA LEVEL		AT 3,000 FT.		AT 6,000 FT.	
		GROUND RUN	TO CLEAR 30' OBJ.	GROUND RUN	TO CLEAR 30' OBJ.	GROUND RUN	TO CLEAR 30' OBJ.	GROUND RUN	TO CLEAR 30' OBJ.	GROUND RUN	TO CLEAR 30' OBJ.	GROUND RUN	TO CLEAR 30' OBJ.	GROUND RUN	TO CLEAR 30' OBJ.	GROUND RUN	TO CLEAR 30' OBJ.	GROUND RUN	TO CLEAR 30' OBJ.
15,000	0	2400	3500	2600	3800	2900	4200	2500	3600	2800	4000	3000	4300	2800	3900	3000	4200	3300	4600
	20	1800	2600	2000	3000	2200	3300	1900	2700	2100	3100	2300	3400	2100	2900	2300	3300	2500	3600
	40	1200	1800	1400	2000	1600	2300	1300	1900	1500	1700	1700	2400	1400	2000	1600	2200	1800	2500
14,000	0	2100	3100	2300	3400	2500	3800	2200	3200	2400	3500	2600	3900	2400	3400	2600	3700	2900	4200
	20	1500	2200	1700	2600	1900	2900	1600	2300	1800	2700	2000	3000	1800	2500	2000	2900	2200	3200
	40	1000	1500	1200	1800	1400	2100	1100	1600	1300	1900	1500	2200	1200	1700	1400	2000	1600	2300
12,500	0	1800	2800	2000	3100	2200	3400	1900	2900	2100	3200	2300	3500	2100	3100	2300	3400	2500	3700
	20	1300	2000	1500	2300	1600	2500	1400	2100	1600	2400	1700	2600	1600	2300	1700	2500	1900	2800
	40	900	1400	1000	1500	1200	1800	1000	1500	1100	1600	1300	1900	1100	1600	1200	1700	1400	2000

NOTE: INCREASE DISTANCE 10% FOR EACH 10°C ABOVE 0°C

ENGINE LIMITS FOR TAKE-OFF 2700 RPM & 52 IN. HG

CLIMB DATA																						
GROSS WEIGHT (IN LBS.)	TYPE OF CLIMB	COMBAT MISSIONS USE * 2700 RPM & 52 IN. HG								FERRY MISSIONS USE 2350 RPM & 35 IN. HG												
		S.L. TO 8000 FT. ALT.				AT 10,000 FT. ALT.				AT 15,000 FT. ALT.				AT 20,000 FT. ALT.				AT 25,000 FT. ALT.				SLOWER CHANGE
		BEST I.A.S.	FT./MIN.	TIME FROM S.L.	FUEL FROM S.L.	BEST I.A.S.	FT./MIN.	TIME FROM S.L.	FUEL FROM S.L.	BEST I.A.S.	FT./MIN.	TIME FROM S.L.	FUEL FROM S.L.	BEST I.A.S.	FT./MIN.	TIME FROM S.L.	FUEL FROM S.L.	BEST I.A.S.	FT./MIN.	TIME FROM S.L.	FUEL FROM S.L.	
15,000	COMBAT FERRY	165	1850	3	60	165	1350	6	60	155	1200	10	75	155	1000	14	90	155	900	19	110	
		165	750	7	70	165	750	14	70	155	700	21	90	155	600	28	110	155	500	37	135	
14,000	COMBAT FERRY	165	2050	2.4	57	165	2050	4.9	57	155	1400	8.3	70	155	1250	12.1	83	155	1050	16.4	98	
		165	850	6	65	165	850	12	65	155	800	18	85	155	750	25	100	155	600	32	120	
12,600	COMBAT FERRY	165	2300	2.2	55	165	2300	4.4	55	155	1550	7.2	66	155	1400	10.6	78	155	1250	14.5	91	
		165	1000	5	60	165	1000	10	60	155	950	15	75	155	900	21	90	155	800	27	105	

NOTE: INCREASED ELAPSED CLIMBING TIME 10% FOR EACH 10°C ABOVE 0°C FREE AIR TEMPERATURE

FUEL INCLUDES WARM-UP AND TAKE-OFF ALLOWANCE

LANDING DISTANCE (IN FEET)																			
GROSS WEIGHT (IN LBS.)	BEST I.A.S. Approach	HARD DRY SURFACE						FIRM DRY SOD						WET OR SLIPPERY					
		AT SEA LEVEL		AT 3,000 FT.		AT 6,000 FT.		AT SEA LEVEL		AT 3,000 FT.		AT 6,000 FT.		AT SEA LEVEL		AT 3,000 FT.		AT 6,000 FT.	
		TO CLEAR 30' OBJ.	GROUND ROLL	TO CLEAR 30' OBJ.	GROUND ROLL	TO CLEAR 30' OBJ.	GROUND ROLL	TO CLEAR 30' OBJ.	GROUND ROLL	TO CLEAR 30' OBJ.	GROUND ROLL	TO CLEAR 30' OBJ.	GROUND ROLL	TO CLEAR 30' OBJ.	GROUND ROLL	TO CLEAR 30' OBJ.	GROUND ROLL	TO CLEAR 30' OBJ.	GROUND ROLL
13,500	130	2400	1550	2600	1700	2800	1850	2600	1750	2800	1900	3000	2050	4500	3650	4900	4000	5300	4350
		2000	1200	2200	1400	2300	1500	2100	1300	2300	1500	2500	1700	3600	2800	3900	3100	4200	3400

NOTE: FOR GROUND TEMPERATURES ABOVE 35°C (95°F) INCREASE APPROACH I.A.S. 10% AND ALLOW 20% INCREASE IN GROUND ROLL.

REMARKS * FOR COMBAT CLIMB, REDUCE TO 2550 RPM AND 42 *HG WITHIN 5 MINUTES FROM START OF TAKE-OFF. IF 100 OCTANE (AMEND. #4) FUEL IS BEING USED, DO NOT EXCEED 47 *HG. FOR TAKE-OFF OR CLIMB.

LEGEND

I.A.S.: Indicated Air Speed
NOTE: All distances are average, and subject to considerable variations because of differences in pilot technique, load, C.G., etc.
RED FIGURES HAVE NOT BEEN FLIGHT CHECKED.

DIVES AND COMPRESSIBILITY

As the second world war progressed, powerful fighters such as the P-47 and P-38 were encountering something relatively new to aviation at that time. While dive bombing, pilots would sometimes not be able to pull out from the dive in time and crashed into the ground. This new generation of high-speed aircraft was capable of incredible speeds in a dive, which brings us to compressibility.

Compressibility is a term used to describe what happens when localized airflow across a wing approaches trans-sonic velocity. Extreme speed disrupts the normal airflow around a plane's wings and control surfaces. The greater the altitude, the lower the speed at which it occurs. In a dive, if your plane becomes nose heavy and your elevators do not respond to control input (as if they were « frozen »), compressibility is generally the answer.

Here are a few pointers that are important to remember when performing a dive.

1. Before diving, trim the plane slightly tail heavy so that you need a little stick pressure to hold the plane in the dive.
2. Start dives from level flight by pushing the nose down. Do NOT start a dive from a Split S.
3. In a high-speed dive, decrease manifold pressure to keep it from over boosting the engine and do not retard the throttle suddenly; the nose becomes heavy and the dive steepens.
4. Recover gradually from a high-speed dive; sharp pullouts place unnecessary loads on the wings and control surfaces.
5. Aileron forces become high at speeds above 350 mph IAS. At least 12000 ft should be allowed for recovery from dives at limiting speed (500 mph IAS).
6. NEVER dive with cowl flaps open. This is due to many reasons, mainly the fact that you risk overcooling your engine and that the cowl flaps create turbulence that make the aircraft unstable above 250 kts.
7. Due to compressibility effect, diving at high altitude will produce a tendency for the airplane to nose down. If extremely high indicated speeds are reached, the elevator tab will have to be used for recovery.
8. Except in extreme emergencies, an indicated air speed of 400 mph should not be exceeded above 25,000 ft.
9. The P-47 is equipped with compressibility recovery flaps that can be used to pull out from a high-speed dive.

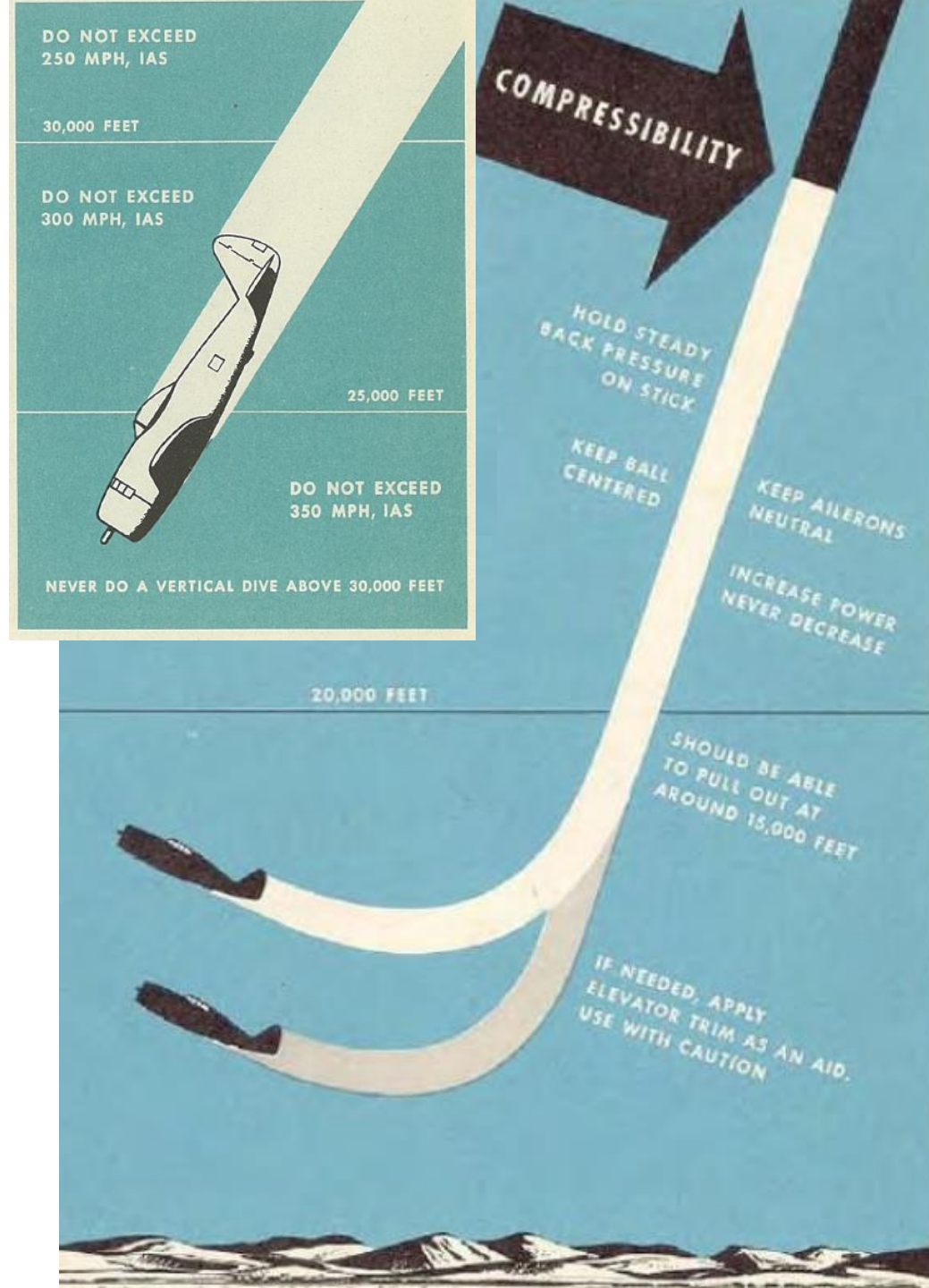

COMPRESSIBILITY RECOVERY FLAPS

Compressibility recovery flaps can be used to aid recovery from dives within compressibility speeds. These surfaces are operated by two electric, reversible, intermittent motors synchronized by flexible shafting. Electromagnetic brakes and couplings are integrated into the flaps control system to prevent overstepping of the limit position.

The 21 deg deviation angle of the flaps ensures that the safe optimum G-force is maintained when pulling away from a dive.

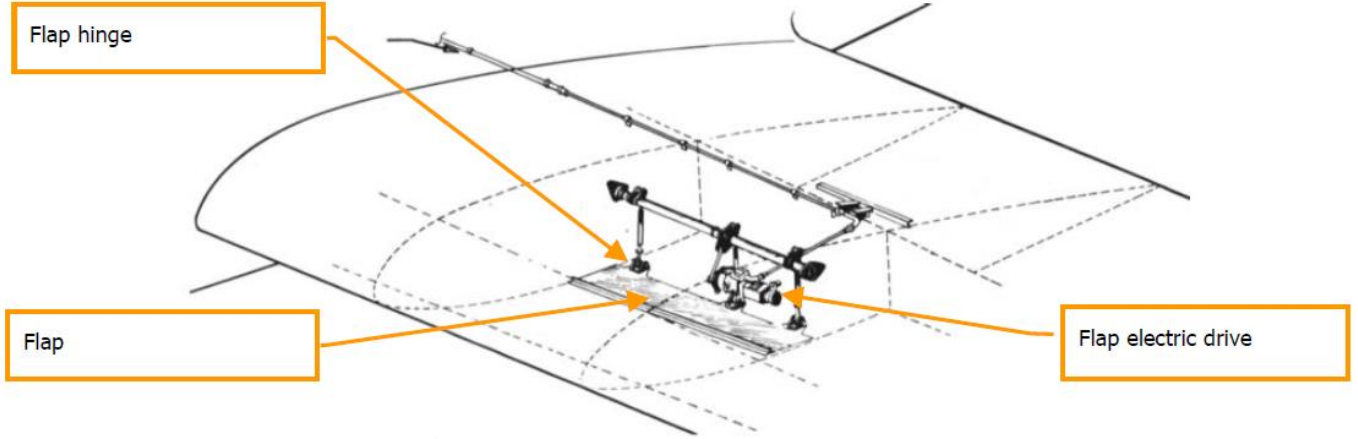

Compressibility Recovery Flaps Switch

- UP: Compressibility Flaps Up/Retracted
- DOWN: Compressibility Flaps Down/Deployed

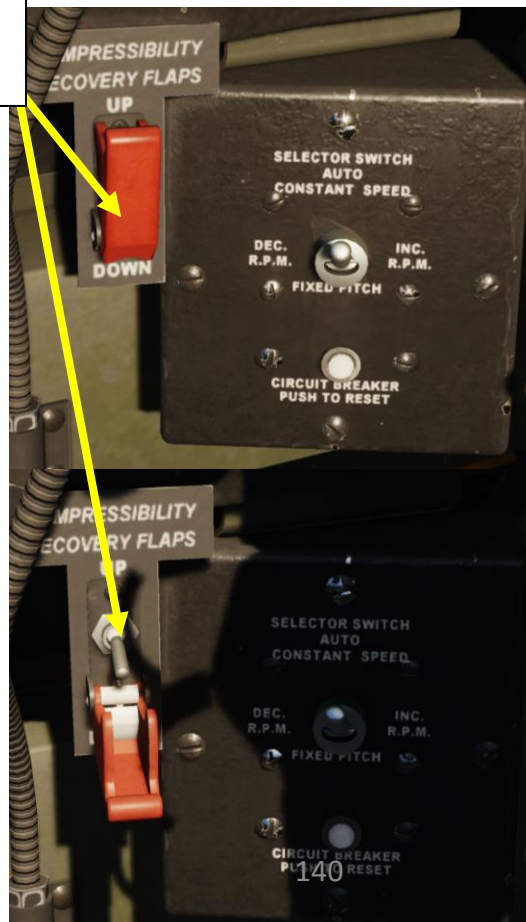

AEROBATICS

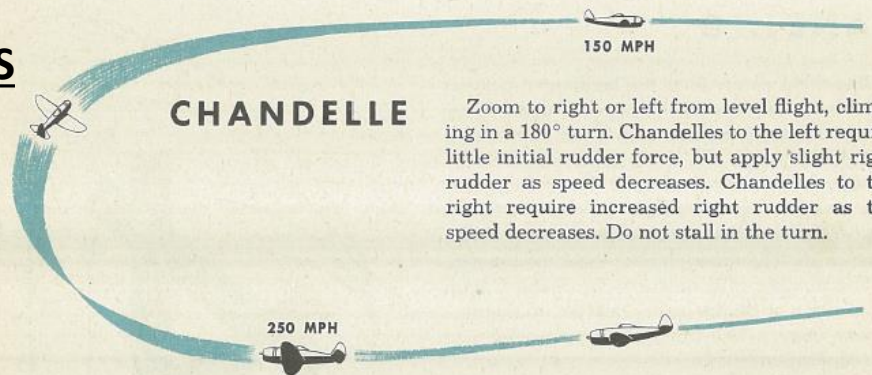

CHANDELLE

Zoom to right or left from level flight, climbing in a 180° turn. Chandelles to the left require little initial rudder force, but apply slight right rudder as speed decreases. Chandelles to the right require increased right rudder as the speed decreases. Do not stall in the turn.



LAZY 8

Requires no unusual control movements. You need good coordination to keep the ball centered.

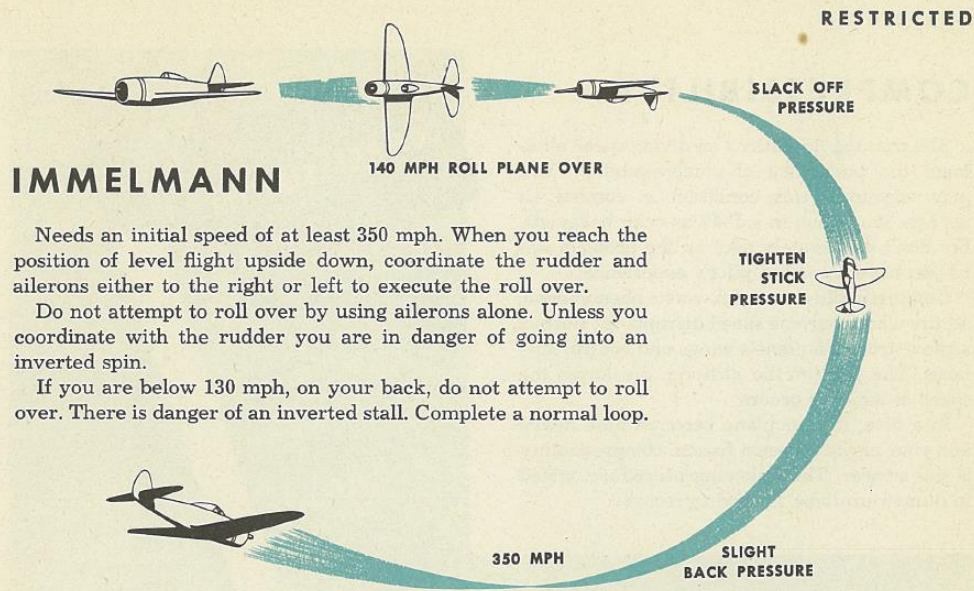

IMMELMANN

Needs an initial speed of at least 350 mph. When you reach the position of level flight upside down, coordinate the rudder and ailerons either to the right or left to execute the roll over.

Do not attempt to roll over by using ailerons alone. Unless you coordinate with the rudder you are in danger of going into an inverted spin.

If you are below 130 mph, on your back, do not attempt to roll over. There is danger of an inverted stall. Complete a normal loop.

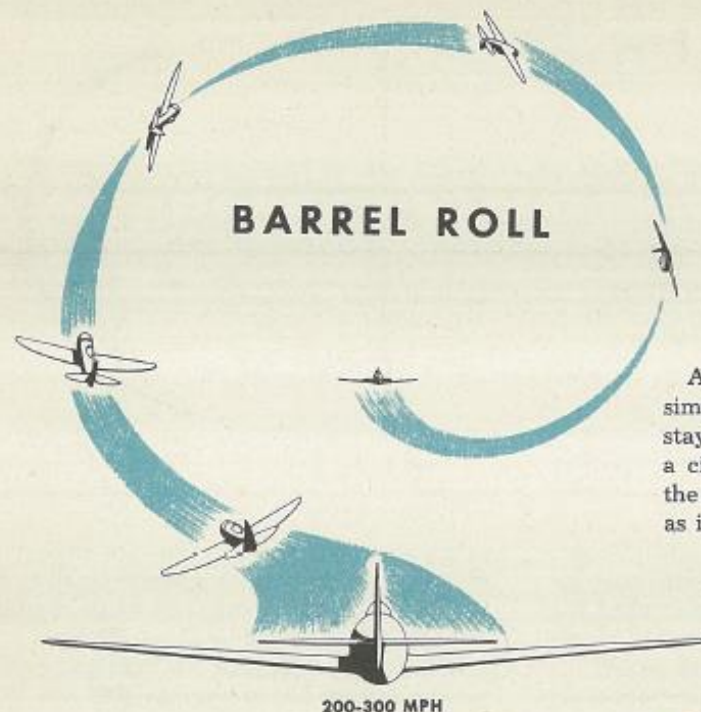

BARREL ROLL

About the same as a slow roll, but simpler to execute. The nose does not stay on a point, but revolves around a circle. You fly the plane through the maneuver instead of holding it in, as in a slow roll.

LOOP

Pull in slightly at the start of the climb to avoid killing your speed, then pull in tighter to hurry the plane on its back. Slack off on stick pressure to avoid stalling when the speed drops below 200 mph.

Do not use any aileron, and only enough rudder to keep the nose straight. If your speed is less than 130 mph at the top of the loop, allow the nose to fall through slowly before applying back pressure to recover.

Recover in the same direction as the start. If the initial speed is above 300 mph, there should be a slight gain in altitude.

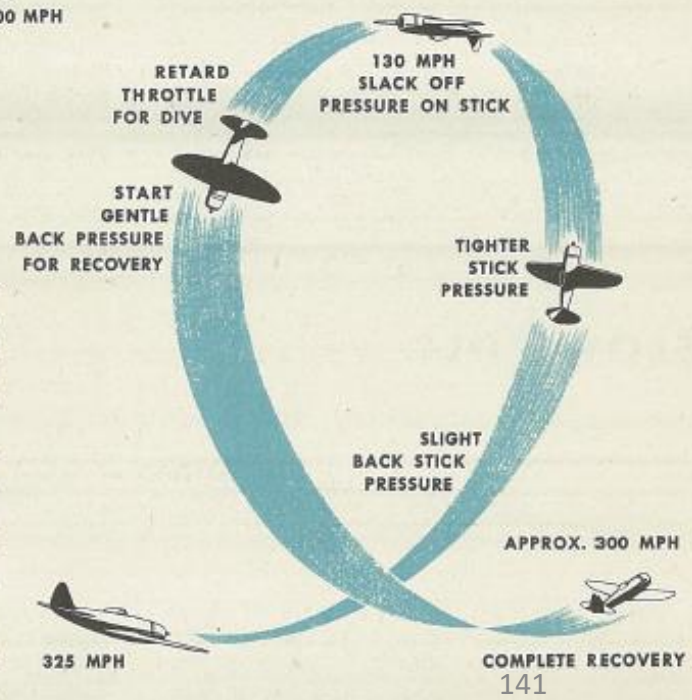



AEROBATICS

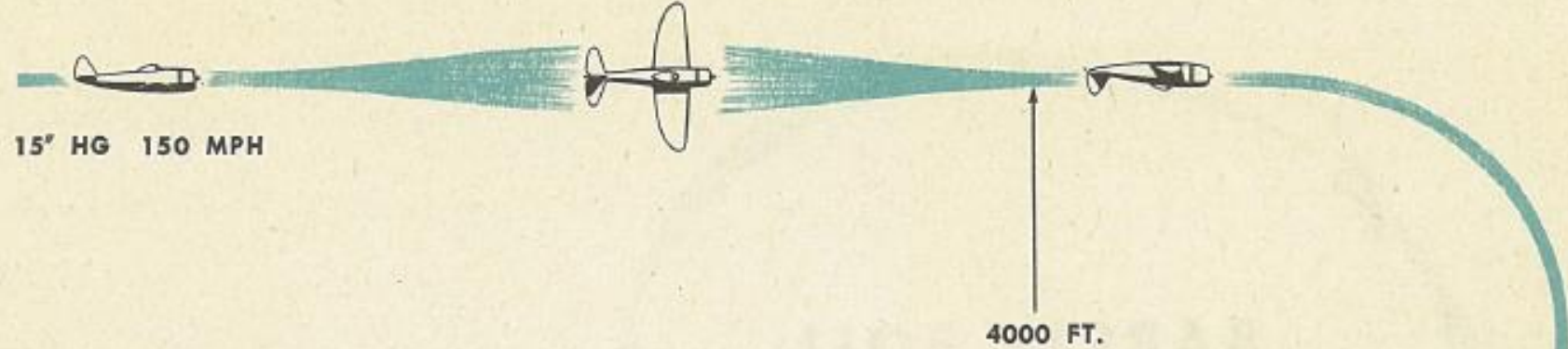

SPLIT-S (ALSO KNOWN AS HALF ROLL)



SLOW ROLL

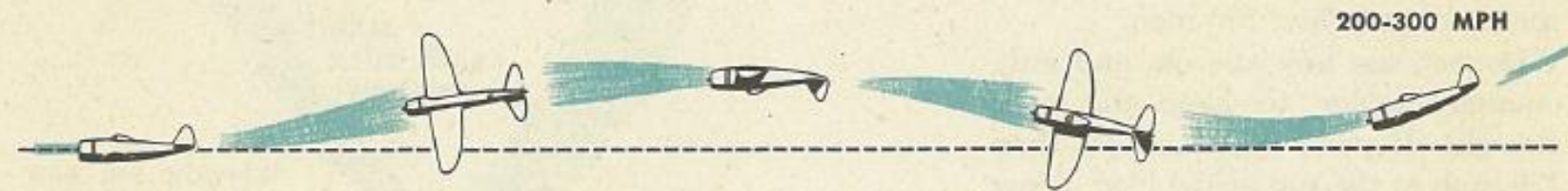

Enter the roll with the nose about 10° above the horizon. Move the stick to right or left, using the necessary rudder to keep the nose on a point. As the plane rolls on its back, use forward stick to keep the nose up.

You require little rudder control while executing the maneuver at about 200 mph. Perform climbing slow rolls with an initial speed of around 300 mph. Little rudder control is required for a climbing roll.

PART 9 - WEAPONS

**P-47D
THUNDERBOLT**



ARMAMENT OVERVIEW

- 8 x 0.50 cal M2 machineguns (3400 rounds total)
 - 425 rounds per gun
 - Machine gun rate of fire is 800-890 shots per minute.
 - Machine gun barrels overheat when firing long salvos (recommended firing time is 3 seconds per burst).
- M30A1 100 lbs Bombs (wing-mounted or belly-mounted)
- M57 250 lbs Bombs (wing-mounted or belly-mounted)
- M64 500 lbs Bombs (wing-mounted or belly-mounted)
- M65 1000 lbs Bombs (wing-mounted only)
- 10 x 5-inch HVAR Rockets – P-47D-40 only
- 6 x 4.5-inch M-8 rockets (with M10 tubular launchers) – P-47D-40 only



4.5 inch M-8 rockets

M2 0.50 Cal Machineguns



M65 1000 lbs Bomb

M64 500 lbs Bomb



5-inch HVAR Rockets

WEAPON CONTROLS (P-47D-30 EARLY SERIES)

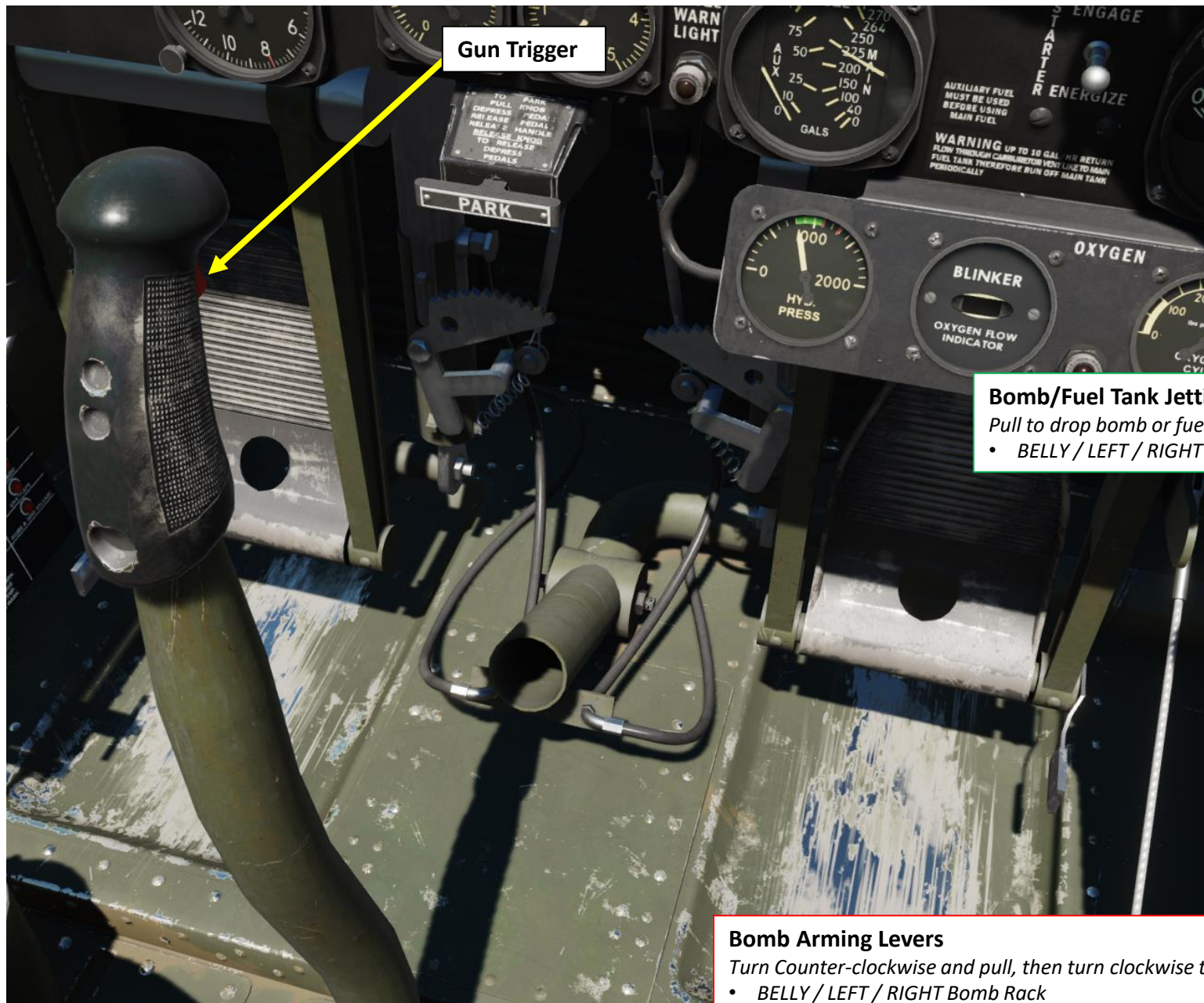

Gun Trigger

Bomb/Fuel Tank Jettison (Drop) Levers
Pull to drop bomb or fuel tank.
• BELLY / LEFT / RIGHT Bomb Rack



Bomb Arming Levers
Turn Counter-clockwise and pull, then turn clockwise to arm.
• BELLY / LEFT / RIGHT Bomb Rack

WEAPON CONTROLS (P-47D-30 LATE SERIES)

Weapons (Bomb) Release Button



Gun Trigger

Bomb Arming Levers
Turn Counter-clockwise and pull, then turn clockwise to arm.
• BELLY / LEFT / RIGHT Bomb Rack



Left Hardpoint Jettison Handle

Right Hardpoint Jettison Handle

Belly Hardpoint Jettison Handle

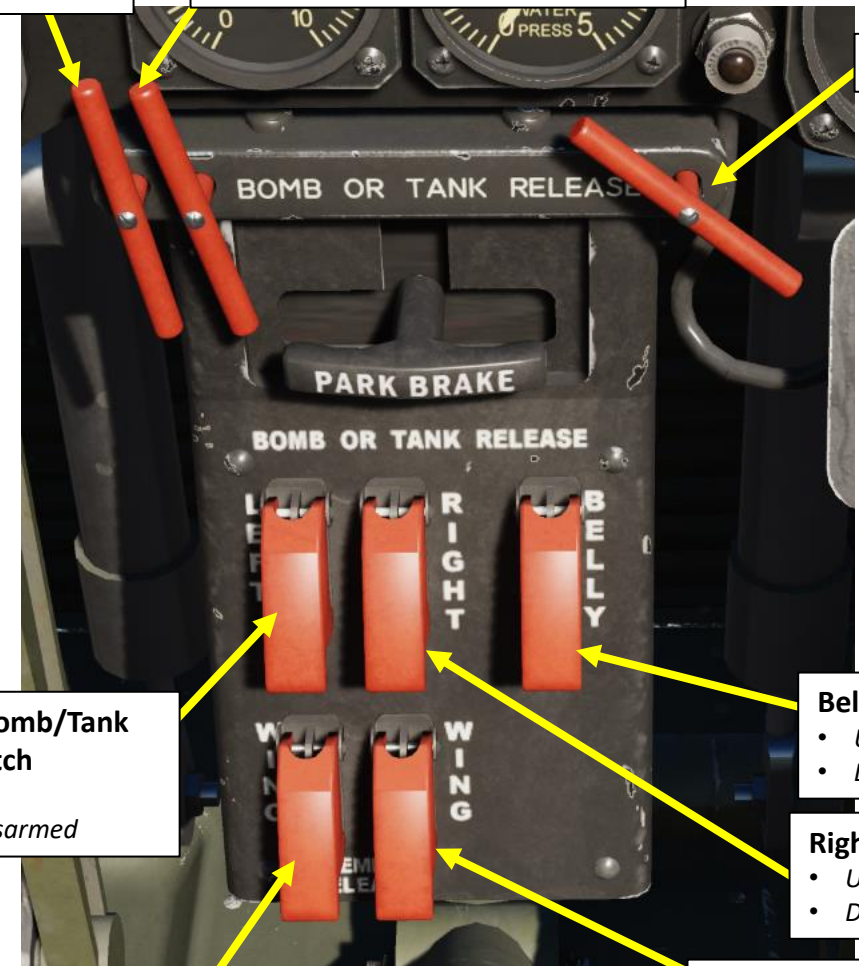

Left Wing Bomb/Tank Arming Switch
• UP: Armed
• DOWN: Disarmed

Belly Bomb/Tank Arming Switch
• UP: Armed
• DOWN: Disarmed

Right Wing Bomb/Tank Arming Switch
• UP: Armed
• DOWN: Disarmed

Left Wing Chemical Tank Arming Switch
• UP: Armed
• DOWN: Disarmed

Right Wing Chemical Tank Arming Switch
• UP: Armed
• DOWN: Disarmed

WEAPON CONTROLS (P-47D-40 SERIES)

Weapons (Bomb/Rocket) Release Button

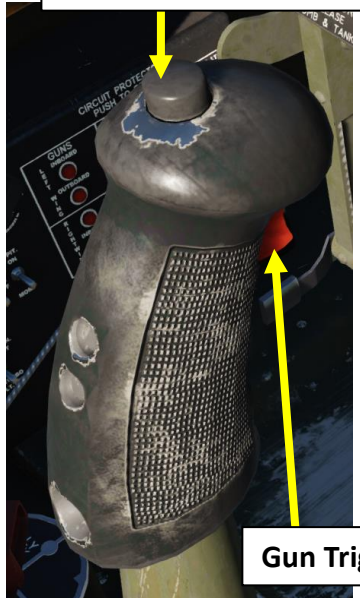

Gun Trigger

Left/Right Wing Chemical Tank Arming Switches

- UP: Armed
- DOWN: Disarmed



Rockets or Bomb & Tank Selector Switch

- UP: Bomb & Tank
- DOWN: Rockets

Bomb/Tank/Rocket Safety Switch (under red guard cover)

- UP: Armed / Ready
- DOWN: Safety is ON

Left/Right Wing or Belly Bomb/Tank Arming Selector Switch

- UP: Armed
- DOWN: Disarmed

Bomb Arming Levers

Turn Counter-clockwise and pull, then turn clockwise to arm.

- BELLY / LEFT / RIGHT Bomb Rack



Rocket Firing Mode Control

- OFF: Rockets OFF
- SINGLE: Single Rocket Fire
- AUTO: Rocket Ripple Fire

Rocket Salvo Size Selector

- Handle Pointed UP (ALTERNATE) – Upon Weapon Release button press, a single rocket can be fired
- Handle Pointed DOWN (DUAL) – Upon Weapon Release button press, rockets are fired from both wings in order to maintain aircraft roll stability

Left Hardpoint Jettison Handle

Right Hardpoint Jettison Handle

Belly Hardpoint Jettison Handle

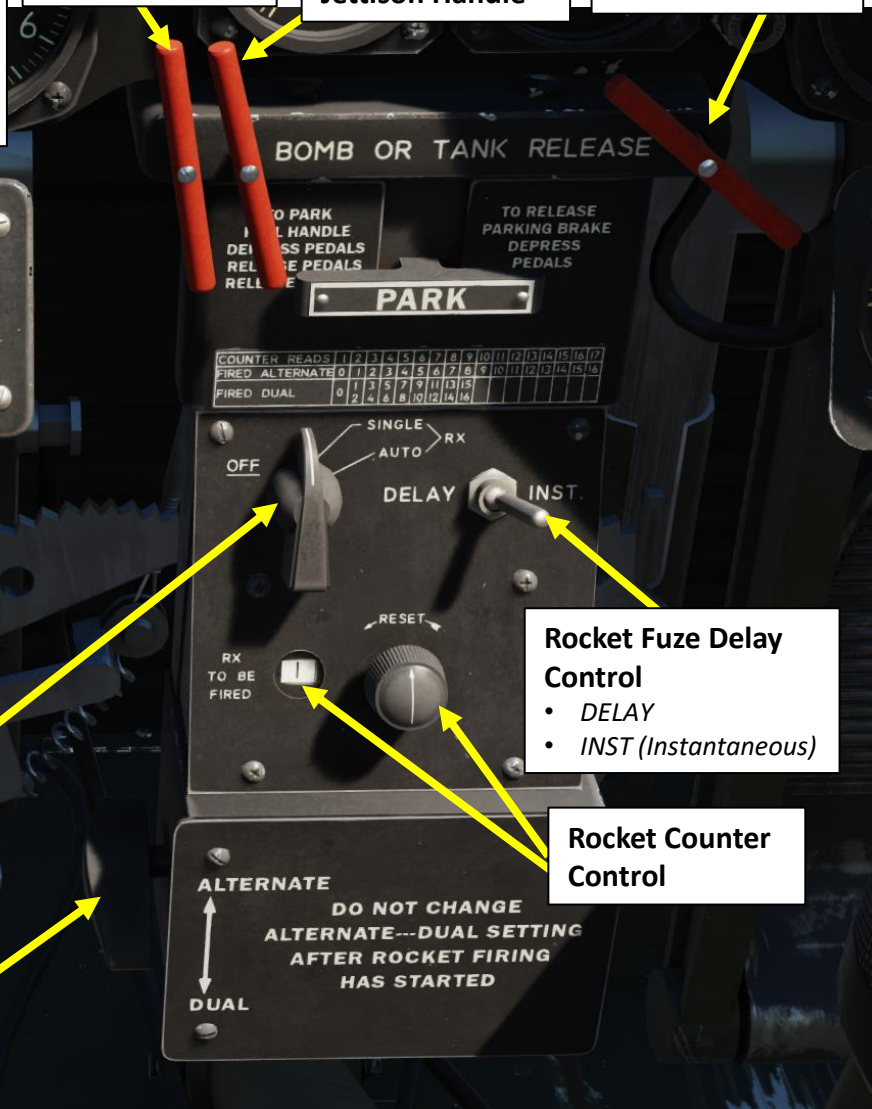

Rocket Fuze Delay Control

- DELAY
- INST (Instantaneous)

Rocket Counter Control



MARK VIII GUNSIGHT (P-47D-30 EARLY SERIES)

Your gunsight will show you where to shoot and when to shoot a target. The Mark VIII is an older fixed gunsight when compared to the K-14 gyro gunsight.

Interestingly, the Mark VIII is termed the “100 mph sight” since a 90 deg deflection shot requires one radius lead for each 100 mph speed of the target.

- When you are looking through the ring, at 1000 yards distance, the ring covers an area 100 yards in diameter
- When you are looking through the ring, at 1000 ft distance, the ring covers an area 100 ft in diameter

All you need to do to turn on the gunsight is to:

1. Rotate Gunsight Rheostat to ON
2. Set the Gun Safety Switch to GUNS & CAMERA (DOWN)



Gunsight Rheostat



Gun Safety Switch and Safety Guard (Red)



Mark VIII Gunsight

MARK VIII GUNSIGHT (P-47D-30 EARLY SERIES)

CAMERA GUNNERY

Camera gunnery teaches you to estimate:

1. RANGE
2. CORRECT LINE OF FLIGHT OF TARGET
3. DEFLECTION

Master the three fundamentals, learn to fly smoothly, and you can bring down an enemy airplane every time. Be weak in one of the

fundamentals and you miss the target.

The P-47's Mark VIII gunsight is termed a 100 mph sight. That is, a 90° deflection shot requires one radius lead for each 100 mph speed of the target. When you are looking through the ring, at 1000 yards distance, the ring covers an area 100 yards in diameter; at 1000 feet the ring covers 100 feet, etc.

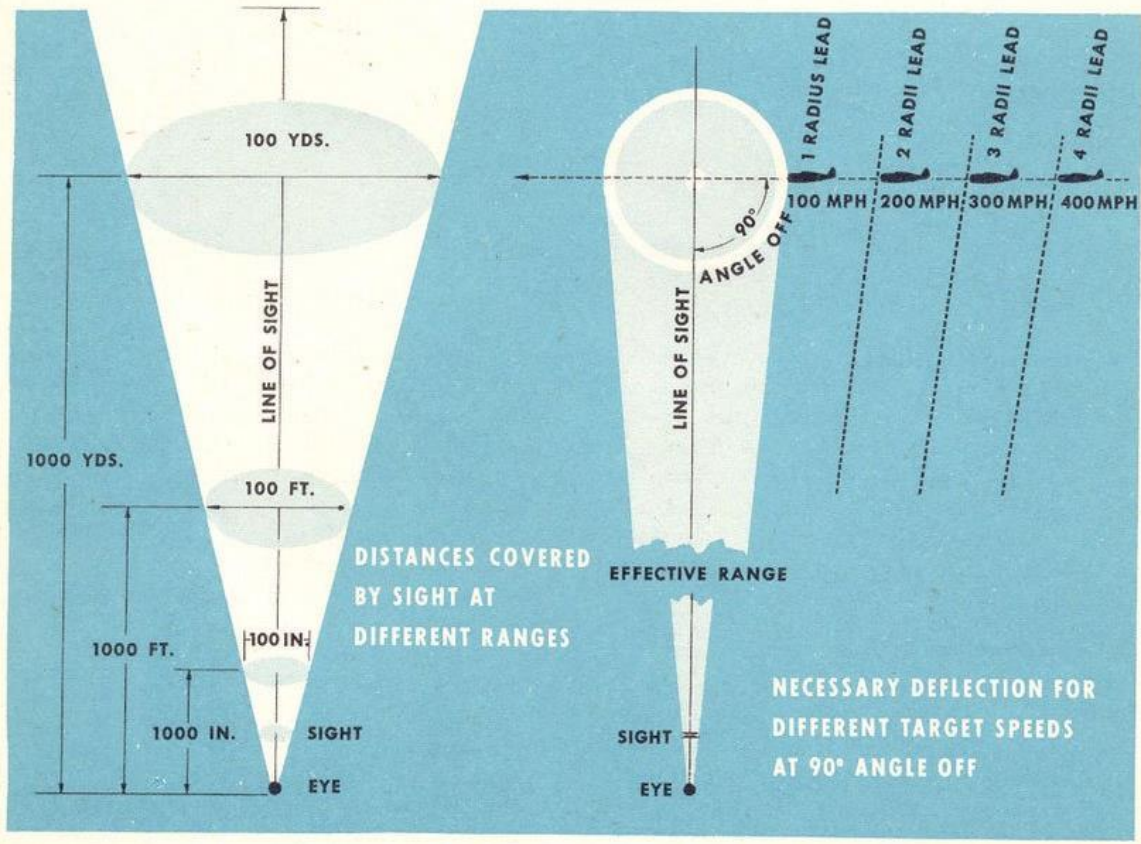

SIGHT PICTURES SHOWING APPROXIMATE SIZE OF TARGET (P-47) WHEN SEEN IN SIGHT AT VARIOUS RANGES

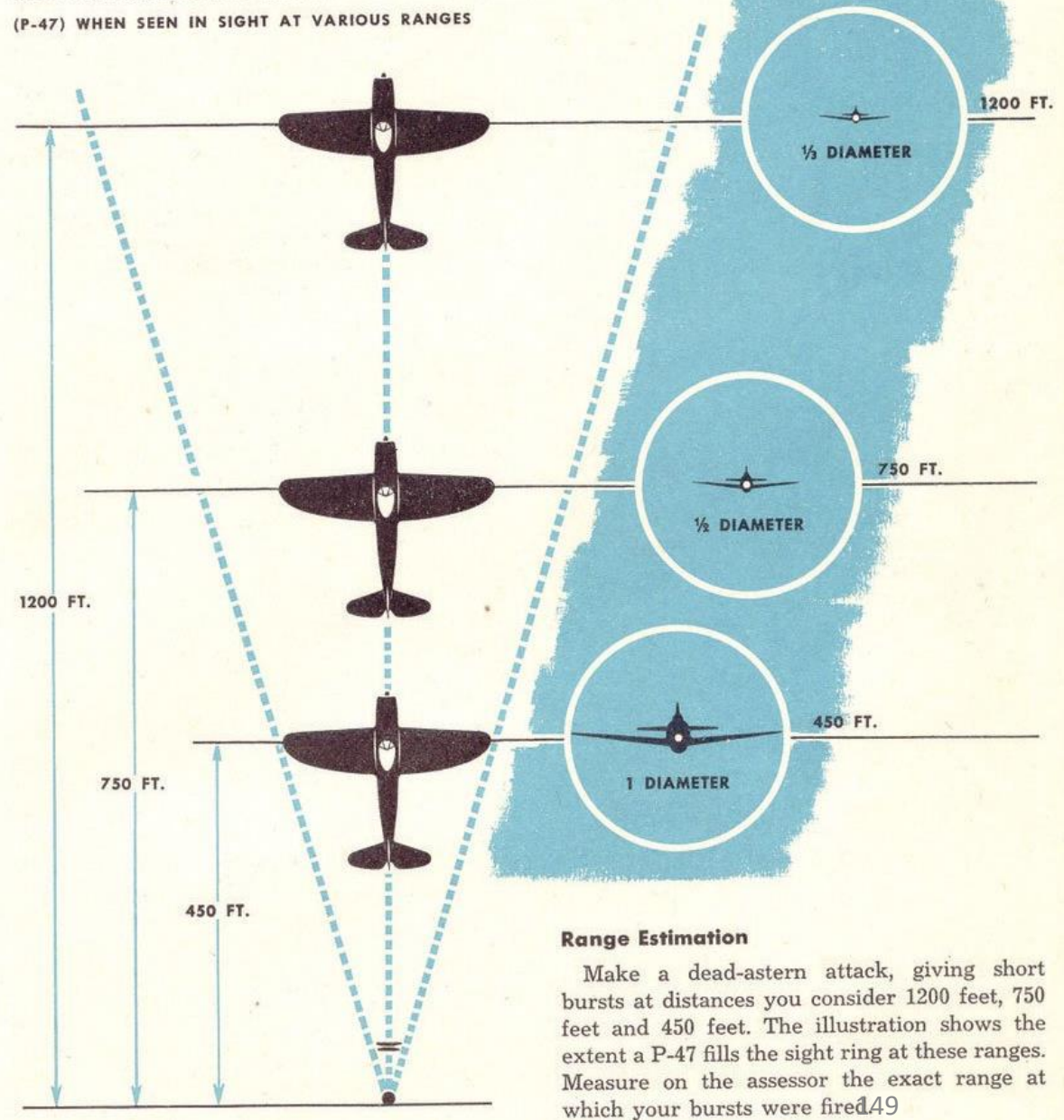

Range Estimation

Make a dead-astern attack, giving short bursts at distances you consider 1200 feet, 750 feet and 450 feet. The illustration shows the extent a P-47 fills the sight ring at these ranges. Measure on the assessor the exact range at which your bursts were fired.

K-14 GYRO GUNSIGHT (P-47D-30 LATE & -40 SERIES)

Your gunsight will show you where to shoot and when to shoot a target.

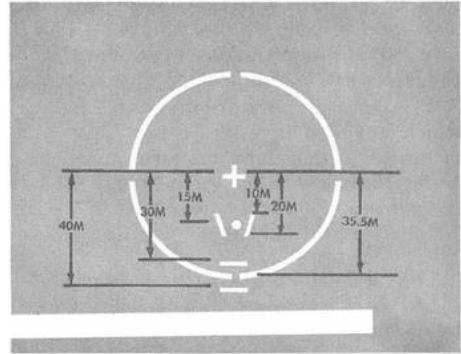

Fixed Reticle Pattern, K-14 Sight, Diameter 71.12 Mils

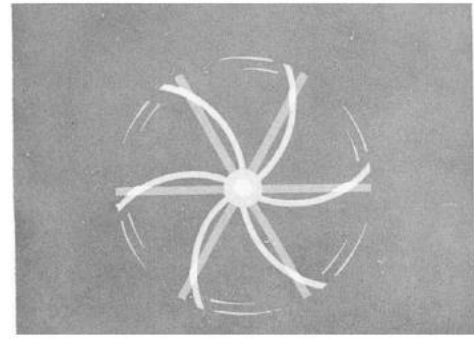

Movable Reticles

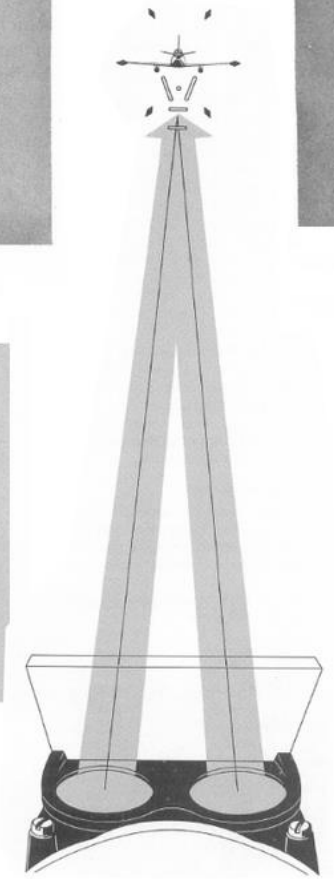
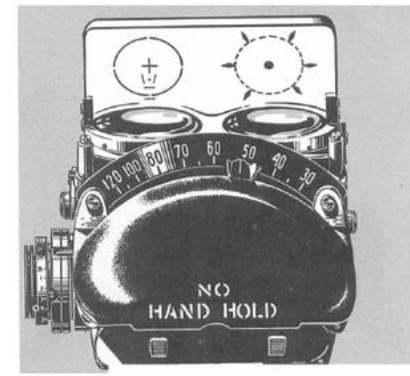

Gyro sight

Fixed sight

Fixed sight with ring mask



K-14 GYRO GUNSIGHT (P-47D-30 LATE & -40 SERIES)

To use the gunsight properly:

1. Flip Gun Safety Guard (Red) and set Gun Safety Switch DOWN (GUNS & CAMERA)
2. Rotate Gunsight Rheostat to ON
3. Set Gunsight Fixed Reticle Mask Lever as desired (DOWN if you want to hid the fixed sight, UP if you want to display the fixed sight)
4. Set gunsight range scale (recommended: 1100 ft) by using your twist-grip throttle (“Gunsight Range to Target Decrease/Increase” controls)
5. Set gunsight wingspan scale (recommended: 32 ft for a Bf.109 or a FW190) by using the gunsight wingspan selector
6. Fire guns when the wings of the target fit within your gunsight gyro reticle

CONTROL OPTIONS						
P-47D-30 Sim	All	<input type="checkbox"/> Foldable view	Reset category to default	Clear category	Save profile as	Load profile
Action	Category	Keyboard	Throttle - HOTAS...	Saitek Pro Flight ...	Joystick - HOTAS ...	T...
Gunsight range to target Decrease	K-14 gunsight	.			JOY_BTN17	
Gunsight range to target Increase	K-14 gunsight	;			JOY_BTN15	
Gunsight target span Decrease	K-14 gunsight	/			JOY_BTN16	
Gunsight target span Increase	K-14 gunsight	,			JOY_BTN18	



Gunsight Rheostat



Gun Safety Switch and Safety Guard (Red)



Twist Grip – Gunsight Target Range Control

Gunsight Target Wingspan Scale (ft)

Gunsight Fixed Reticle Mask Lever
 • UP: ON
 • DOWN: OFF

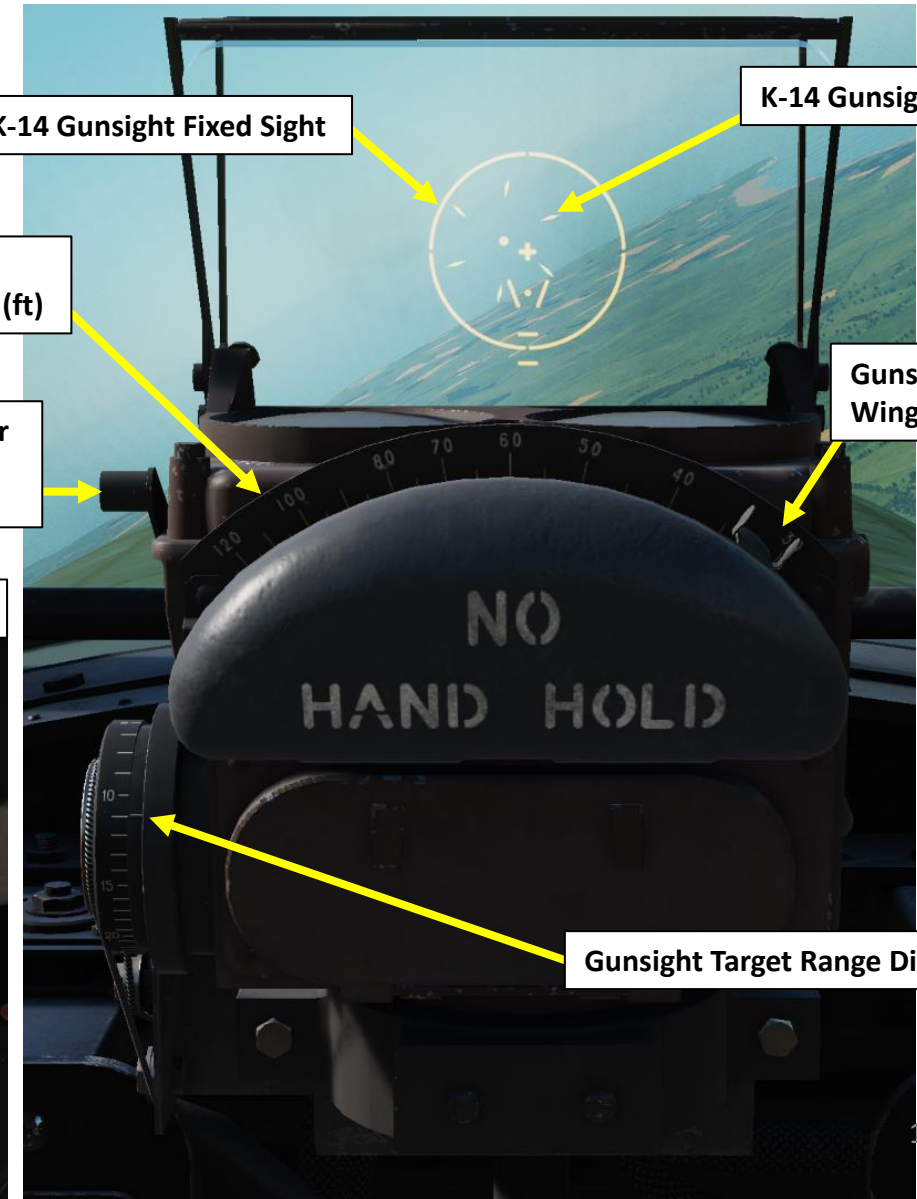

K-14 Gunsight Fixed Sight

K-14 Gunsight Gyro Sight

Gunsight Target Wingspan Selector

Gunsight Target Range Dial (x100 ft)

M2 BROWNING 0.50 CALIBER MACHINE GUNS (P-47D-30 LATE & -40 SERIES)

1. Flip Gun Safety Guard (Red) and set Gun Safety Switch DOWN (GUNS & CAMERA)
2. Rotate Gunsight Rheostat to ON
3. Set Gunsight Fixed Reticle Mask Lever as desired (DOWN if you want to hide the fixed sight, UP if you want to display the fixed sight)
4. Set gunsight range (a) and wingspan scale (b) as required (see K-14 Gyro Gunsight tutorial)
5. Place the wings of the target fit within your gunsight gyroscope reticle
6. Squeeze the machinegun trigger (Spacebar) to fire machineguns.

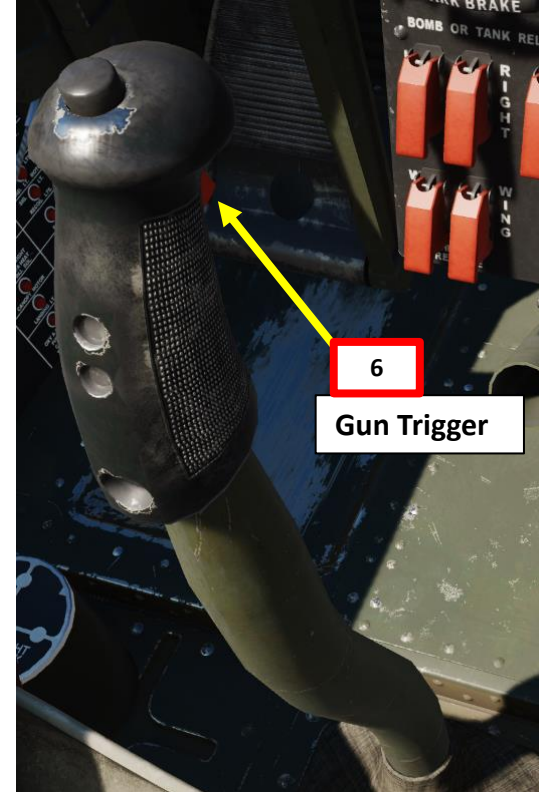
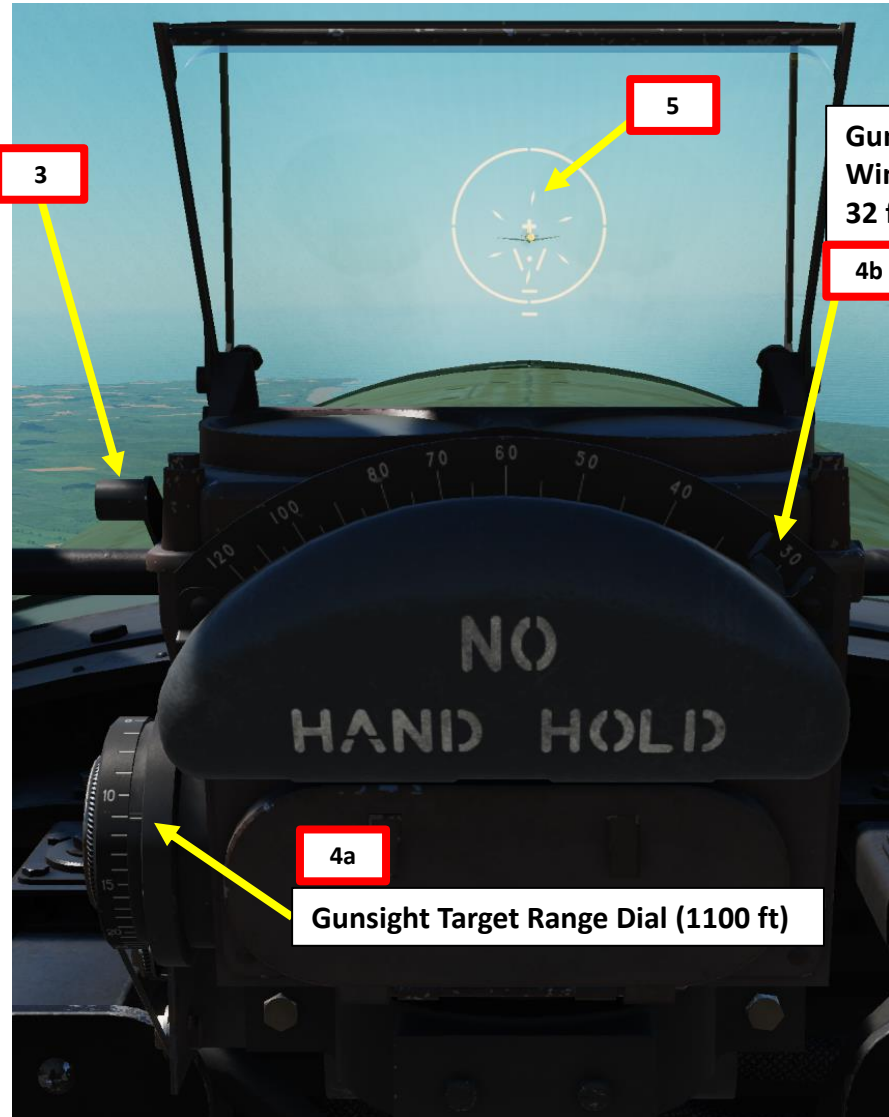



Note:
The P-47 has enough rounds for about 30 seconds of continuous fire. In order to avoid gun jamming or gun overheating, pilots typically used 2-second bursts.

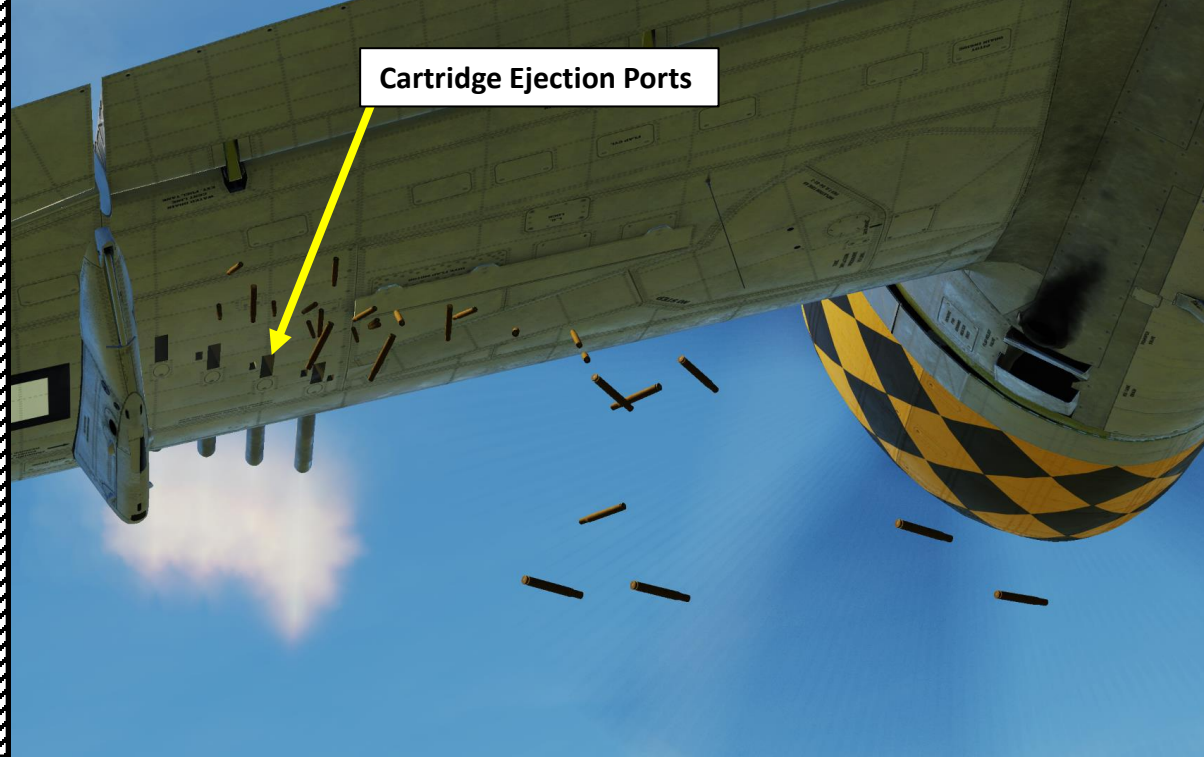

ARMAMENT BALLISTICS

SIDE VIEW OF TRAJECTORIES

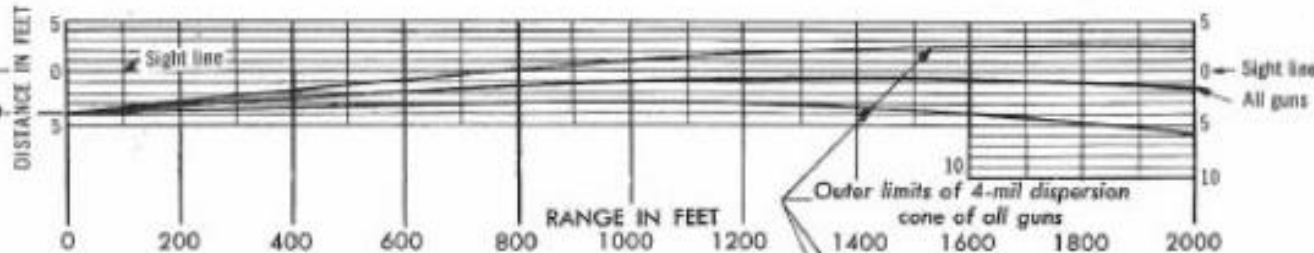

PLAN VIEW OF TRAJECTORIES

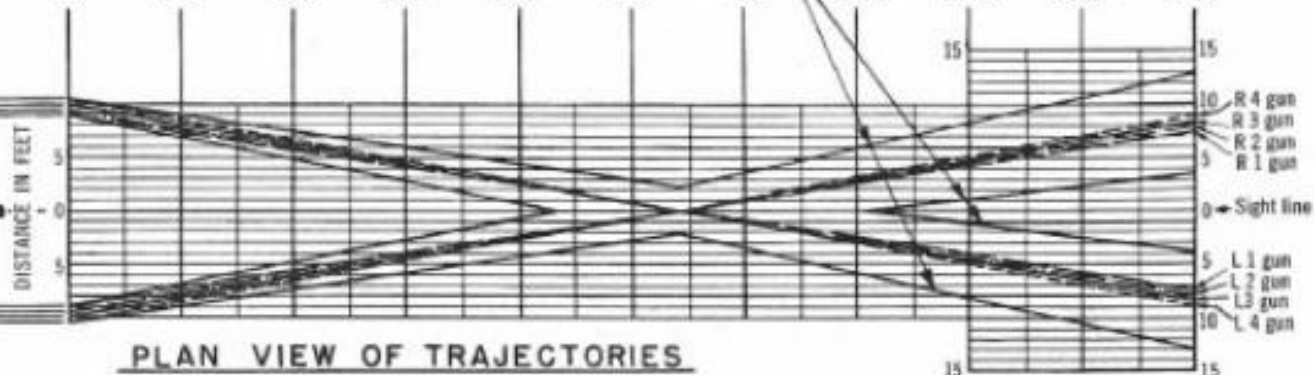

PLAN VIEW OF TRAJECTORIES

DISPERSION PATTERNS

Based on 4-mil dispersion cone

- ⊙ SIGHT PIP
- CAMERA OR CENTER OF PICTURE FRAME

NOTE

Dotted circles are bullet patterns of 1000-ft range when firing is done at various "gs" shown

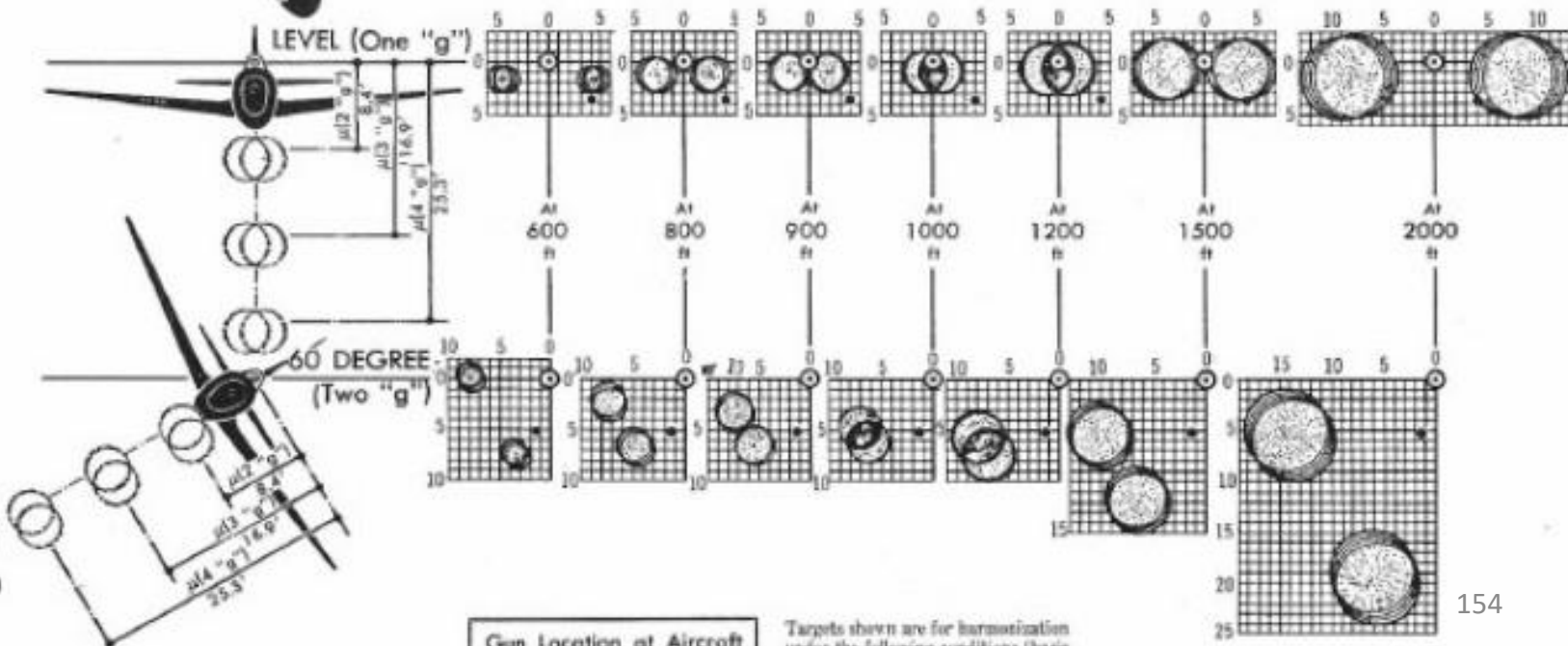

Gun Location at Aircraft

Targets shown are for harmonization under the following conditions (base harmonization only)

ARMAMENT BALLISTICS

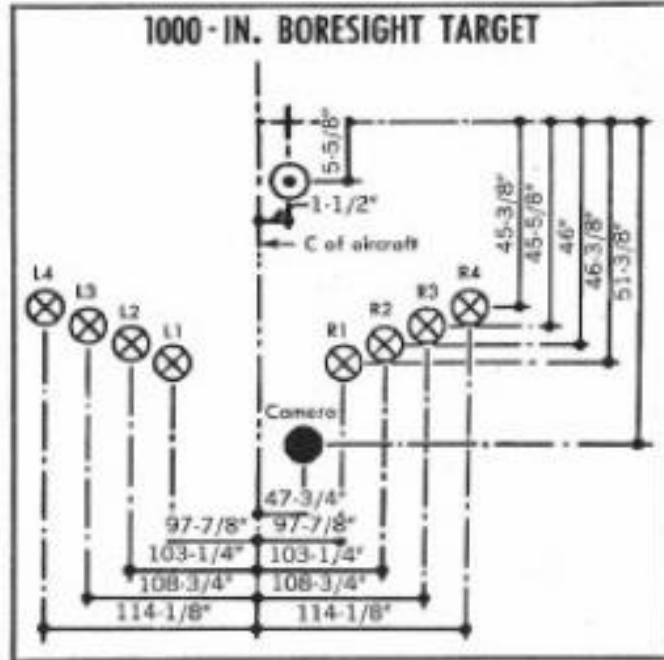

Gun Location of Aircraft

Cal 0.50	Vert*	Horiz†
L&R No. 1 guns	47.344"	107.875"
L&R No. 2 guns	46.969"	113.844"
L&R No. 3 guns	46.594"	119.813"
L&R No. 4 guns	46.219"	125.78"
Camera	45.750"	47.813"

*From sight †From plane center line.

Targets shown are for harmonization under the following conditions (basic harmonization):

Cal IAS: 300 mph Alt: 15,000 ft
 TAS: ±373 mph Wt: 14,000±250 lb
 Angle of attack (cep): 11 mils nose up
 Level flight: (1 "g")

- ⊕ Mark where line from sight is parallel to fuselage leveling lugs.
- ⊙ Mark where sight pip is aimed for harmonization with bullet patterns (sight setting for harmonization).
- ⊗ Mark where bore is aimed for 1000-in. and 900-ft. targets.
- Mark for center of impact of 30 rounds at 900-ft. target.
- Mark where camera is aimed making camera parallel to sight line. This point represents the center of the picture frame.

Applied Ballistics & Design Sec., Prost Div., A.A.F.P.S.C., Eglin Field, Fla. Date: 6-9-44.

TRAJECTORY DATA

Forward Fire

Gun: Cal .50
 Ammunition: APM-2
 Muz vel, ft/sec: 2700
 Authority: Aberdeen data FT. 50 AC M-1; see last ind. to letter from Ord. Dept., Eglin Field, Fla., April 15, 1944 to Chief of Ordnance, Washington, D.C.

BASIC HARMONIZATION

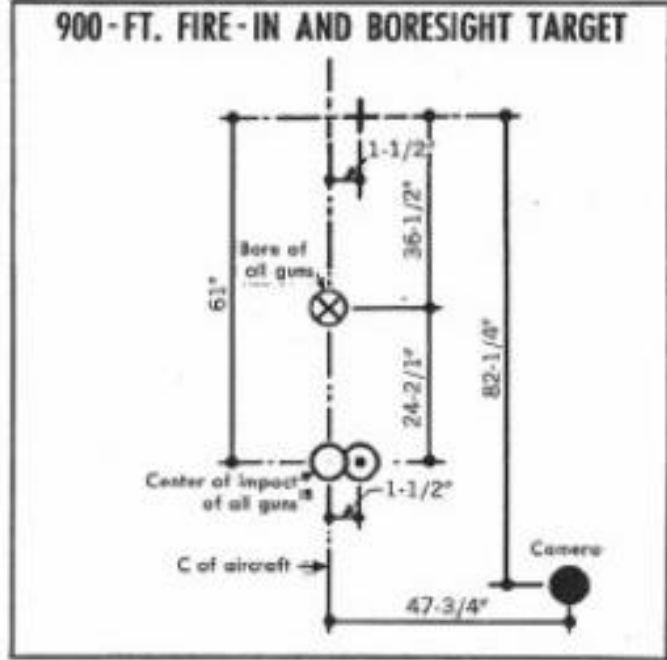
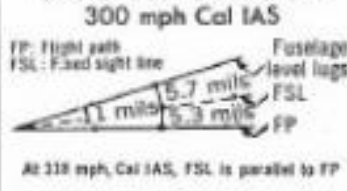

		Flight Angle: LEVEL FLIGHT					
Alt.	Cal IAS	TAS	Mil Angle "μ"				
			1 "g"	2 "g"	3 "g"	4 "g"	
0'	250	250	+2.1	+10.7	+19.2	+27.8	
	300	300	-0.3	+6.7	+13.7	+20.7	
	350	350	-2.2	+3.8	+9.5	+15.4	
	400	400	-4.0	+0.9	+6.2	+11.2	
	450	450	-4.9	-0.6	+3.7	+8.0	
7000'	200	222	+6.1	+18.0	-	-	
	250	276	+2.4	+11.8	+21.1	+30.5	
	300	331	-0.2	+7.4	+15.1	+22.7	
	350	386	-2.2	+4.2	+10.5	+16.9	
	400	440	-4.0	+1.1	+6.9	+12.3	
15000'	200	251	+7.0	+20.3	-	-	
	250	313	+2.9	+13.4	+23.7	+34.2	
	300	373	0	+8.4	+15.9	+25.3	
	350	434	-2.2	+4.9	+11.7	+18.8	
30000'	150	242	+16.8	-	-	-	
	200	320	+9.1	+25.5	-	-	
	250	398	+4.0	+16.8	+29.5	+42.3	
	300	471	+0.4	+10.6	+20.8	+31.0	
	350	543	-2.2	+6.2	+14.4	+22.8	

		Flight Angle: LEVEL FLIGHT			
Cal IAS	exp (Wt. = 14000 Lbs.)	Mil Angle "μ"			
		1 "g"	2 "g"	3 "g"	4 "g"
150	+161	-	-	-	-
200	+74	+185	-	-	-
250	+33	+105	+176	+248	-
300	+11	+61	+111	+161	-
350	-2	+35	+71	+108	-
440	-11	+15	+45	+73	-
450	-16	+6	+28	+50	-

		Flight Angle: 30° DIVE OR CLIMB			
Cal IAS	exp (Wt. = 14000 Lbs.)	Mil Angle "μ"			
		1 "g"	2 "g"	3 "g"	4 "g"
150	+131	-	-	-	-
200	+59	+155	+251	-	-
250	+23	+86	+148	+207	-
300	+5	+48	+92	+134	-
350	-7	+25	+56	+89	-
400	-14	+10	+34	+59	-
450	-19	0	+19	+38	-

		Flight Angle: 30° DIVE OR CLIMB					
Alt.	Cal IAS	TAS	Mil Angle "μ"				
			1 "g"	2 "g"	3 "g"	4 "g"	
0'	250	250	+0.9	+8.4	+15.8	+22.3	
	300	300	-1.2	+4.5	+11.0	+16.9	
	350	350	-3.0	+2.2	+7.3	+17.4	
	400	400	-4.3	0	+4.2	+8.7	
	450	450	-5.5	-1.8	+1.9	+5.7	
7000'	200	222	+4.5	+14.8	+25.1	-	
	250	276	+1.1	+9.3	+17.4	+25.1	
	300	331	-1.1	+5.5	+12.2	+18.6	
	350	386	-3.0	+2.5	+8.1	+13.6	
	400	440	-4.5	-0.1	+4.8	+9.6	
15000'	200	251	+5.2	+16.7	+28.2	-	
	250	313	+1.5	+10.6	+19.7	+28.2	
	300	373	-1.0	+6.3	+13.7	+20.7	
	350	434	-3.1	+3.0	+9.1	+15.2	
	400	493	-4.7	+0.3	+5.4	+10.7	
30000'	150	242	+13.3	-	-	-	
	200	320	+6.9	+21.1	+35.3	-	
	250	398	+2.3	+13.5	+24.5	+35.0	
	300	471	-0.8	+8.0	+16.9	+25.5	
	350	543	-3.4	+3.9	+11.2	+18.5	

μ = Mil angle between the fuselage leveling lugs and the flight path. This data is derived from the best available angle of attack charts, but is not guaranteed. The boresight targets and μ angles are based on this angle of the attack chart.

μ = Mil angle between the sight line and the projectiles at any range out to 2000 feet. When the mil angle is minus the projectiles are above the sight line; when plus they are below. This mil angle acts along the vertical axis of the sight. The mil angle μ is only applicable when the aircraft is harmonized as shown in the above boresight and fire-in targets.

Harmonization Chart: P-47 Airplane

BOMBING TECHNIQUES

Here are examples of two bombing techniques.

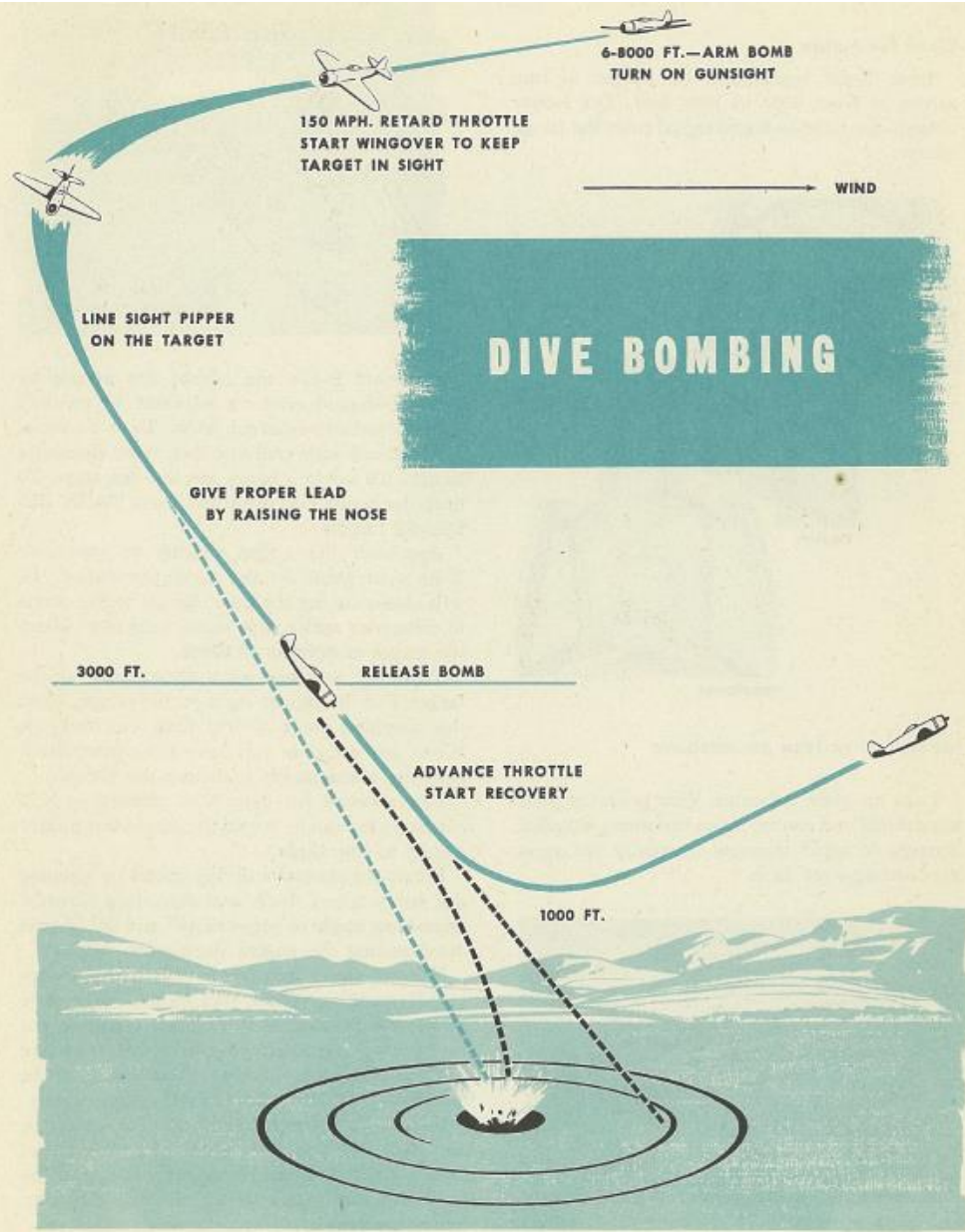

GLIDE BOMBING

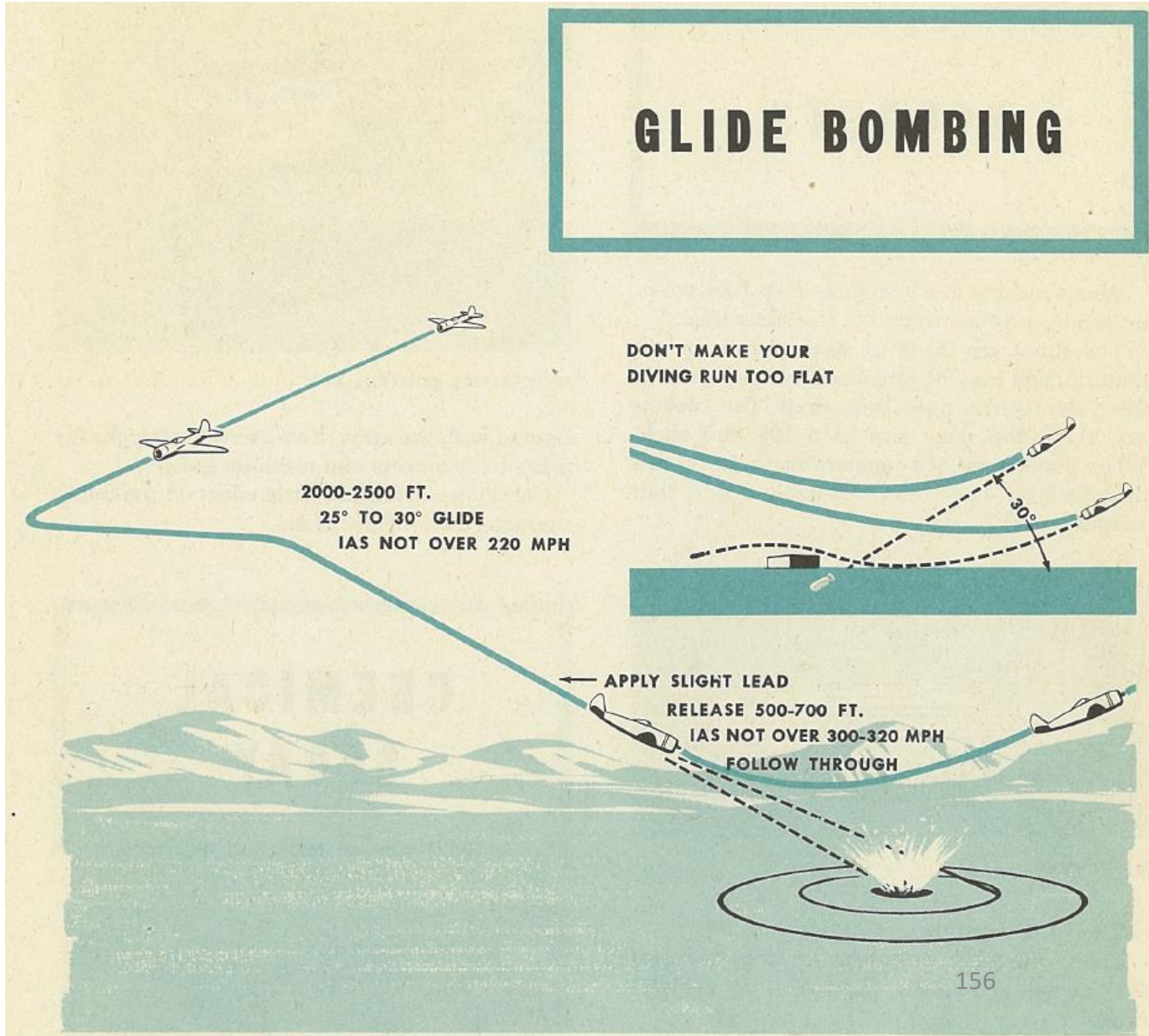

BOMB FUZES

To equip bombs with a fuze delay, contact the ground crew.

1. Open canopy
2. Press "RALT + \\" (Communication Push-to-Talk)
3. Select ground crew by pressing "F8"
4. Select "Rearm & Refuel" by pressing "F1"
5. Equip bomb on desired pylon.
6. Click on the yellow triangle on the bomb to set fuze type and delay.
7. Set fuze type and delay.
8. Click OK on the Fuze panel.
9. Repeat for each individual bomb.
10. Click OK on the Re-Arming panel.

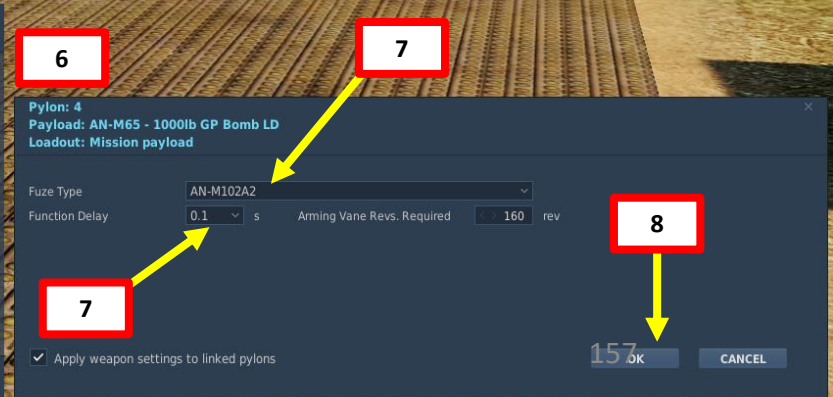
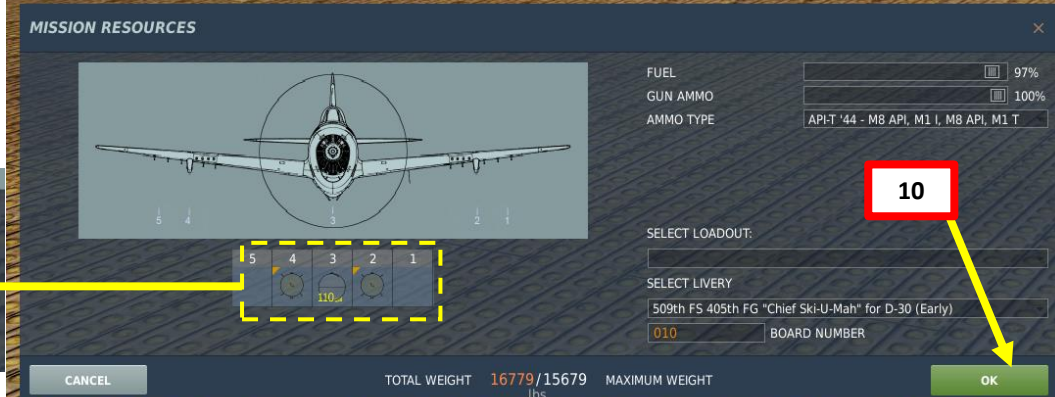
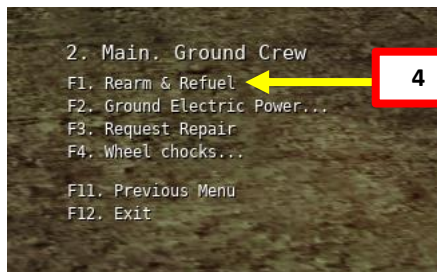
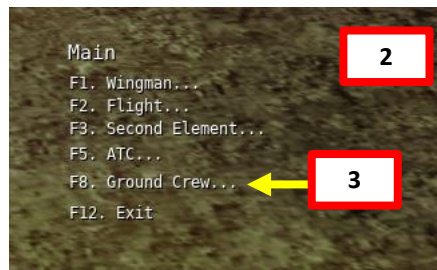

BOMBS (P-47D-30 EARLY SERIES)

1. Flip Gun Safety Guard (Red) and set Gun Safety Switch DOWN (GUNS & CAMERA)
2. Rotate Gunsight Rheostat to ON
3. Close cowl flaps before diving
4. Arm desired bomb by turning Counter-clockwise and pulling the arming lever, then turning it clockwise to arm.
5. This step is not mandatory, but I strongly recommend that you deploy the compressibility flaps to avoid overspeeding.

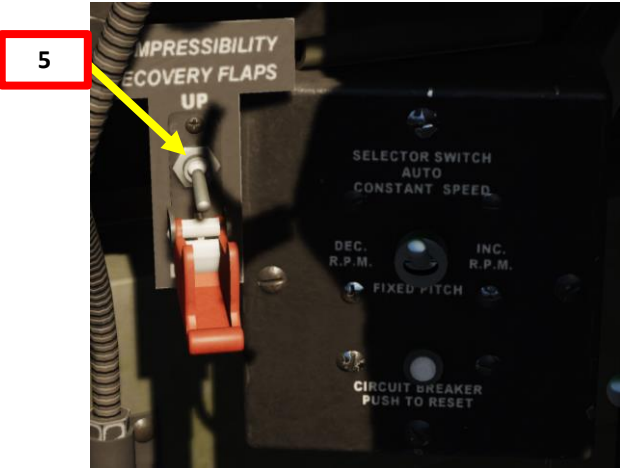

Gunsight Rheostat 2



Gun Safety Switch and Safety Guard (Red) 1



BOMBS (P-47D-30 EARLY SERIES)

6. There are many different bombing profiles, but typically I would recommend starting from 9000 ft above ground level with an airspeed of 250 mph IAS.
7. When you have the target in sight, roll in and reduce throttle to maintain a 45 to 60-degree dive with an airspeed between 350 and 420 mph. Do not arc over with low or negative G during the dive or the bomb could stick in the shackle or even hit the aircraft). The steeper the dive, the better your aiming will be.
8. Line up the target with the piper of the fixed sight.
 - *Note: Keep in mind that there are other available reference points/techniques to pull lead before dropping the bomb.*
9. You can use your slip ball below the gunsight to see if you are drifting left or right. Make sure you are not slipping when aiming for the target.
10. Using the sight piper generally means the bomb will fall short of the target; this means you need to add a little lead before releasing the bomb. Before releasing bombs, pull the nose slightly up. The target should be below the engine cowl flaps.
11. When you are 3000 ft above the target, pull the desired Bomb/Fuel Tank Jettison (Drop) Lever to release the bomb.
12. Apply full power and pull away from the blast.

The **Air Combat Tutorial Library** has a nice bombing video: https://youtu.be/HUs_BaX7Oa8

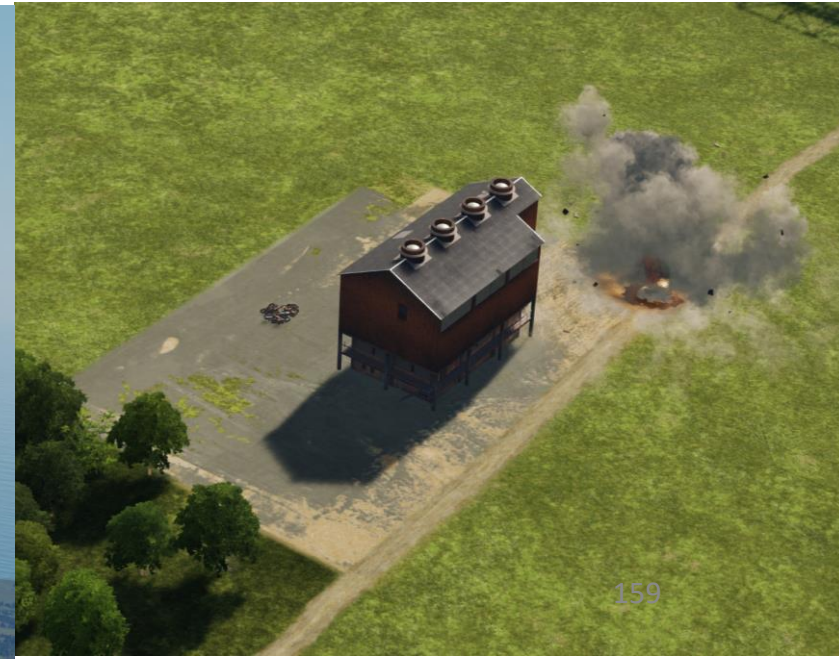
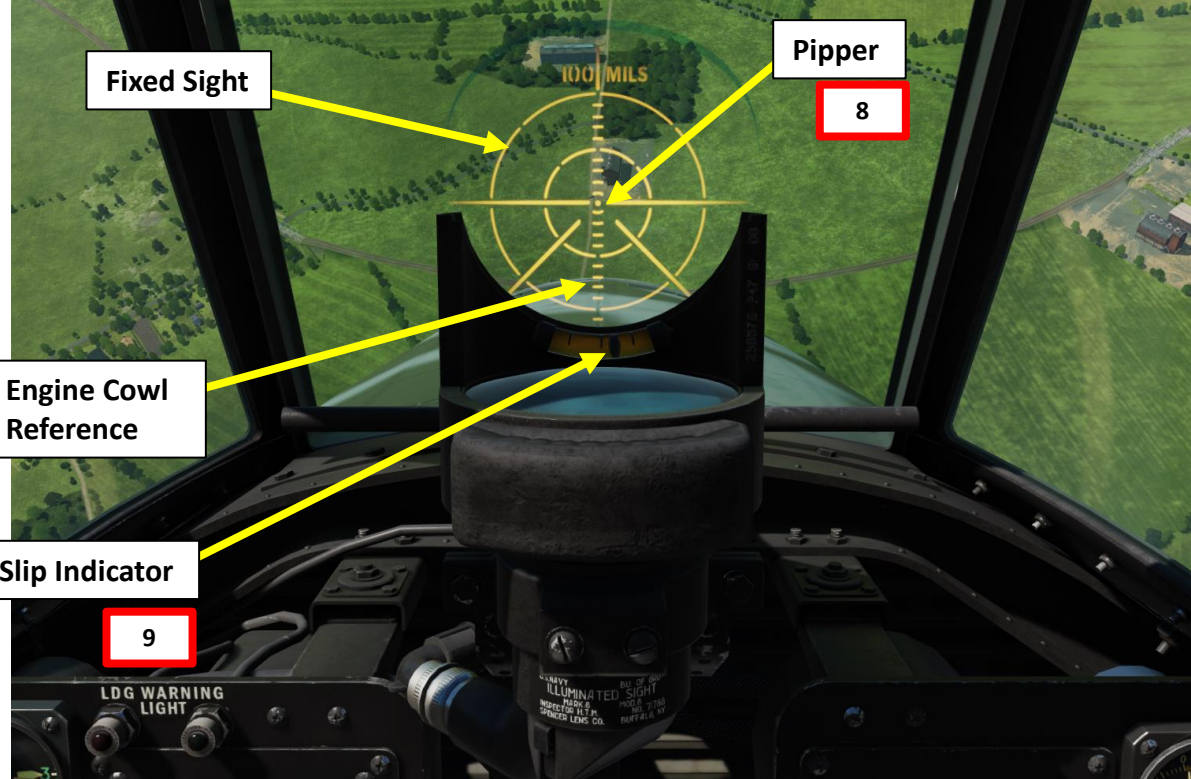

BOMBS (P-47D-30 LATE SERIES)

1. Flip Gun Safety Guard (Red) and set Gun Safety Switch DOWN (GUNS & CAMERA)
2. Rotate Gunsight Rheostat to ON
3. Set Gunsight Fixed Reticle Mask Lever UP (we want to display the fixed sight).
4. Close cowl flaps before diving
5. Select desired bomb by flipping the safety guard UP, then setting the arming switch UP.
6. Arm desired bomb by turning Counter-clockwise and pulling the arming lever, then turning it clockwise to arm.
7. This step is not mandatory, but I strongly recommend that you deploy the compressibility flaps to avoid overspeeding.

7

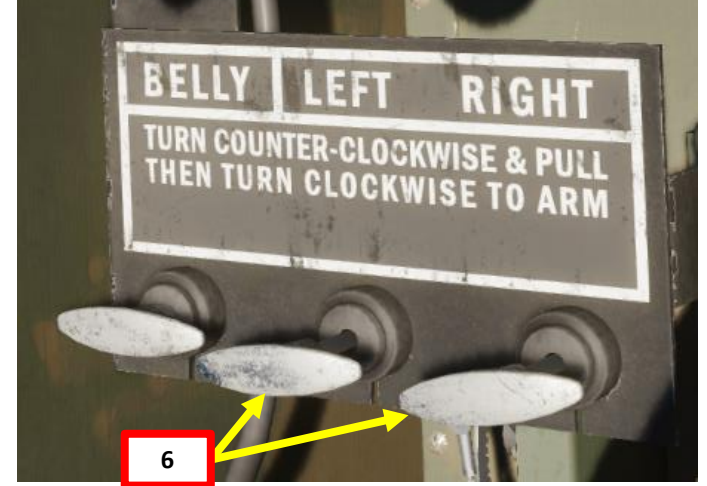

Gunsight Rheostat

2

3



Gun Safety Switch and Safety Guard (Red)

1

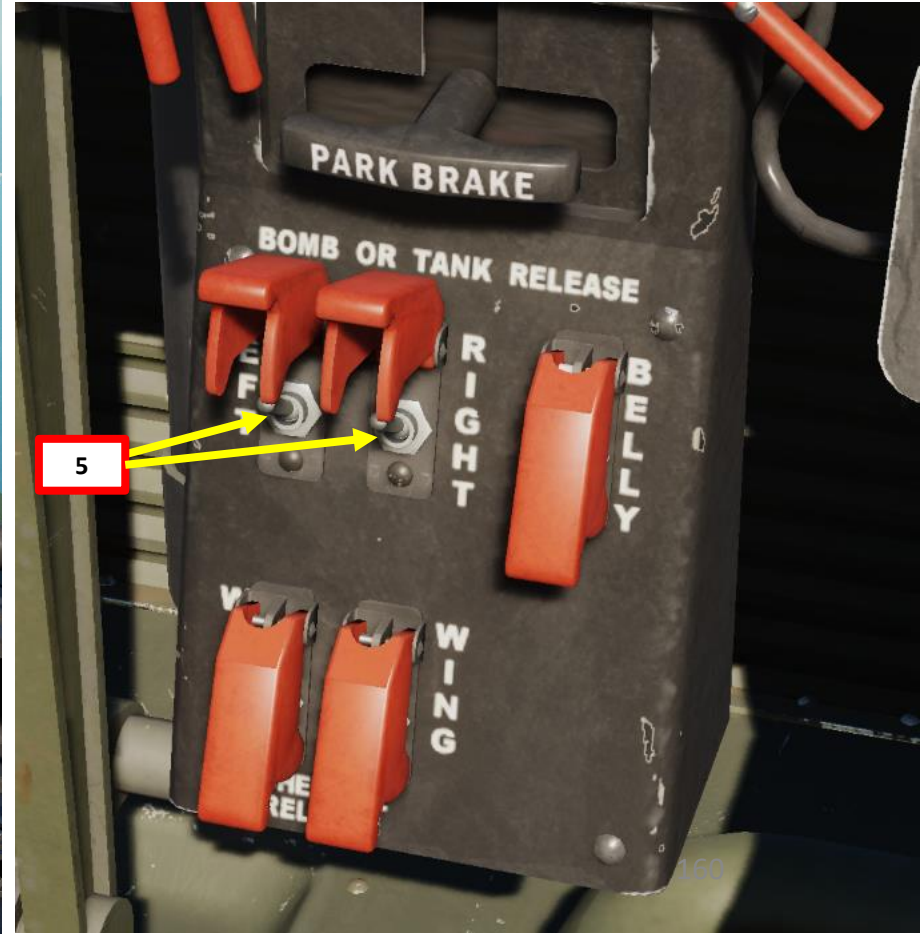

BOMBS (P-47D-30 LATE SERIES)

13

**Weapons (Bomb)
Release Button**

8. There are many different bombing profiles, but typically I would recommend starting from 9000 ft above ground level with an airspeed of 250 mph IAS.
9. When you have the target in sight, roll in and reduce throttle to maintain a 45 to 60-degree dive with an airspeed between 350 and 420 mph. Do not arc over with low or negative G during the dive or the bomb could stick in the shackle or even hit the aircraft). The steeper the dive, the better your aiming will be.
10. Line up the target with the "40 mils" line of the fixed sight.
 - *Note: Keep in mind that there are other available reference points/techniques to pull lead before dropping the bomb.*
11. You can use your gyro gunsight to see if you are drifting left or right. Make sure you are not slipping when aiming for the target.
12. Using the 40 mils line generally means the bomb will fall short of the target; this means you need to add a little lead before releasing the bomb. Before releasing bombs, pull the nose slightly up. The target should be below the engine cowl flaps.
13. When you are 3000 ft above the target, press the Weapons (Bomb) Release Button (RSHIFT+SPACE) to release the bomb.
14. Apply full power and pull away from the blast.

The **Air Combat Tutorial Library** has a nice bombing video: https://youtu.be/HUs_BaX7Oa8

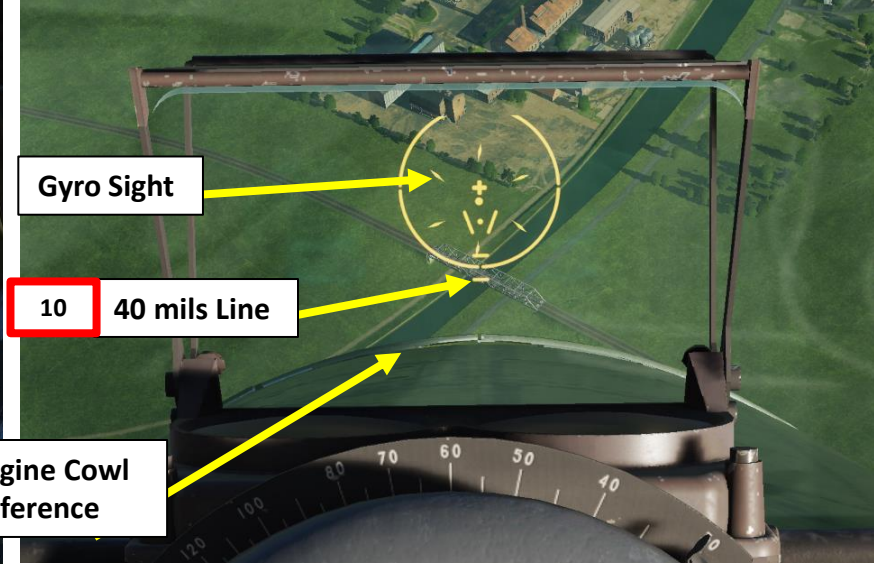
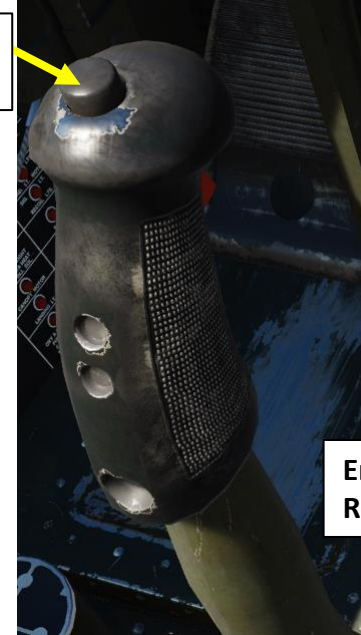

BOMBS (P-47D-40 SERIES)

1. Flip Gun Safety Guard (Red) and set Gun Safety Switch DOWN (GUNS & CAMERA)
2. Rotate Gunsight Rheostat to ON
3. Set Gunsight Fixed Reticle Mask Lever UP (we want to display the fixed sight).
4. Close cowl flaps before diving
5. Arm desired bomb by turning Counter-clockwise and pulling the arming lever, then turning it clockwise to arm.
6. Set Rockets / Bomb & Tank Selector Switch to BOMB & TANK (UP)
7. Set Arming Selector Switches to ARMED (UP) for the bombs you want to drop (Left Wing, Right Wing or Belly pylons)
8. Flip red safety guard, then set Bomb/Tank/Rocket Safety Switch to ARMED (UP)
9. This step is not mandatory, but I strongly recommend that you deploy the compressibility flaps to avoid overspeeding.

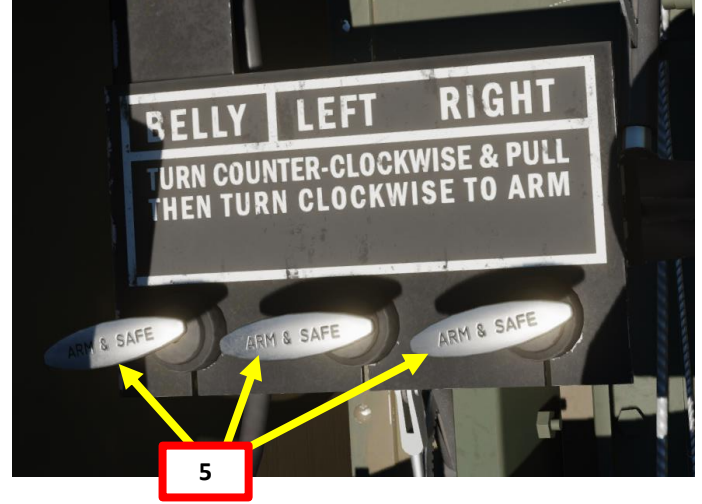
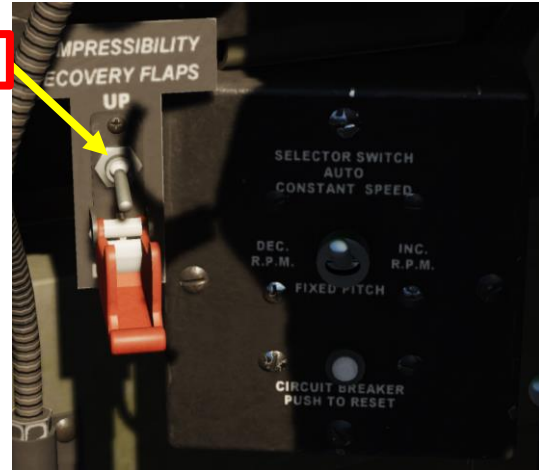

Gunsight Rheostat



Gun Safety Switch and Safety Guard (Red)

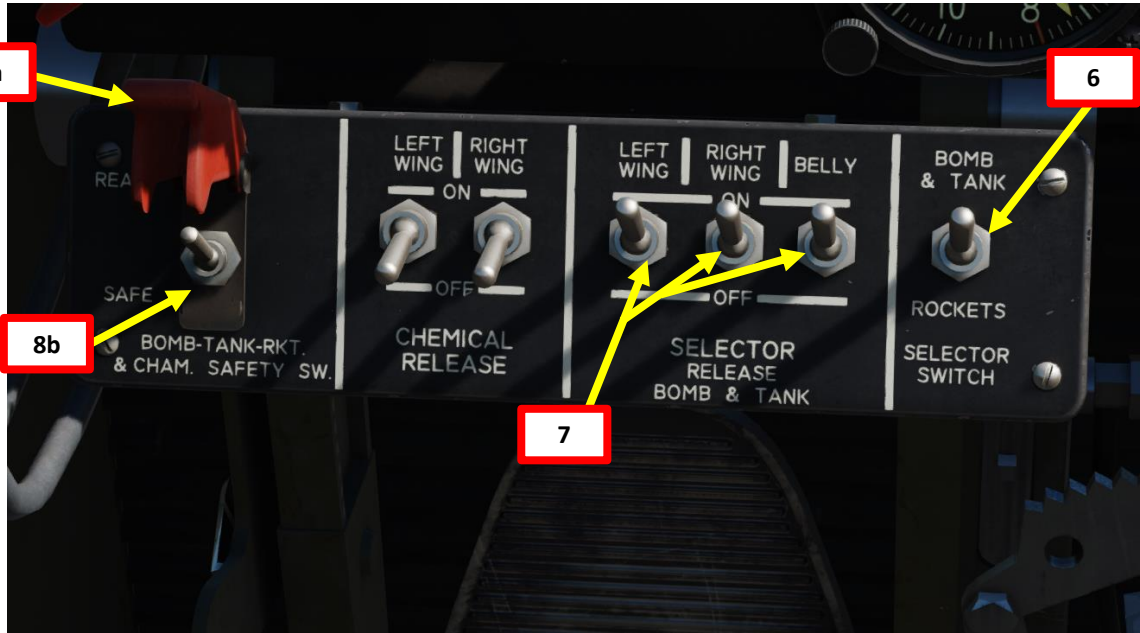

BOMBS (P-47D-40 SERIES)

10. There are many different bombing profiles, but typically I would recommend starting from 9000 ft above ground level with an airspeed of 250 mph IAS.
11. When you have the target in sight, roll in and reduce throttle to maintain a 45 to 60-degree dive with an airspeed between 350 and 420 mph. Do not arc over with low or negative G during the dive or the bomb could stick in the shackle or even hit the aircraft). The steeper the dive, the better your aiming will be.
12. Line up the target with the "40 mils" line of the fixed sight.
 - *Note: Keep in mind that there are other available reference points/techniques to pull lead before dropping the bomb.*
13. You can use your gyro gunsight to see if you are drifting left or right. Make sure you are not slipping when aiming for the target.
14. Using the 40 mils line generally means the bomb will fall short of the target; this means you need to add a little lead before releasing the bomb. Before releasing bombs, pull the nose slightly up. The target should be below the engine cowl flaps.
15. When you are 3000 ft above the target, press the Weapons (Bomb) Release Button (RSHIFT+SPACE) to release the bomb.
16. Apply full power and pull away from the blast.

15 Weapons (Bomb) Release Button

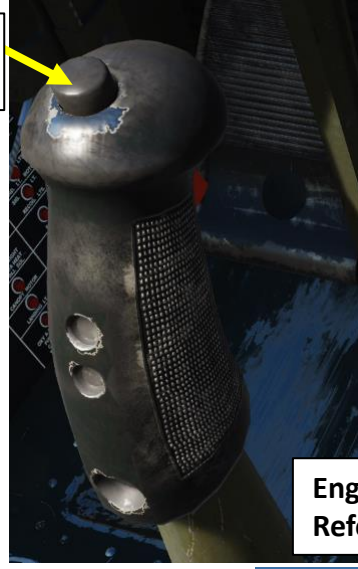

Gyro Sight

12 40 mils Line

Engine Cowl Reference

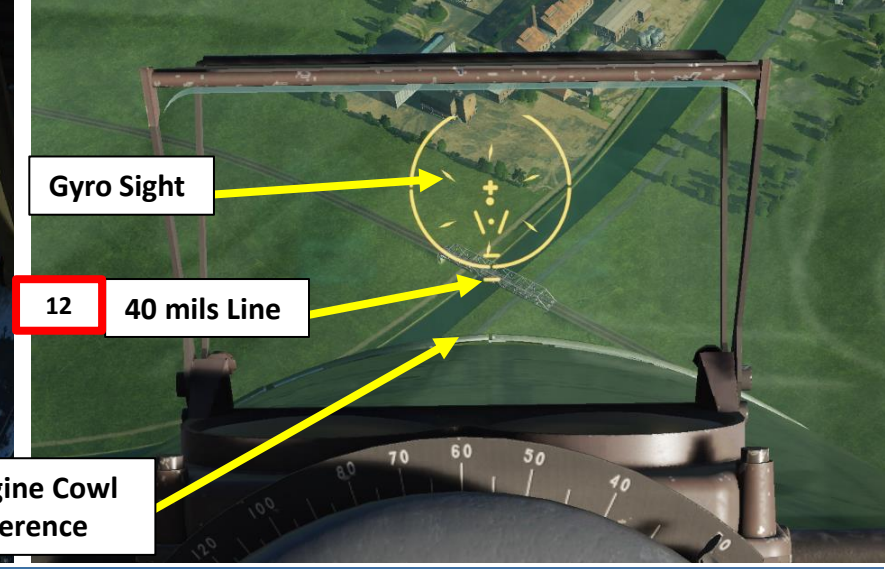

The Air Combat Tutorial Library has a nice bombing video: https://youtu.be/HUs_BaX7Oa8



ROCKETS (P-47D-40 SERIES)

1. Flip Gun Safety Guard (Red) and set Gun Safety Switch DOWN (GUNS & CAMERA)
2. Rotate Gunsight Rheostat to ON
3. Set Gunsight Fixed Reticle Mask Lever UP (we want to display the fixed sight).
4. Set Rockets / Bomb & Tank Selector Switch to ROCKETS (DOWN)
5. Flip red safety guard, then set Bomb/Tank/Rocket Safety Switch to ARMED (UP)



Gunsight Rheostat

2



Gun Safety Switch and Safety Guard (Red)

1

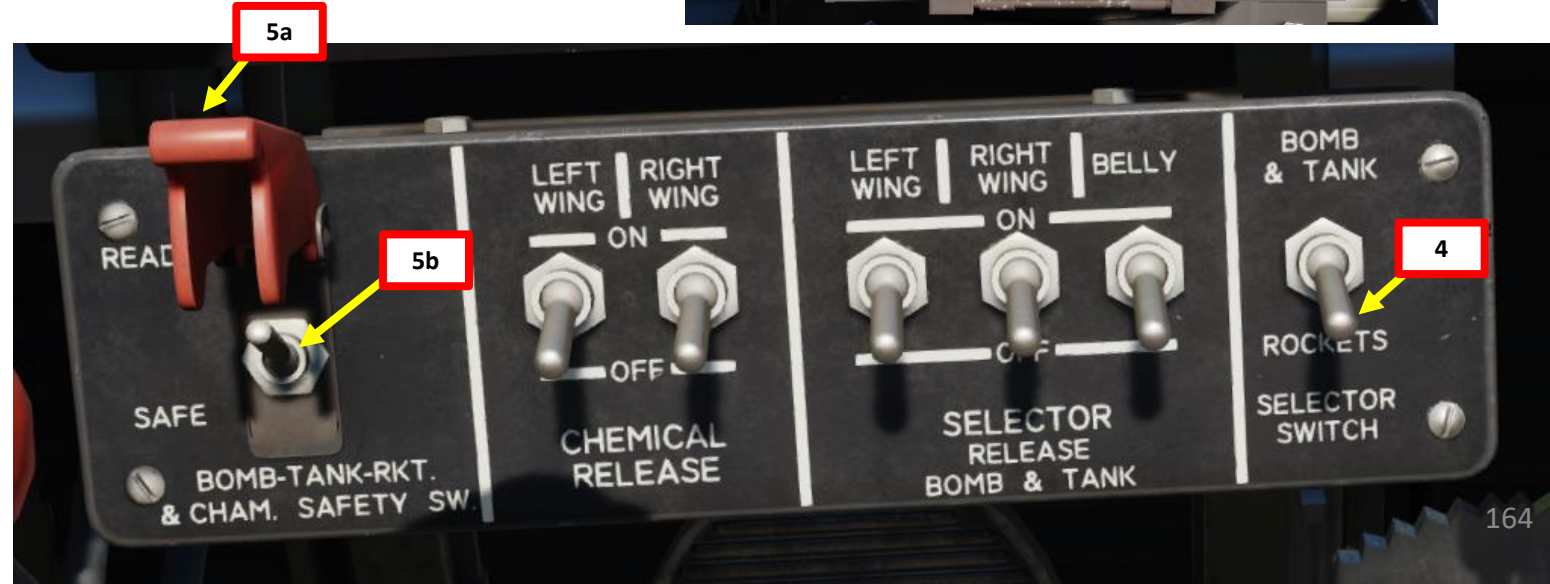

5a

5b

4

3



ROCKETS (P-47D-40 SERIES)

6. Select desired rocket firing mode
 - a) Single = Fires 1 Rocket
 - b) Auto = Fires Multiple Rockets as long as Weapon Release button is pressed.
7. Set rocket counter if Auto Firing Mode is selected (should be set to 1 at start of a mission)
8. Select desired Rocket Salvo Size
 - a) Handle DOWN sets DUAL Salvo: rockets are fired from each wing
 - b) Handle UP sets ALTERNATE Salvo: rockets are fired from one wing only
9. Select rocket fuze delay (Delay or Instantaneous)

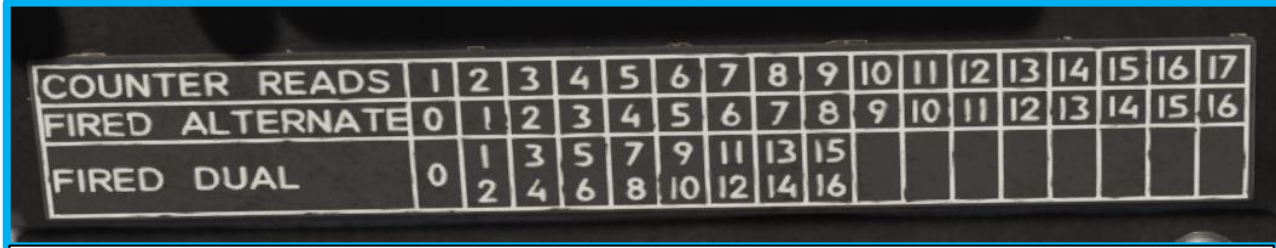

How to read the Rocket Counter

The Rocket Counter window indicates the next rocket to be fired according to station number. The knob of the Rocket Control Counter panel is used to set the desired rocket station for fire. This should be set to 1 at the start of a mission.

Rocket Salvo Size Selector

- Handle Pointed UP (ALTERNATE) – Upon Weapon Release button press, a single rocket can be fired
- Handle Pointed DOWN (DUAL) – Upon Weapon Release button press, rockets are fired from both wings in order to maintain aircraft roll stability

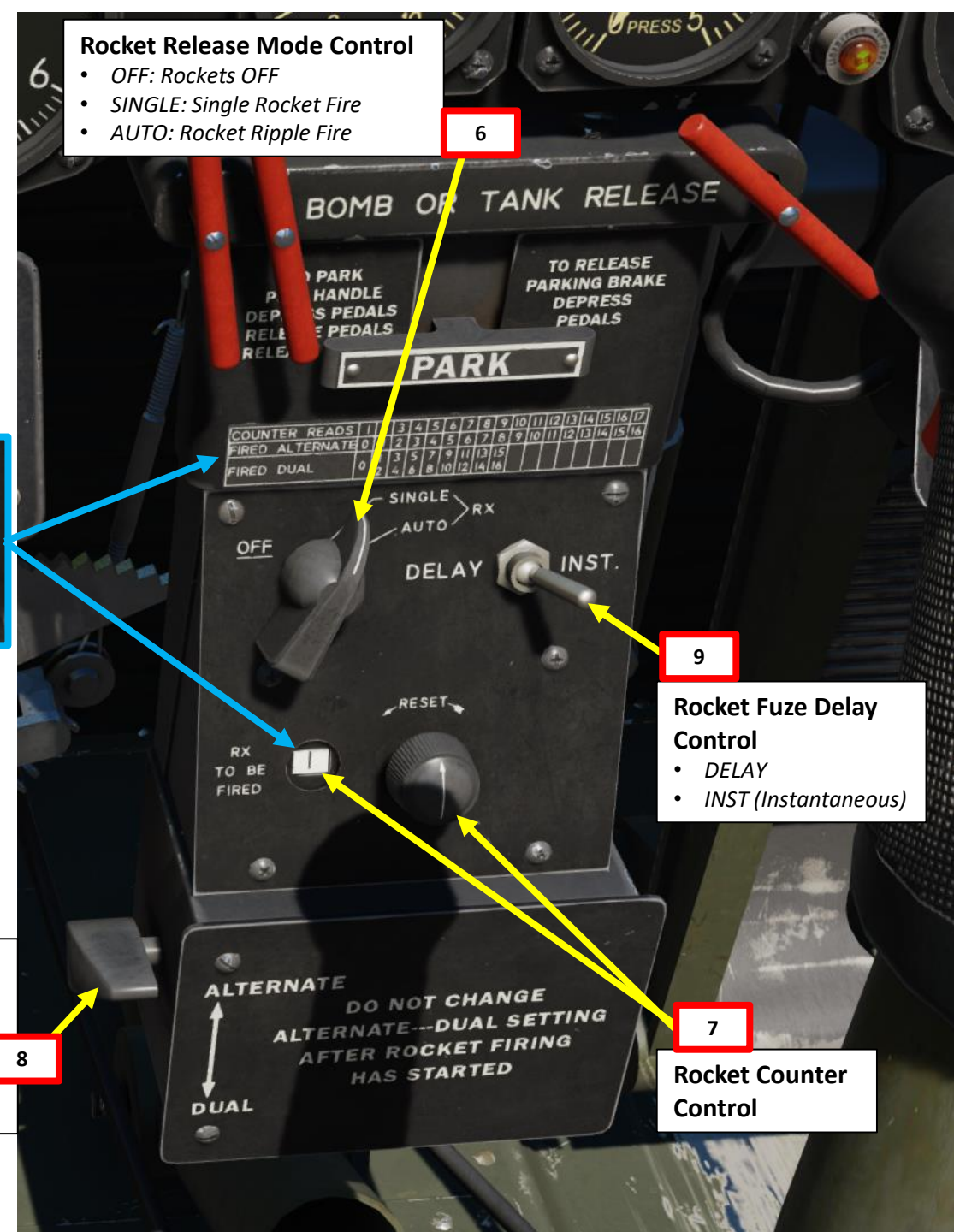

Rocket Release Mode Control

- OFF: Rockets OFF
- SINGLE: Single Rocket Fire
- AUTO: Rocket Ripple Fire

6

9

Rocket Fuze Delay Control

- DELAY
- INST (Instantaneous)

7

Rocket Counter Control

8

ROCKETS (P-47D-40 SERIES)

10. There are many different attack profiles, but typically I would recommend starting from 1500-2000 ft above ground level.
11. When you have the target in sight, roll in and reduce throttle to maintain a 15 to 20-degree dive with an airspeed between 350 and 420 mph.
12. Line up the target with center cross of the fixed sight.
 - *Note: Keep in mind that there are other available reference points/techniques to pull lead before launching the rocket.*
13. You can use your gyro gunsight to see if you are drifting left or right. Make sure you are not slipping when aiming for the target.
14. When you are 1000 ft away from the target, press the Weapons (Bomb/Rocket) Release Button (RSHIFT+SPACE) to fire rocket(s).
15. Apply full power and pull away from the blast. Recovery altitude should be about 75 ft above ground level.

14

Weapons (Bomb) Release Button

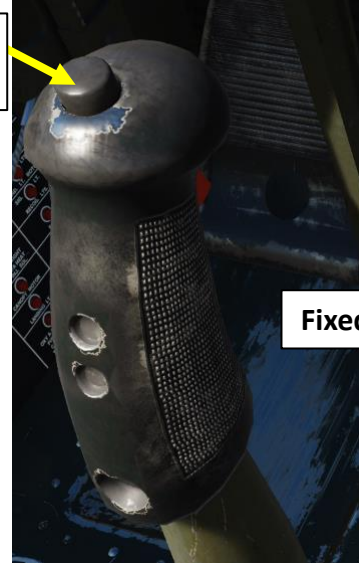

12

Gyro Sight

Fixed Sight Center Cross

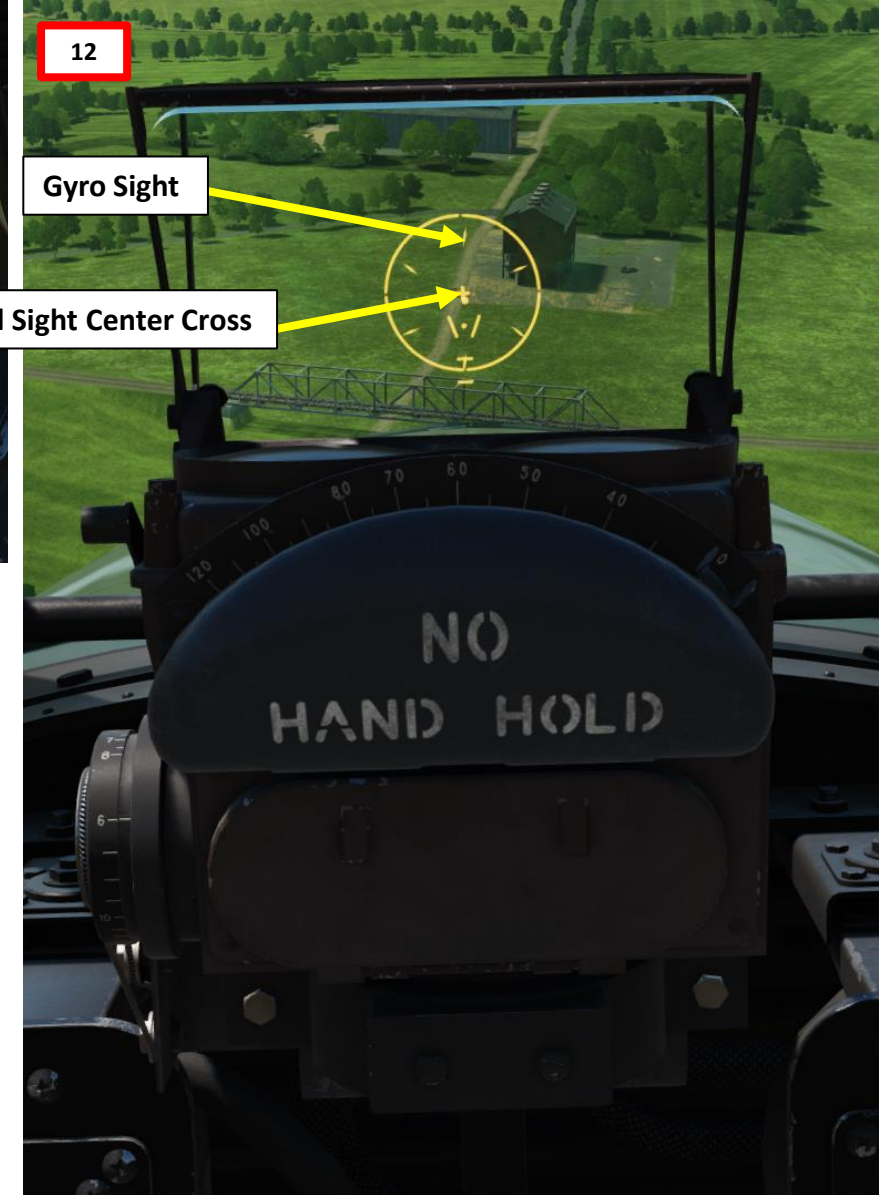

The Air Combat Tutorial Library has a nice rocket video: <https://youtu.be/dhEsT59b1Fo>





P-47D
THUNDERBOLT

ROCKETS (P-47D-40 SERIES)



PART 9 - WEAPONS

RADIO FREQUENCY RANGE: 100 - 156 MHz

SCR-522-A VHF RADIO

The P-47D is equipped with a SCR-522 VHF (Very High Frequency) radio system. Radio frequencies are preset in the mission editor for 4 different channels and cannot be changed manually during flight.

1. Set the radio Transmit-Receive switch to "REM" (Remote Operation, RIGHT position)
2. Set Radio Volume by turning the Volume Control Knob
3. Select desired channel (A, B, C or D)
4. Press the Push-to-Talk switch on your throttle to transmit ("COMM PUSH TO TALK" control, or "RALT+\")

Radio Mode Switch

- LEFT: T (transmit)
- MIDDLE: R (receive)
- RIGHT: REM (remote operation)

1

Radio Channel Lights (A, B, C, D)

Radio Lights Dimmer

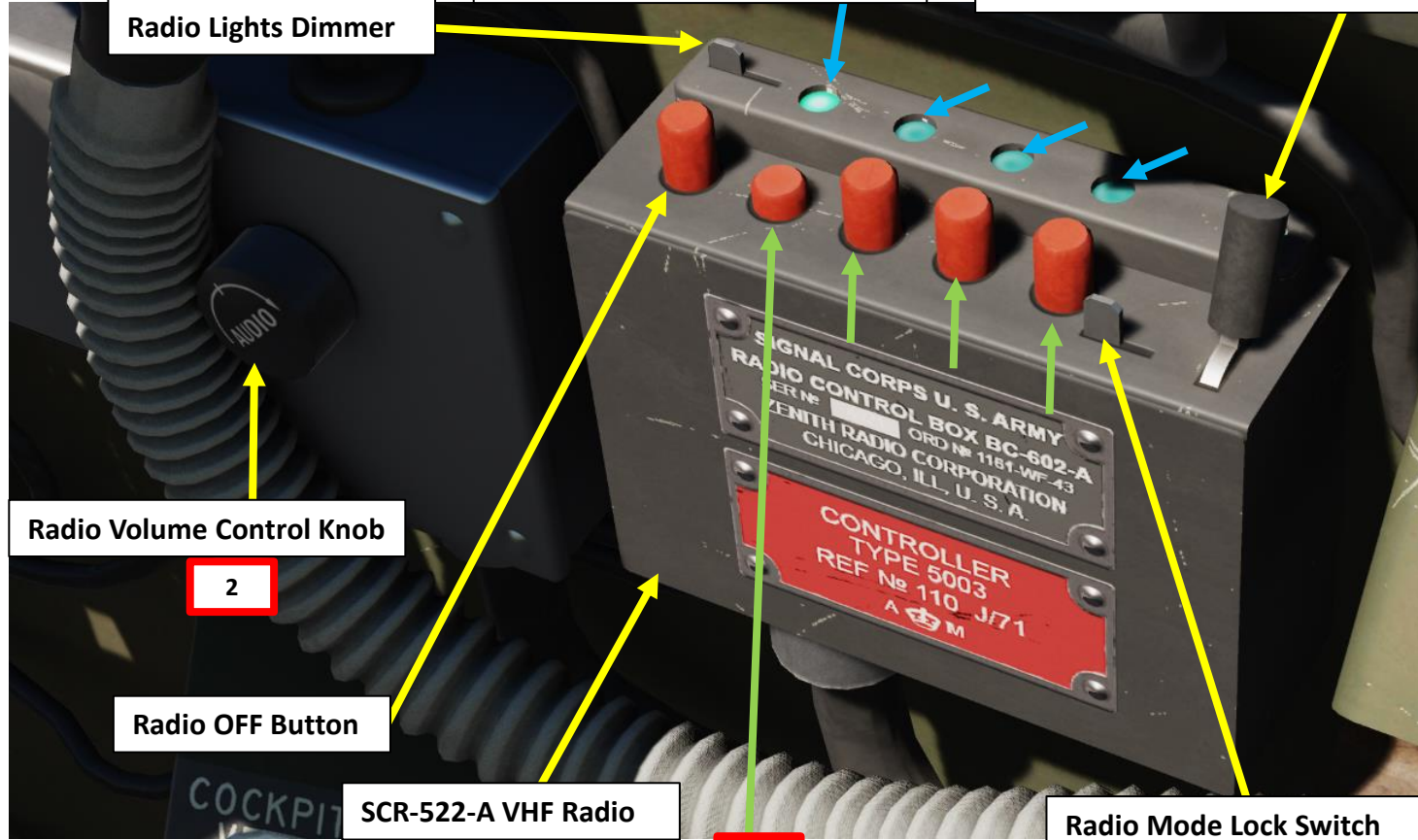

Radio Volume Control Knob

2

Radio OFF Button

SCR-522-A VHF Radio

3

Radio Mode Lock Switch

Radio Channel Selector Buttons (A, B, C, D)

P-47D-30 Late & D-40 Variants

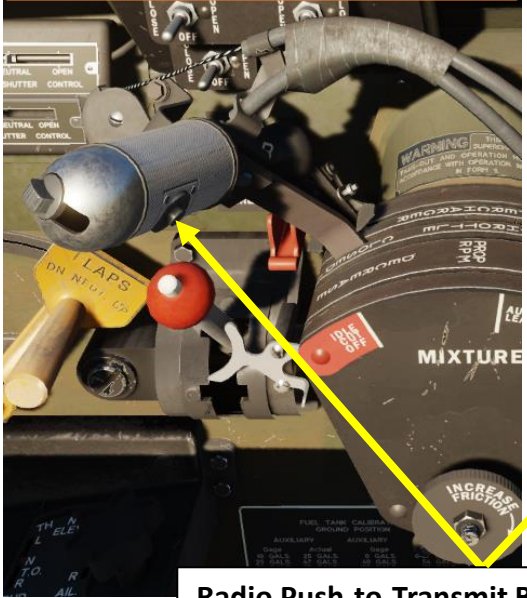

Radio Push-to-Transmit Button

4

P-47D-30 Early Variant

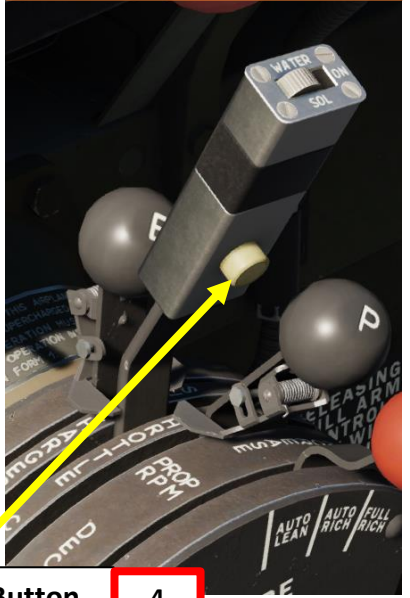

OPTIONS			
SYSTEM	CONTROLS	GAMEPLAY	MISC. AUDIO
P-47D-30 Sim	All	<input checked="" type="checkbox"/> Foldable view	Reset category to default Clear category
Action	Category	Keyboard	Throttle - HOTAS...
COMM Push to talk	Communications	RAlt + \	JOY_BTN4
Cockpit and Light and Instrumentation Circuit Breaker RESET	Main Switch Box		

AIRPLANE GROUP
✕

NAME ?

CONDITION % < >

COUNTRY ● USA

TASK ▾

UNIT OF

TYPE ▾

SKILL ▾

PILOT

TAIL #

RADIO FREQUENCY MHz ▾

CALLSIGN ▾

HIDDEN ON MAP

HIDDEN ON PLANNER

LATE ACTIVATION

📶
📶
📶
Σ
🚫
📶

SCR522

ButtonA	<input type="text" value="124"/>	MHz	AM
ButtonB	<input type="text" value="125"/>	MHz	AM
ButtonC	<input type="text" value="126"/>	MHz	AM
ButtonD	<input type="text" value="127"/>	MHz	AM

RADIO FREQUENCIES – AIRFIELDS

LOCATION	FREQUENCY (MHz)
Anapa	121.0
Batumi	131.0
Beslan	141.0
Gelendzhik	126.0
Gudauta	130.0
Kobuleti	133.0
Kutaisi	134.0
Krasnodar Center	122.0
Krasnodar Pashkovsky	128.0
Krymsk	124.0
Maykop	125.0
Mineral'nye Vody	135.0
Mozdok	137.0
Nalchik	136.0
Novorossiysk	123.0
Senaki	132.0
Sochi	127.0
Soganlug	139.0
Sukhumi	129.0
Tblisi	138.0
Vaziani	140.0

**Channel A:**

- Plane-to-plane communication on local flights
- Communication with controller in your own region.

Channel B:

- Common to all VHF-equipped control towers. It is normally used to contact the control tower for takeoff and landing instructions

Channel C:

- Frequently used in contacting homing stations

Channel D:

- Plane-to-plane contact between a pilot practicing fighter instrument flying and his safety pilot.
- Normally used for plane-to-ground contact with D/F (Directional Finding) stations. The pip-squeak (contactor), used in conjunction with the D/F fixing provides controllers and intercepts officers with an accurate minute-by-minute position report of your plane. The contactor clock consists of a dial and two switches.

NAVIGATION INSTRUMENTS

Most of the navigation must be done visually in the Thunderbolt. Consult the Gyro and Magnetic Compass to determine your current magnetic heading.

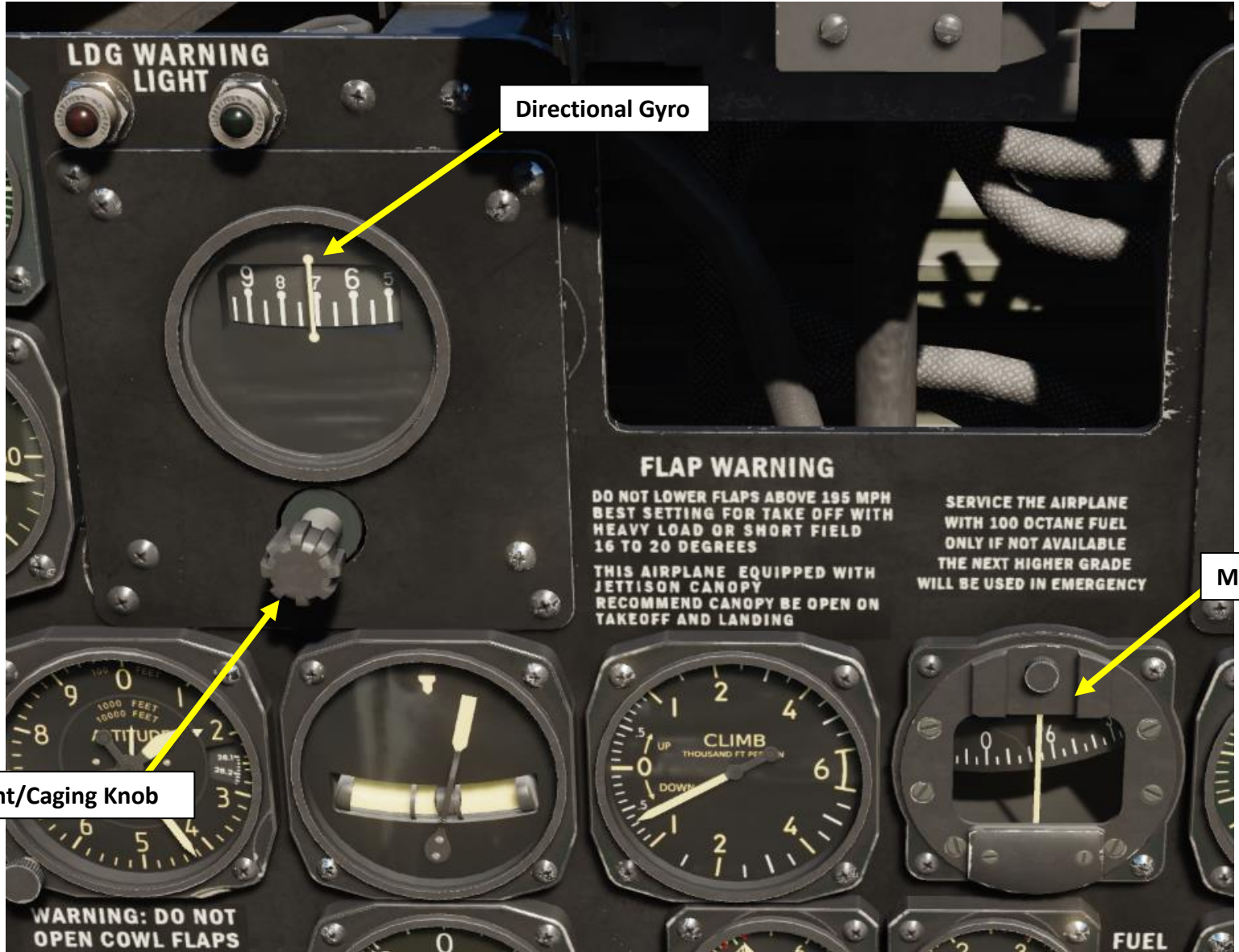

Directional Gyro

Magnetic Compass

Directional Gyro Adjustment/Caging Knob

MAGNETIC DECLINATION

The direction in which a compass needle points is known as magnetic north. In general, this is not exactly the direction of the North Magnetic Pole (or of any other consistent location). Instead, the compass aligns itself to the local geomagnetic field, which varies in a complex manner over the Earth's surface, as well as over time. The local angular difference between magnetic north and true north is called the magnetic declination. Most **map coordinate** systems are based on **true north**, and magnetic declination is often shown on map legends so that the direction of true north can be determined from north as indicated by a compass. This is the reason why in DCS, the course to a runway needs to be “adjusted” to take into account this magnetic declination of the magnetic North pole (which is actually modelled in the sim, which is pretty neat).

True Heading = Magnetic Heading + Magnetic Deviation

As an example, if the runway heading that you read on the F10 map in Azeville is 071 (True Heading), then the direction you should take with your magnetic compass course should be 071 subtracted with the Magnetic Deviation (-11 degrees), or 082. In other words, you would need to use a course of 082 (M) with your compass.

Magnetic Declination:

- 11 deg for Normandy in 1944
- 11 deg for the English Channel in 1944

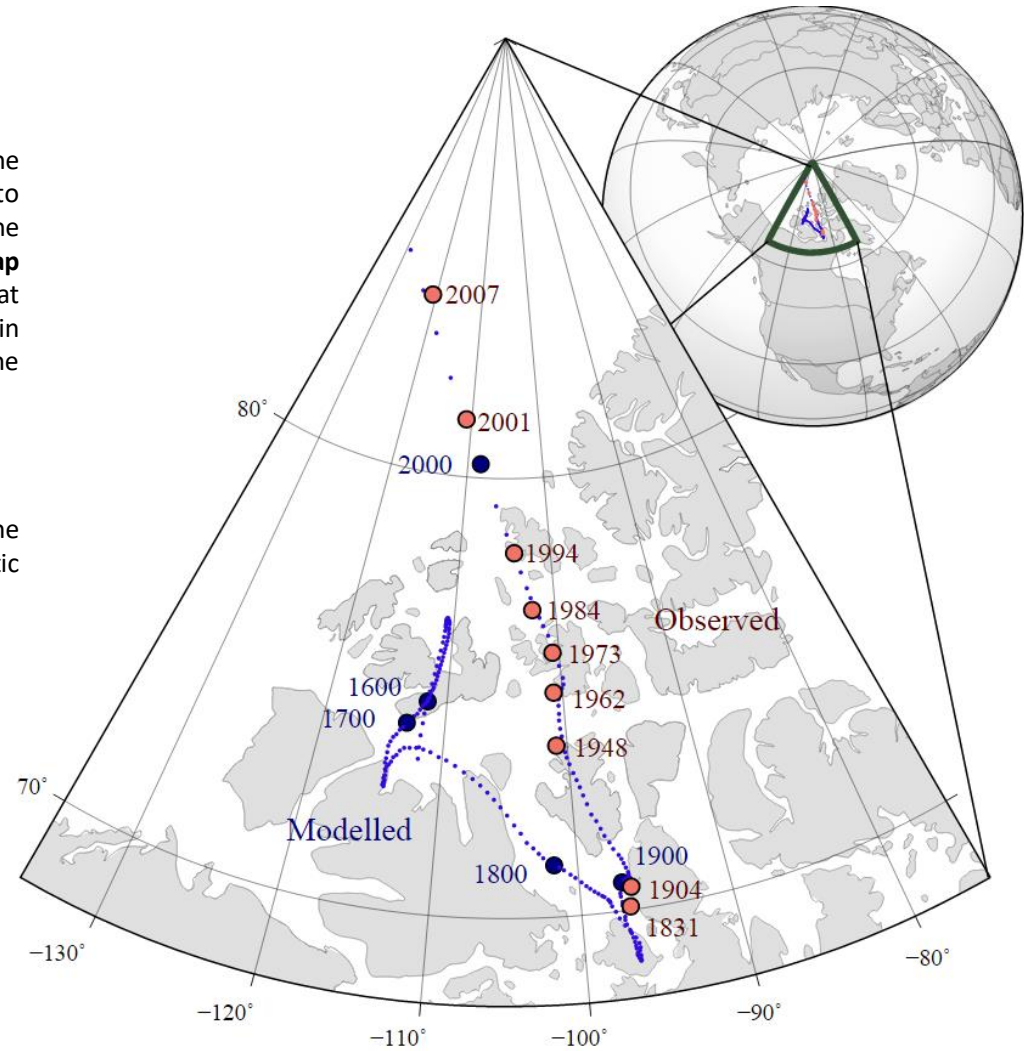

The movement of Earth's north magnetic pole across the Canadian arctic, 1831–2007.

Azeville	
ICAO	A-7
COALITION	RED
ELEVATION	74 ft
RWY Length	3549 ft
COORDINATES	49°28'46"N 01°19'29"W
TACAN	--
VOR	--
RSBN	--
ATC (MHz, AM)	3.925, 38.800, 118.350, 250.350
RWYs	7 25
ILS	-- --
PRMG	-- --
OUTER NDB	-- --
INNER NDB	-- --
RESOURCES	

MAGNETIC DECLINATION

Checking the magnetic declination is now very easy: you can access it directly from the F10 map, shown with the Compass Rose.

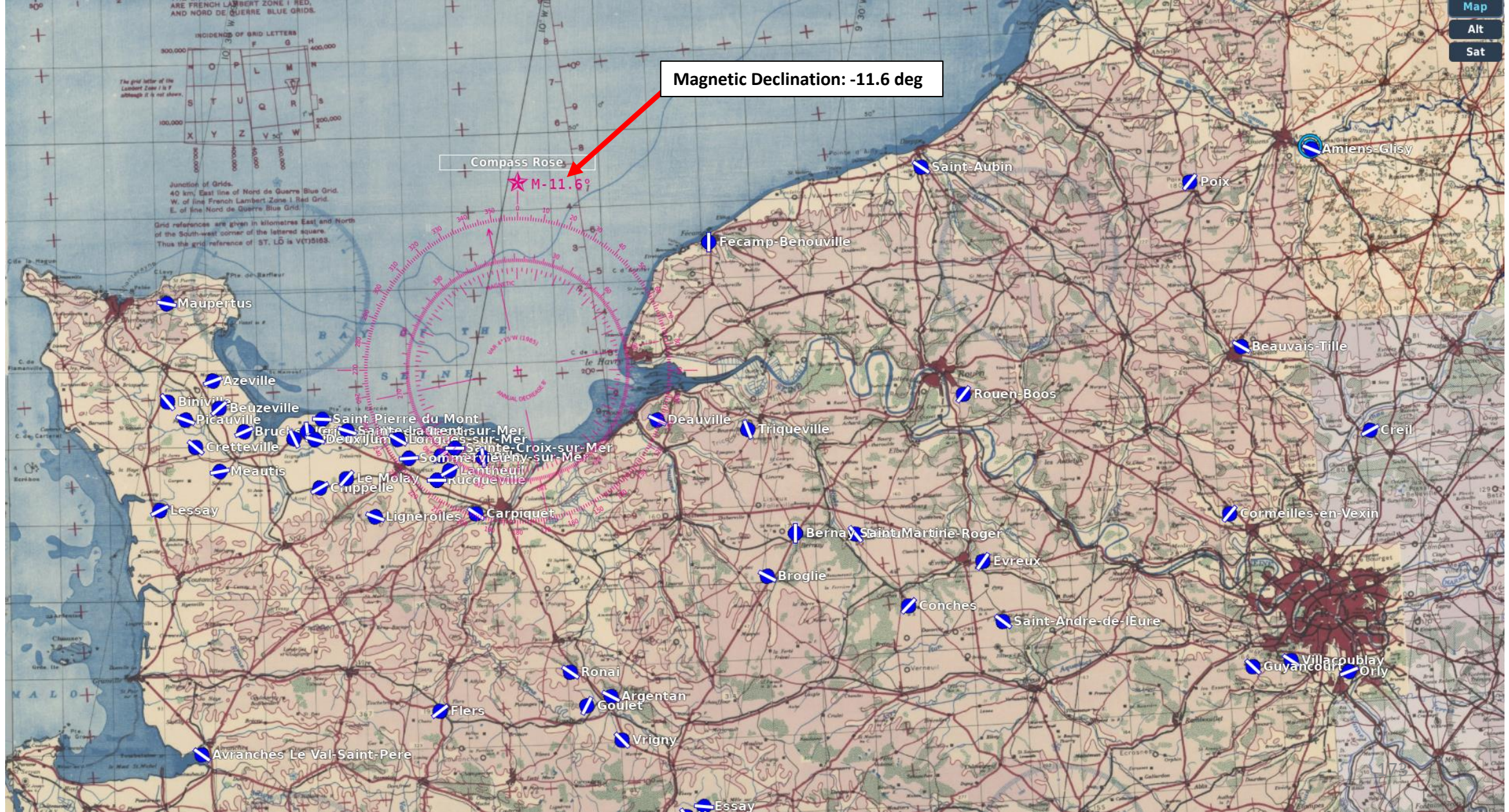

AIRPORT DATA

NORMANDY

1944

By Minsky
<https://www.digitalcombatsimulat or.com/en/files/3312200/>

AD Normandy 2.0, Part 1 Average magvar: -9° (1944) / +1° (2023) **DimOn**

ID	UK England	ELEV. FEET METERS	VHF UHF	HF FM	MAG HDG / 3500 ft (1000m) OR LESS DOT - PRIMARY / LENGTH, feet / GRASS RWY	
71	Biggin Hill N51°19'38/.646 E00°01'57/.954	568 173	134.80 253.45	5.475 41.85	BROKEN SPAWNS	033° XX 4800 XX 213° 053° XX 2500 XX 233° 113° XX 2800 XX 293°
27	Chailey N50°57'08/.149 W00°02'50/.844	95 29	119.15 251.05	4.275 39.50		082° 07 4200 25 262° 161° ·15 3500 33·341°
54	Deanland N50°53'03/.059 E00°09'40/.680	72 22	120.60 252.50	5.000 40.95	RWY 34: HUGE BUMP	063° 22 3800 34 243°
73	Detling N51°18'20/.346 E00°36'05/.092	593 181	118.45 253.55	5.525 41.95		051° 04 3700 22 231°
52	Farnborough N51°16'43/.722 W00°46'28/.480	246 75	120.50 252.40	4.950 40.85	17 06	071° 06 4700 24 251° 116° 10 3000 28 296° 182° ·17 4000 35·002°
31	Ford N50°49'05/.085 W00°35'26/.443	29 9	119.40 251.30	4.400 39.75		067° 05 5600 23 247° 153° ·14 4500 32·333°
53	Friston N50°45'42/.704 E00°10'17/.289	309 94	120.55 252.45	4.975 40.90		069° 06 3700 24 249°
29	Funtington N50°52'05/.088 W00°52'08/.144	125 38	119.25 251.15	4.325 39.60		095° 08 6700 26 275° 160° ·15 5000 33·340°
66	Gravesend N51°25'04/.079 E00°23'48/.802	232 71	121.25 253.15	5.325 41.55	UNEVEN	187° 18 5000 36 007°
50	Heathrow N51°28'39/.657 W00°27'12/.216	89 27	CLOSED, NO ATC			098° 12 8700 30 278°
43	Kenley N51°18'14/.240 W00°05'47/.794	561 171	120.05 251.95	4.725 40.40	RWY 30: NO LAND	031° 02 3000 20 211° 131° ·02 2100 30·311°
37	Lymington N50°45'44/.748 W01°30'51/.863	20 6	119.70 251.60	4.550 40.05		068° 06 4200 24 248° 147° ·12 3500 30·327°
74	Lympne N51°04'58/.969 E01°01'10/.178	225 68	NO ATC			028° 02 3500 20 208° 119° ·07 3000 25·290°
72	Manston N51°20'32/.539 E01°20'46/.769	157 48	118.25 253.50	5.500 41.90		060° 05 5000 23 240° 107° ·XX 8700 XX·287°
28	Needs Oar Point N50°46'17/.299 W01°26'04/.071	20 6	119.20 251.10	4.300 39.55		071° ·06 4200 24·251° 180° 17 4700 35 000°
39	Odiham N51°14'03/.065 W00°56'30/.504	366 112	119.80 251.70	4.600 40.15		105° 10 5100 28 285°
58	Stoney Cross N50°54'40/.667 W01°39'29/.486	384 117	120.80 252.70	5.100 41.15		073° ·06 5800 24·253° 192° 18 4800 36 012°
30	Tangmere N50°50'44/.744 W00°42'06/.113	48 15	119.35 251.25	4.375 39.70		072° 06 5700 24 252° 162° ·03 4400 21·332°
41	West Malling N51°16'13/.221 E00°24'16/.281	305 93	119.95 251.85	4.675 40.30		074° ·15 5700 33 254°

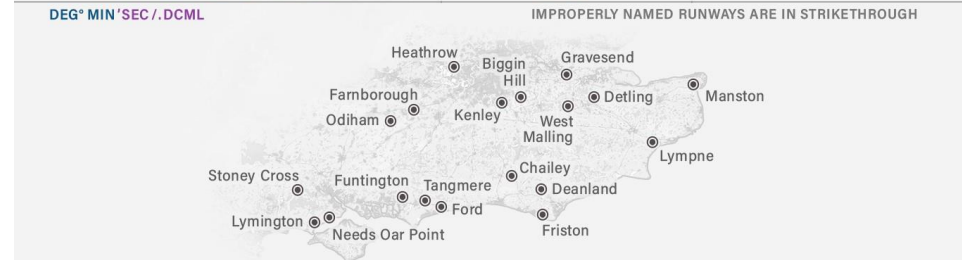

Adjust the above magnetic headings when flying in the following years (expect 1-2 degrees of error):
 1935-1941 +1° 1951-1959 -1° 1960-1971 -2° 1972-1979 -3° 1980-1985 -4° 1986-1995 -5°
 1996-2001 -6° 2002-2009 -7° 2010-2016 -8° 2017-2020 -9° 2021-2026 -10°

AD Normandy 2.0, Part 2 Average magvar: -9° (1944) / +1° (2023) **DimOn**

ID	FR France A-Deauv	ELEV. FEET METERS	VHF UHF	HF FM	MAG HDG / 3500 ft (1000m) OR LESS DOT - PRIMARY / LENGTH, feet / GRASS RWY	
75	Abbeville Druacat N50°08'16/.274 E01°50'17/.295	217 66	121.55 253.60	5.550 42.00		027° 02 5000 20 207° 093° 09 5000 27 273° 135° ·13 5200 31·315°
59	Amiens-Glisys N49°52'17/.290 E02°23'30/.513	216 66	120.85 252.75	5.125 38.40		049° 04 5100 22 229° 120° ·11 5100 29·300°
32	Argentan N48°46'07/.126 W00°01'49/.826	640 195	119.45 251.35	4.425 39.80		127° 12 3800 30 307°
65	Avranches Le Val-Saint-Pere N48°40'05/.091 W01°22'50/.837	47 14	121.20 253.10	5.300 41.50		137° 13 3800 31 317°
15	Azeville A-7 N49°28'51/.859 W01°19'03/.057	75 23	118.50 250.40	3.950 38.85		080° 07 3600 25 260°
34	Barville N48°28'48/.807 E00°18'50/.837	463 141	119.55 251.45	4.475 39.90		105° 10 4000 28 285° 156° ·15 4100 33·336°
20	Bazenville B-2 N49°18'14/.236 W00°33'53/.884	200 61	118.80 250.70	4.100 39.15		063° 05 5400 23 243°
67	Beaumont-le-Roger N49°05'46/.780 E00°47'48/.814	489 149	121.30 253.20	5.350 41.60		060° 04 2900 22 240° 092° 07 2400 25 272° 150° ·13 2600 31·330°
44	Beauvais-Tille N49°27'14/.249 E02°06'47/.792	331 101	120.10 252.00	4.750 40.45		046° 04 5500 22 226° 128° ·12 5300 30·308°
21	Beny-sur-Mer B-4 N49°17'52/.878 W00°25'35/.597	199 61	118.90 250.80	4.150 39.25		181° 17 4200 35 001°
69	Bernay Saint Martin N49°06'15/.264 E00°35'54/.905	512 156	121.40 253.30	5.400 41.70	MESH ISSUES	189° 18 3500 36 009°
14	Beuzeville A-6 N49°25'13/.231 W01°17'54/.913	114 35	118.40 250.35	3.925 38.80		059° 05 4300 23 239°
10	Binville A-24 N49°26'12/.202 W01°28'08/.138	107 32	118.15 250.15	3.825 38.60		150° 14 3500 32 330°
68	Broglie N49°00'56/.939 E00°29'55/.932	595 181	121.35 253.25	5.375 41.65		127° 12 3700 30 307°
5	Brucheville A-16 N49°22'06/.111 W01°12'58/.976	46 14	120.90 252.80	5.150 41.20		076° 07 4800 28 256°
19	Carpiquet B-17 N49°10'30/.507 W00°27'16/.268	187 57	118.70 250.60	4.050 39.05		133° 12 5100 30 313°
11	Cardonville A-3 N49°21'03/.060 W01°03'03/.060	102 31	118.20 250.20	3.850 38.65		164° 15 4800 33 344°
13	Chippelle A-5 N49°14'30/.513 W00°58'17/.299	125 38	118.35 250.30	3.900 38.75		070° 06 4900 24 250°
40	Conches N48°56'05/.086 E00°57'40/.676	541 165	119.90 251.80	4.650 40.25		052° 04 5100 22 232°
45	Cormeilles-en-Vexin N49°05'35/.594 E02°02'07/.124	312 95	120.15 252.05	4.775 40.50		048° ·04 5300 22·228° 122° 11 5200 29 302°
46	Creil N49°15'12/.208 E02°31'08/.136	269 82	120.20 252.10	4.800 40.55		069° ·15 7600 33·249° 138° 13 4000 31 318°
3	Cretteville A-14 N49°20'11/.194 W01°22'45/.761	95 29	119.85 251.75	4.625 40.20		140° 13 4800 31 320°
7	Cricqueville-en-Bessin A-2 N49°21'52/.872 W01°00'24/.414	81 25	121.70 253.75	5.625 42.15		183° 17 4900 35 003°
62	Deauville N49°21'51/.855 E00°09'26/.434	459 140	121.05 252.95	5.225 41.35	DAMAGED, LANDABLE	125° 12 3500 30 305°

Adjust the above magnetic headings when flying in the following years (expect 1-2 degrees of error):
 1935-1941 +1° 1951-1959 -1° 1960-1971 -2° 1972-1979 -3° 1980-1985 -4° 1986-1995 -5°
 1996-2001 -6° 2002-2009 -7° 2010-2016 -8° 2017-2020 -9° 2021-2026 -10°

AIRPORT DATA

NORMANDY

1944

By Minsky
<https://www.digitalcombatsimulat or.com/en/files/3312200/>

AD Normandy 2.0, Part 3

Average magvar: -9° (1944) / +1° (2023)
 The magnetic headings below are valid from 1942 to 1950

DimOn

ID	France	ELEV. FEET METERS	VHF HF UHF FM	MAG HDG / 3500 ft (1000m) OR LESS DOT - PRIMARY / LENGTH, feet / GRASS RWY	
12	Deux Jumeaux A-4 N49°20'50/.838 W00°58'50/.849	124 38	118.30 3.875 250.25 38.70	115° 10 4800 28 295°	—
49	Dinan-Trelivan N48°26'36/.602 W02°06'11/.187	377 115	120.35 4.875 252.25 40.70	081° 07 2800 25 261°	—
35	Essay N48°31'14/.235 E00°15'27/.461	507 155	119.60 4.500 251.50 39.95	104° 09 3500 27 284°	—
26	Evreux N49°01'25/.426 E01°12'47/.789	423 129	119.10 4.250 251.00 39.45	044°·21 4800 35·224° 173° 16 5000 34 353°	X
51	Fecamp-Benouville N49°44'46/.776 E00°21'21/.365	295 90	120.45 4.925 252.35 40.80	189° 18 3600 36 009°	I
64	Flers N48°44'57/.952 W00°35'44/.737	661 202	121.15 5.275 253.05 41.45	063° 05 3800 23 243°	—
33	Goulet N48°44'58/.979 W00°06'41/.688	617 188	119.50 4.450 251.40 39.85	036° 21 3700 35 216°	—
47	Guyancourt N48°45'31/.523 E02°04'47/.794	525 160	120.25 4.825 252.15 40.60	051° 04 2900 22 231° 082° 07 2400 25 262° 142°·13 2600 31·322°	—
36	Hauterive N48°29'59/.995 E00°12'00/.004	476 145	119.65 4.525 251.55 40.00	151° 15 3700 32 331°	—
25	Lantheuil B-9 N49°16'17/.286 W00°32'18/.304	175 53	119.05 4.225 250.95 39.40	070° 06 3800 24 250°	—
17	Le Molay A-9 N49°15'41/.691 W00°52'54/.900	105 32	118.60 4.000 250.50 38.95	051° 04 4400 22 231°	—
8	Lessay A-20 N49°12'05/.096 W01°30'07/.133	66 20	121.75 5.650 253.80 42.20	073°·06 4800 24·253° 134° 12 5800 30 314°	X
2	Lignerolles A-12 N49°10'30/.513 W00°47'21/.361	405 123	119.30 4.350 251.20 39.65	120° 11 4800 29 300°	—
18	Longues-sur-Mer B-11 N49°20'34/.573 W00°42'21/.357	225 69	118.65 4.025 250.55 39.00	130° 12 4300 30 310°	—
48	Lonrai N48°28'03/.060 E00°02'14/.242	515 157	120.30 4.850 252.20 40.65	069° 06 4700 24 249°	—
4	Maupertus A-15 N49°38'59/.987 W01°28'01/.017	441 134	120.40 4.900 252.30 40.75	111° 10 4800 28 291°	—
6	Meautis A-17 N49°16'59/.990 W01°18'00/.014	83 25	121.45 5.425 253.35 41.75	090° 08 4400 26 270°	—
77	Merville Calonne N50°37'13/.233 E02°39'12/.205	131 40	121.65 5.600 253.70 42.10	042° 03 4900 21 222° 082°·XX 4900 XX·262° 145° 14 5100 32 325°	X
57	Orly N48°44'06/.108 E02°23'30/.508	272 83	120.75 5.075 252.65 41.10	022° 01 3600 19 202° 076°·07 3600 25·256°	—
16	Picauville A-8 N49°23'46/.782 W01°24'40/.669	73 22	118.55 3.975 250.45 38.90	120° 11 4400 29 300°	—
56	Poix N49°49'07/.130 E01°58'38/.636	547 167	120.70 5.050 252.60 41.05	047°·04 5100 22·227° 098° 09 5100 27 278°	X
60	Ronai N48°49'24/.403 W00°09'40/.673	860 262	120.95 5.175 252.85 41.25	083° 07 4100 25 263° 134°·12 4500 30·314°	X
61	Rouen-Boos N49°23'13/.232 E01°10'44/.737	493 150	121.00 5.200 252.90 41.30	047° 04 3500 22 227°	—
23	Rucqueville B-7 N49°15'05/.085 W00°34'49/.819	193 59	118.95 4.175 250.85 39.30	100° 09 4700 27 280°	—

IMPROPERLY NAMED RUNWAYS ARE IN STRIKETHROUGH

Adjust the above magnetic headings when flying in the following years (expect 1-2 degrees of error):
 1935-1941 +1° 1951-1959 -1° 1960-1971 -2° 1972-1979 -3° 1980-1985 -4° 1986-1995 -5°
 1996-2001 -6° 2002-2009 -7° 2010-2016 -8° 2017-2020 -9° 2021-2026 -10°

AD Normandy 2.0, Part 4

Average magvar: -9° (1944) / +1° (2023)
 The magnetic headings below are valid from 1942 to 1950

DimOn

ID	France	ELEV. FEET METERS	VHF HF UHF FM	MAG HDG / 3500 ft (1000m) OR LESS DOT - PRIMARY / LENGTH, feet / GRASS RWY	
1	Saint Pierre du Mont A-1 N49°23'25/.430 W00°57'25/.425	103 31	118.75 4.075 250.65 39.10	102° 09 4900 27 282°	—
70	Saint-Andre-de-I Eure N48°53'28/.475 E01°16'05/.099	473 144	121.50 5.450 253.40 41.80	058° 05 5000 23 238° 136°·13 5000 31·316°	—
63	Saint-Aubin N49°53'06/.100 E01°04'/49.825	312 95	121.10 5.250 253.00 41.40	DAMAGED, LANDABLE 133° 12 3500 31 313°	—
76	Saint-Omer Wizernes N50°43'43/.729 E02°13'55/.932	213 65	121.60 5.575 253.65 42.05	039°·03 1700 21 219° 099°·XX 2000 XX·279°	—
21	Sainte-Croix-sur-Mer B-3 N49°19'13/.216 W00°31'02/.035	160 49	118.85 4.125 250.75 39.20	100° 09 4500 27 280°	—
9	Sainte-Laurent-sur-Mer A-21 N49°21'52/.867 W00°52'24/.409	62 19	121.80 5.675 253.85 42.25	117° 11 4800 29 297°	—
24	Sommervieu B-8 N49°18'00/.013 W00°40'15/.257	187 57	119.00 4.200 250.90 39.35	096° 09 4500 27 276°	—
55	Triqueville N49°20'10/.172 E00°27'29/.496	404 123	120.65 5.025 252.55 41.00	168° 15 3800 34 348°	—
42	Villacoublay N48°46'02/.040 E02°12'18/.300	558 170	120.00 4.700 251.90 40.35	131° 12 3900 30 311°	—
38	Vrigny N48°40'20/.336 W00°00'07/.129	581 180	119.75 4.575 251.65 40.10	145° 14 3800 32 325°	—

IMPROPERLY NAMED RUNWAYS ARE IN STRIKETHROUGH

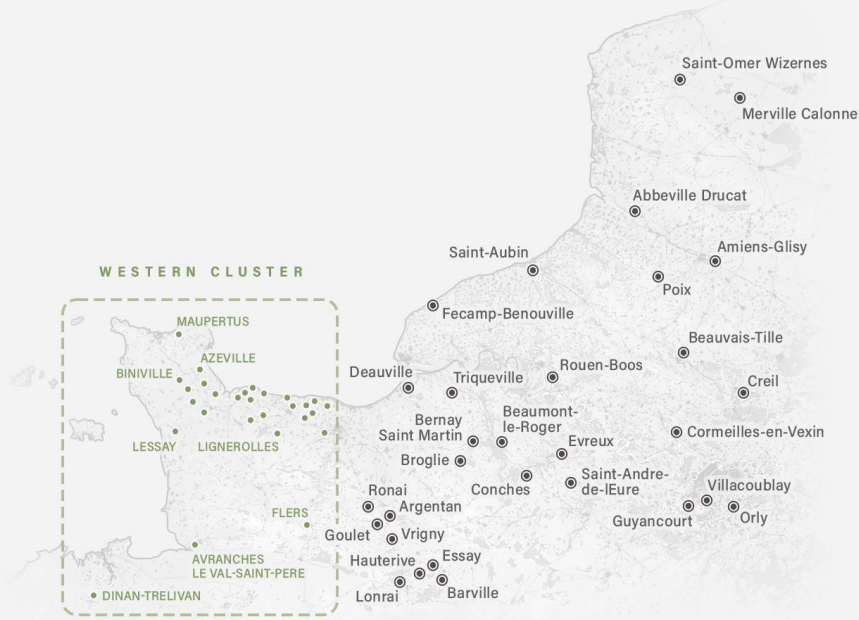

Adjust the above magnetic headings when flying in the following years (expect 1-2 degrees of error):
 1935-1941 +1° 1951-1959 -1° 1960-1971 -2° 1972-1979 -3° 1980-1985 -4° 1986-1995 -5°
 1996-2001 -6° 2002-2009 -7° 2010-2016 -8° 2017-2020 -9° 2021-2026 -10°

AIRPORT DATA NORMANDY 1944

By Minsky

<https://www.digitalcombatsimulator.com/en/files/3312200/>

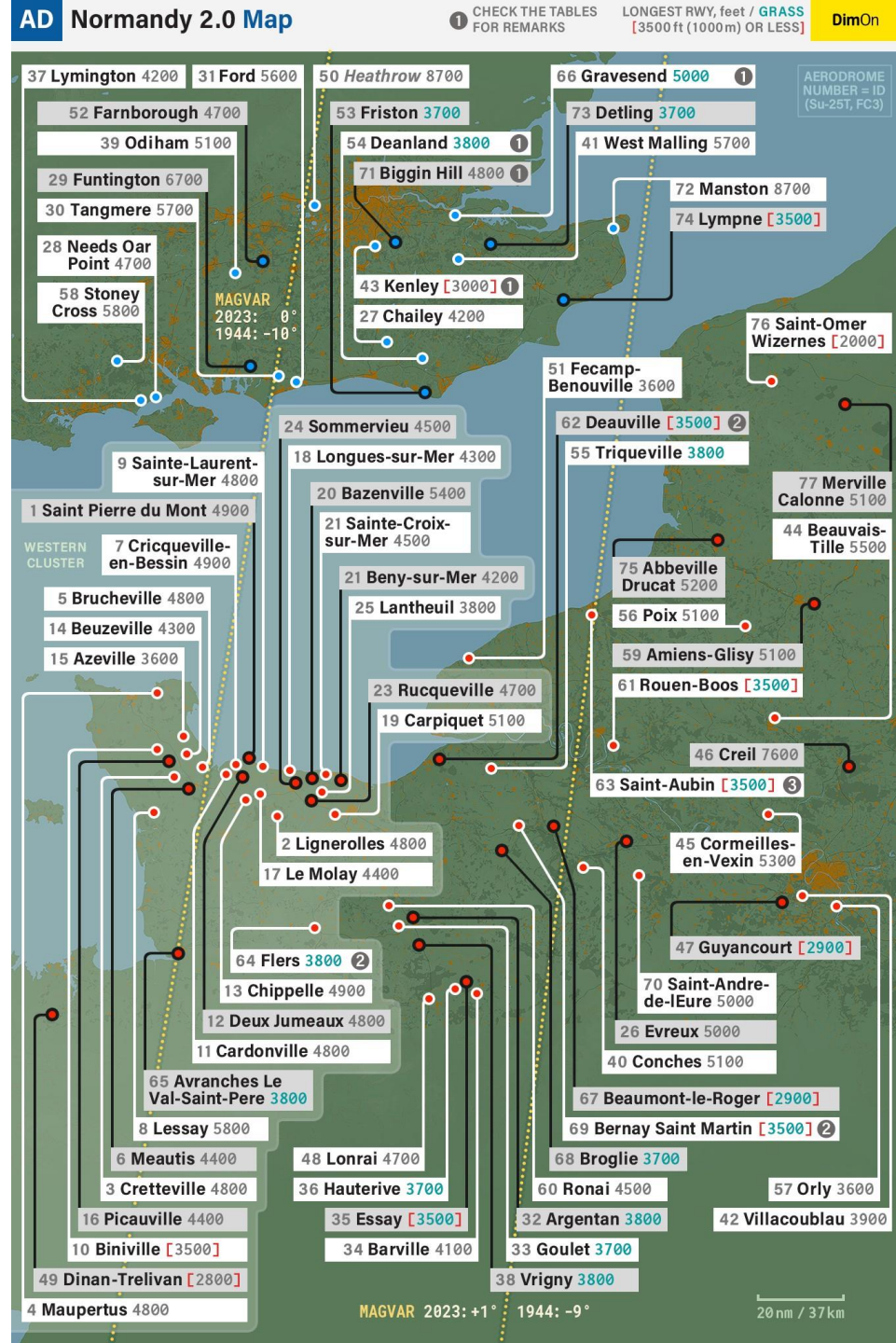

AIRPORT DATA ENGLISH CHANNEL 1944

By Minsky
<https://www.digitalcombatsimulator.com/en/files/3312200/>

AD The Channel

The magnetic headings below are valid from 1938 to 1950

ID	UK England	DEG° MIN' SEC' / DCML METERS	ELEV. FEET METERS	VHF HF UHF FM	MAG HDG / 3500 ft (1000m) OR LESS DOT - PRIMARY / LENGTH, feet / GRASS RWY
1	Biggin Hill N51°19'36' .602 E00°01'51' .866	553 169	118.20 3.850 250.20 38.60	040° 04 4700 22 220° 059° 05 2300 23 239° 119° 12 2500 30 299°	
8	Detling N51°18'18' .302 E00°35'59' .991	623 190	118.60 4.050 250.60 39.00	058° 05 3700 23 238°	
9	Eastchurch N51°23'24' .408 E00°50'48' .814	40 13	118.05 3.775 250.05 38.45	034° 02 3100 20 214° 109° 10 3500 28 289°	
6	Hawkinge N51°06'42' .714 E01°09'36' .615	525 160	118.50 4.000 250.50 38.90	011° 01 2500 19 191° 050° 05 3100 23 230°	
11	Headcorn N51°10'57' .956 E00°41'22' .369	115 35	118.15 3.825 250.15 38.55	024° 02 3800 20 204° 104° 10 4100 29 284°	
10	High Halden N51°07'17' .298 E00°41'37' .624	105 32	118.10 3.800 250.10 38.50	042° 04 4300 22 222° 113° 11 3900 29 293°	
7	Lympne N51°04'50' .839 E01°01'01' .022	351 107	118.55 4.025 250.55 38.95	031° 02 2600 20 211° 145° 13 3200 31 325° 169° 16 3500 34 349°	
5	Manston N51°20'31' .518 E01°20'46' .768	161 50	118.45 3.975 250.45 38.85	067° 04 4800 22 247° 113° 10 9000 28 293°	
France					
1	Abbeville Drucat N50°08'36' .607 E01°49'55' .916	184 56	118.25 3.875 250.25 38.65	034° 02 5100 20 214° 100° 09 5100 27 280° 142° 13 5100 31 322°	
4	Dunkirk Mardyck N51°01'46' .777 E02°15'08' .147	16 5	118.40 3.950 250.40 38.80	091° 08 2000 26 271°	
2	Merville Calonne N50°37'10' .170 E02°38'17' .287	52 16	118.30 3.900 250.30 38.70	048° 04 5100 22 228° 088° 08 5100 26 268° 149° 14 5000 32 329°	
3	Saint Omer Longuenesse N50°43'43' .721 E02°13'54' .915	220 67	118.35 3.925 250.35 38.75	040° 03 1600 21 220° 097° 08 2000 26 277°	

IMPROPERLY NAMED RUNWAYS ARE IN STRIKETHROUGH



Adjust the above magnetic headings when flying in the following years (expect about 1 degree of error):
 1951-1954 -1° 1955-1961 -2° 1962-1967 -3° 1968-1972 -4° 1973-1979 -5° 1980-1987 -6°
 1988-1995 -7° 1996-2001 -8° 2002-2009 -9° 2010-2015 -10° 2016-2021 -11° 2022-2026 -12°

AD The Channel Map

RUNWAY LENGTH, feet / GRASS [3500 ft (1000m) OR LESS] DimOn

The magnetic headings below are valid from 1938 to 1950

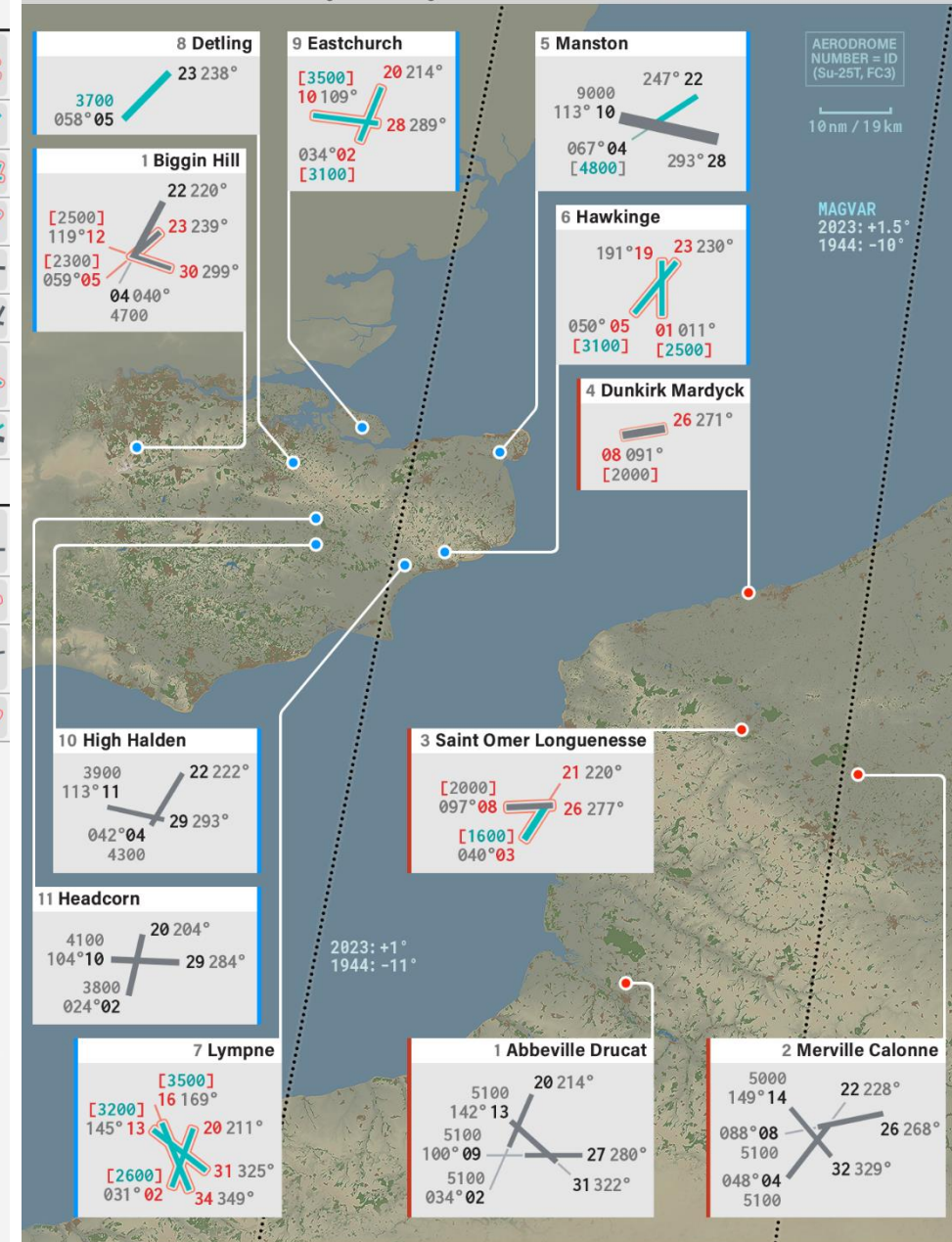

Adjust the above magnetic headings when flying in the following years (expect about 1 degree of error):
 1951-1954 -1° 1955-1961 -2° 1962-1967 -3° 1968-1972 -4° 1973-1979 -5° 1980-1987 -6°
 1988-1995 -7° 1996-2001 -8° 2002-2009 -9° 2010-2015 -10° 2016-2021 -11° 2022-2026 -12°

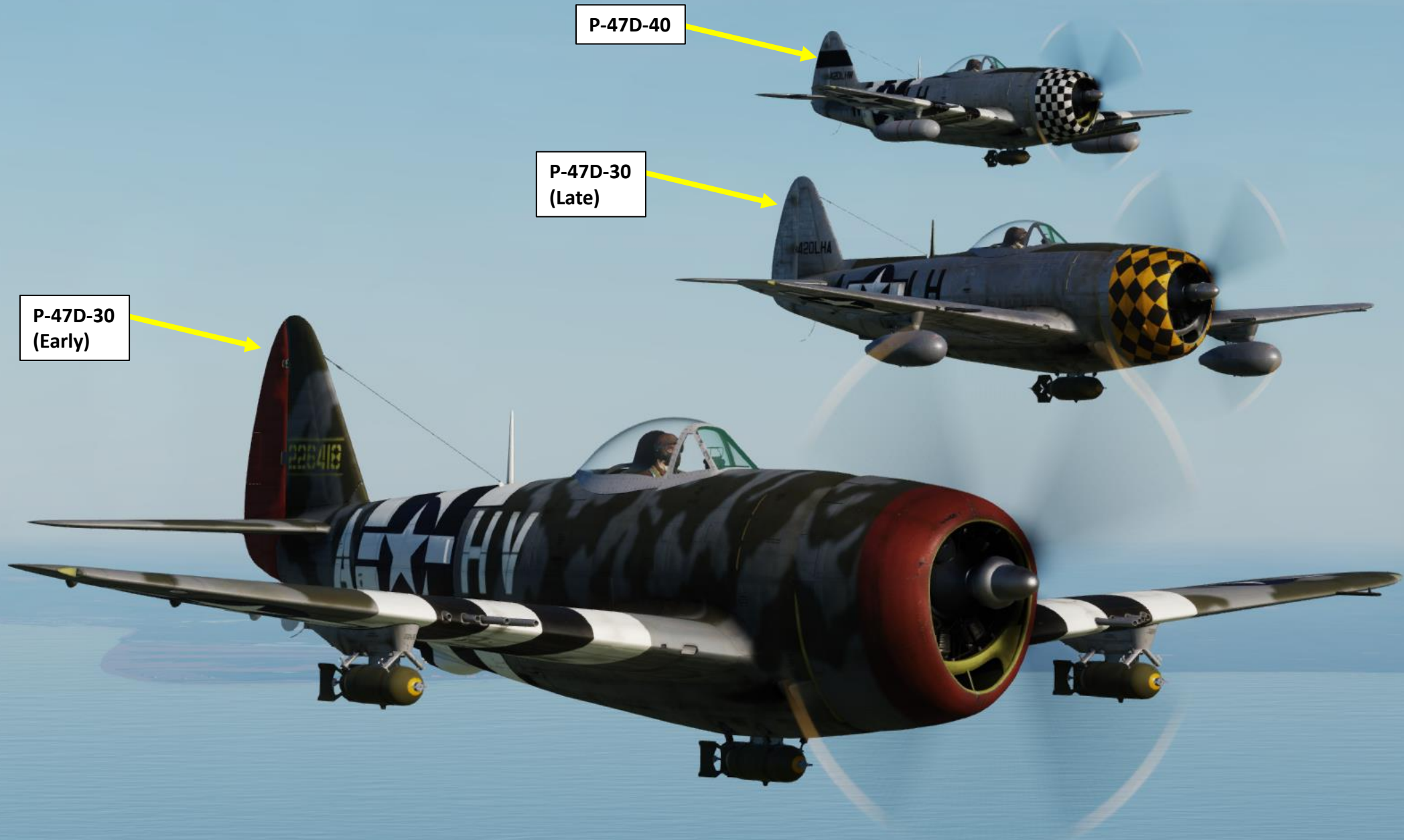

P-47D-40

P-47D-30
(Late)

P-47D-30
(Early)

P-47D-30 EARLY SERIES

The P-47D-30 Early Series has some specific modifications, such as:

- Square-shaped throttle
- Mark VIII Gunsight
- Old Bomb Releasing mechanism
- No dorsal fin
- No Weapon Release Button on the stick

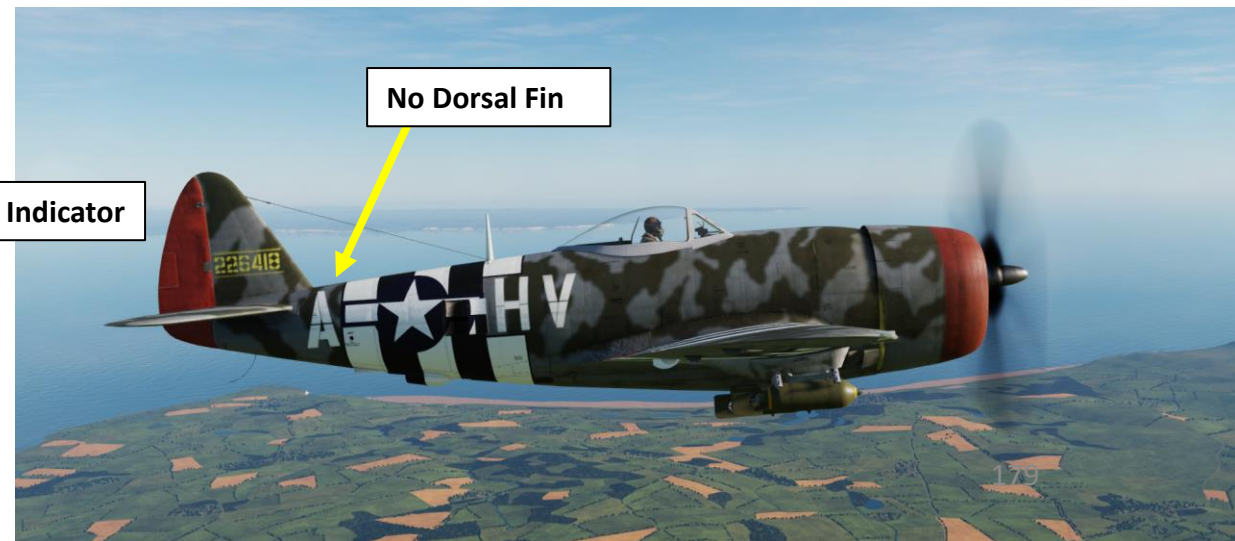
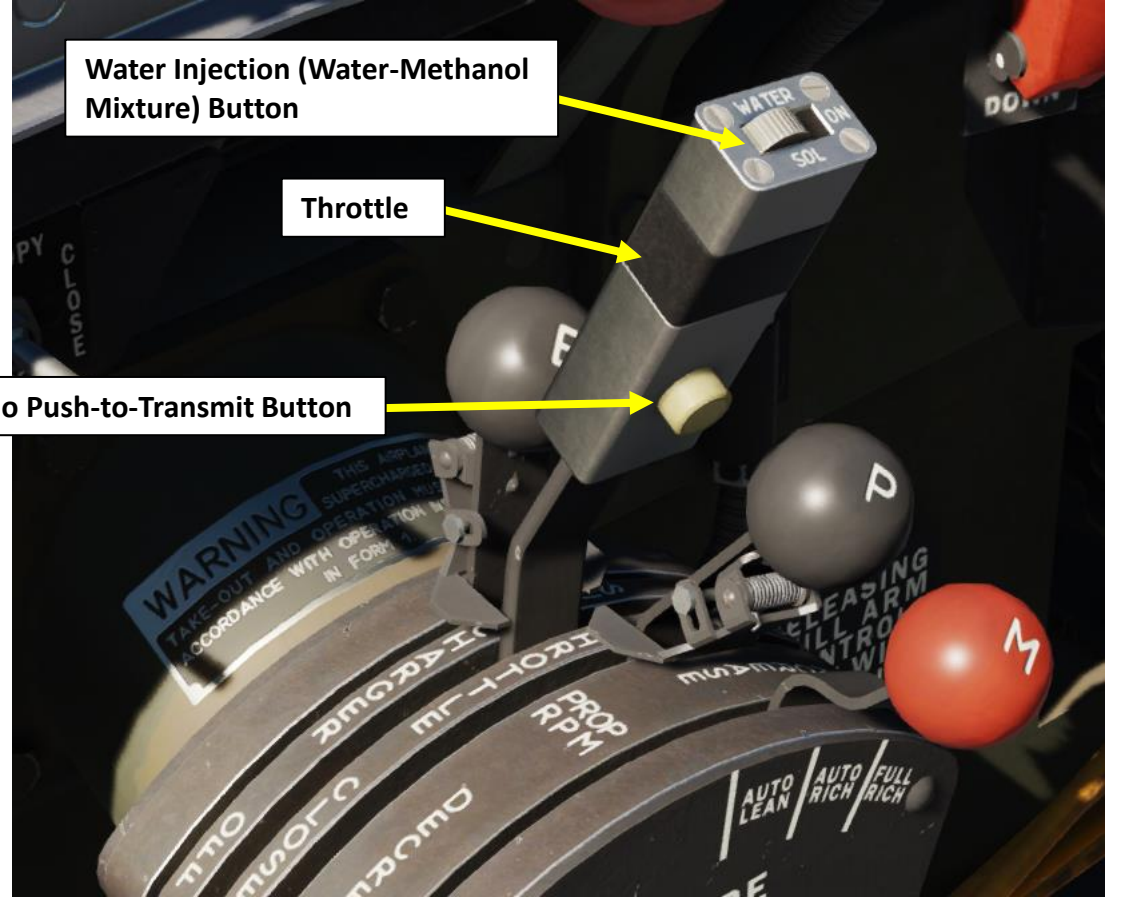

P-47D-30 LATE SERIES

The P-47D-30 Late Series has some specific modifications, such as:

- Modern rounded throttle
- K-14 Gyro Gunsight
- Modern Bomb release panel
- Dorsal Fin: provides an improvement to directional stability since the turbulence behind the bubble canopy caused directional control problems at certain speeds

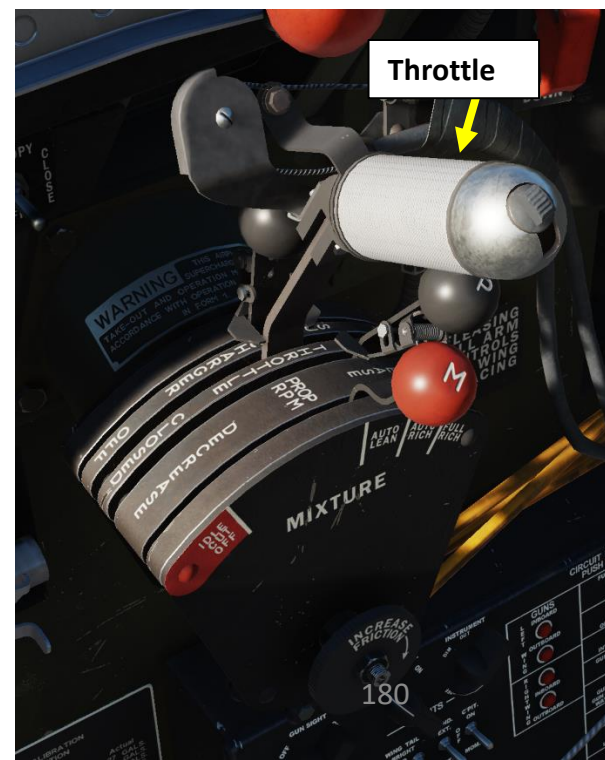
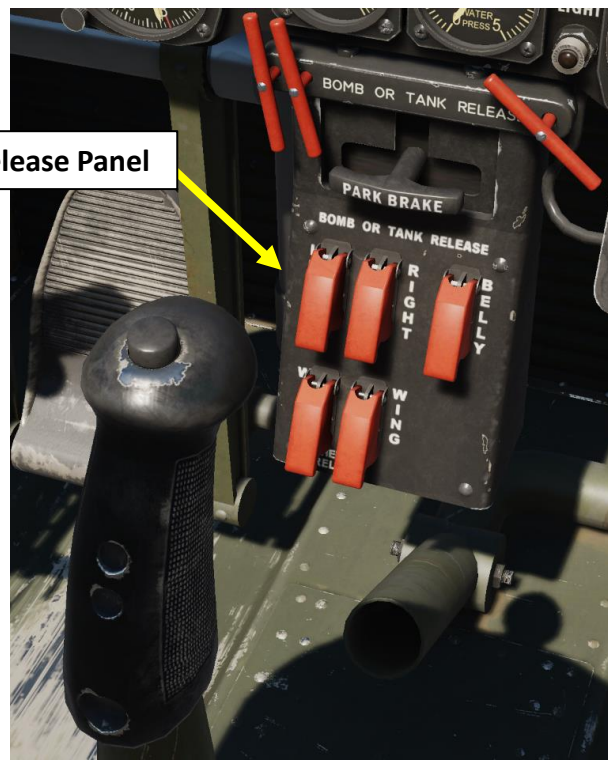
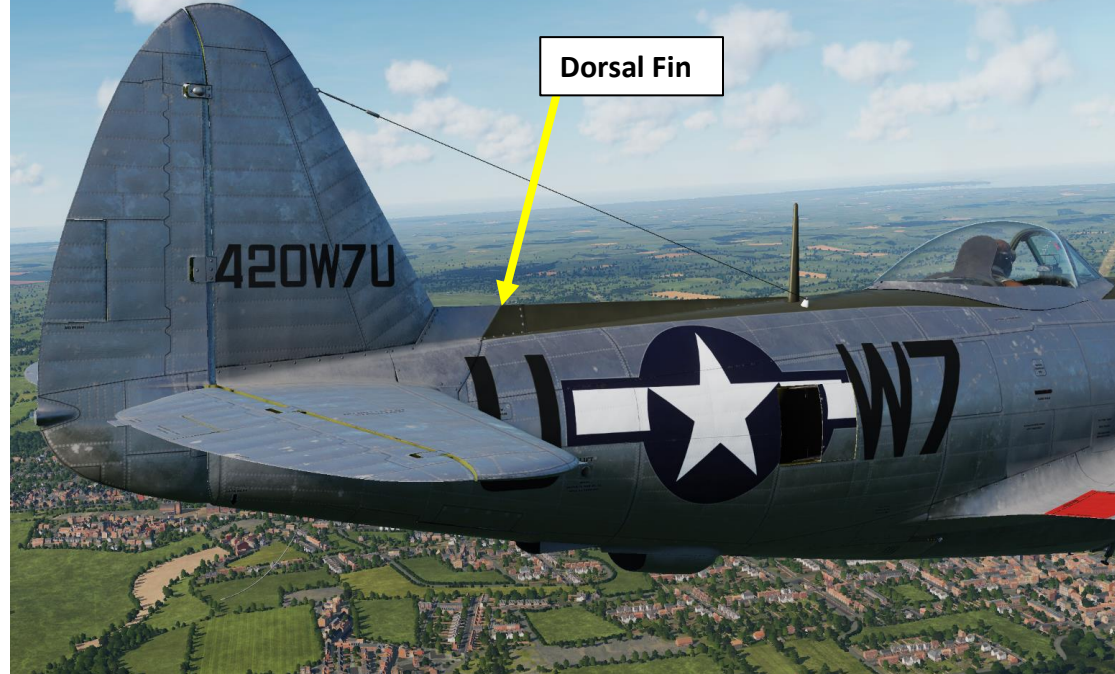

P-47D-40 SERIES

The P-47D-40 Series has some specific modifications, such as:

- Modern rounded throttle
- K-14 Gyro Gunsight
- Rockets (M-8 “Bazooka” and HVAR types)
- Armament Selector panel
- Rocket Selector panel
- Dorsal Fin: provides an improvement to directional stability since the turbulence behind the bubble canopy caused directional control problems at certain speeds

K-14 Gyro Gunsight

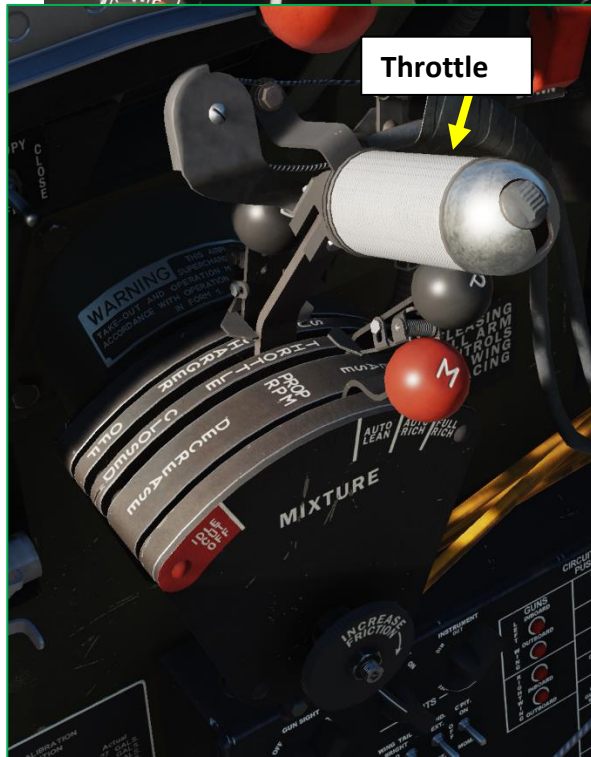
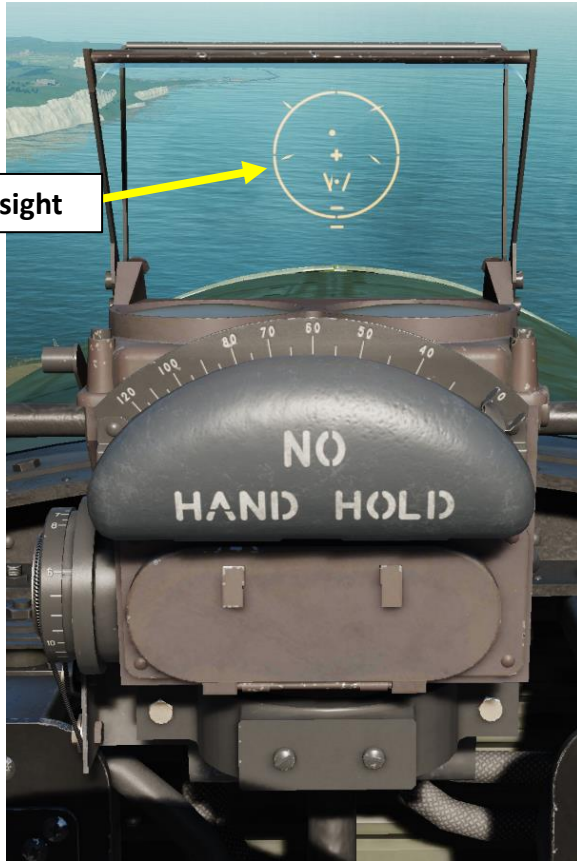

Throttle

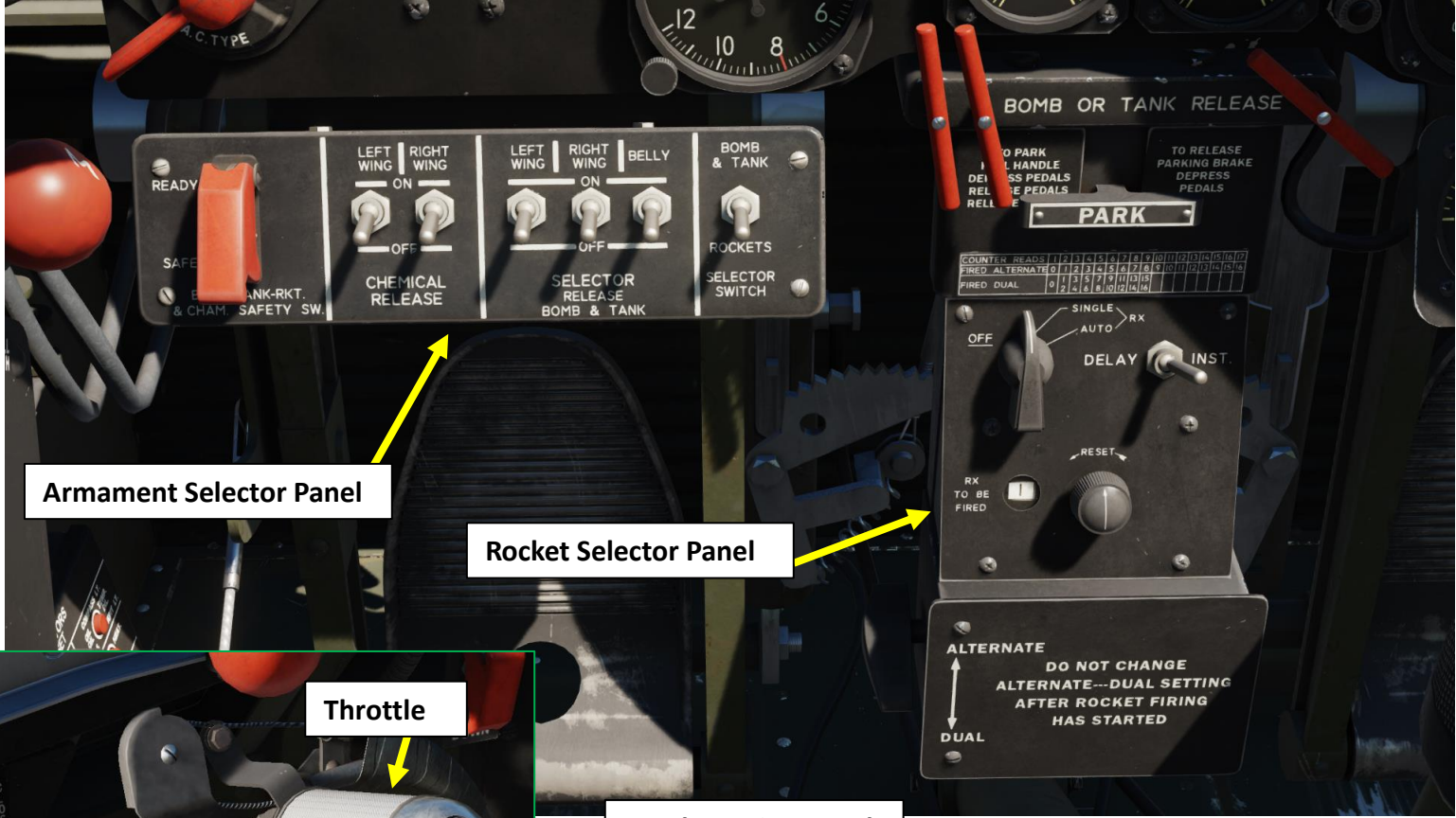

Armament Selector Panel

Rocket Selector Panel

Bomb Arming Panel



As with all warbirds, dogfighting in P-47 Thunderbolt is an art that is easy to learn, but very difficult to master.

The Thunderbolt was built to be a long-range escort fighter, which meant it had to be able to operate at high altitudes. It may sound counter-intuitive when you look at how heavy the plane is, but the turbosupercharger of the Double Wasp made the P-47 very effective above 20,000 ft. The mantra of a good P-47 pilot should be to gain as much altitude as possible as quickly as he can using the “best climb speed” (V_y), which is roughly 160 mph. Every thousand feet you gain is potential energy that you can later convert into speed when diving, which is the way Thunderbolt aces flew the plane.

Therefore, the Thunderbolt is best used at altitudes of 20,000 ft and higher. This is where it will have the greatest performance advantage over the Bf.109 and the FW190. However, most dogfights occurring in multiplayer servers happen at lower altitudes between 5,000 and 15,000 ft, which is where the Messerschmitts and Focke-Wulfs will dominate in terms of climb rate and diving speed. This partially explains why the P-47 can sometimes seem “worse” in most aspects than other fighters at low altitude: it was meant to be a high-altitude fighter. If you happen to be forced to fight on the 109’s terms down low, you are at a serious disadvantage from the very beginning. When you are forced to fight at medium to low altitudes, it is better to stay high and perform controlled dives and avoid getting tangled up in prolonged turning fights. I cannot put enough emphasis on the “fly-with-a-wingman” advice listed below; the best way to operate is like a pack of wolves.

During dogfights, I would advise you to keep your energy state (airspeed and altitude) high at all times. These principles apply to every single aircraft, but particularly to the P-47 since it has such trouble climbing due to its weight. Do keep in mind that the P-47 can turn very well at high speeds. Just make sure you don’t over-G in the process.

The P-47D must be used in the following way if you want to survive against experienced Bf.109 or FW.190 pilots.

- Always fly with a wingman
- Always fly with a high energy state (high airspeed and altitude)
- Do not attempt to outclimb a 109 or 190
- Bring the fight to high altitudes if you can to fly your plane in the combat environment it was designed for
- Master your aircraft: know your engine limits and airspeed limits by heart and practice manoeuvres to avoid stalls and spins.

Here is an insightful P-47 dogfight debrief that expands on do’s and do-not-do’s:

<https://youtu.be/pTv5VsH5TvU>



The P-47 has a number of advantages that make it an aircraft that is very capable. Its bubble canopy provides exceptional visibility and the eight 0.50 cal machineguns offers a superb gunnery platform. The aircraft's sturdy airframe and engine can also take more punishment than other planes like the Mustang or Spitfire. Read up on Robert Johnson's account of the 100+ bullet holes he counted on his P-47 after a sortie... it's a riveting tale.

I also suggest you check out Greg's Airplanes and Automobiles P-47 Thunderbolt Series:

- *Part 1 – Design & Speed*
<https://youtu.be/mzQuq2FHdeE?list=PLD2EcpzcvT-tvemNaIYUfZfV3s8K8Gbgh>
- *Part 1A – Throttle & Boost Lever Use*
<https://youtu.be/HHtypRJUNKY?list=PLD2EcpzcvT-tvemNaIYUfZfV3s8K8Gbgh>
- *Part 2 – Dive Speeds & Mach Number*
<https://youtu.be/wwP6qv8jOhI?list=PLD2EcpzcvT-tvemNaIYUfZfV3s8K8Gbgh>
- *Part 3 – Armor & Protection*
<https://youtu.be/aCnt3J65UqE?list=PLD2EcpzcvT-tvemNaIYUfZfV3s8K8Gbgh>
- *Part 4 – Climb Rate*
<https://youtu.be/UHUmWTnBuhU?list=PLD2EcpzcvT-tvemNaIYUfZfV3s8K8Gbgh>
- *Part 5 – Maneuverability*
<https://youtu.be/KahHLtYlveQ?list=PLD2EcpzcvT-tvemNaIYUfZfV3s8K8Gbgh>
- *Part 6 – Range, Deceit & Treachery*
<https://youtu.be/aCLa078v69k?list=PLD2EcpzcvT-tvemNaIYUfZfV3s8K8Gbgh>





Following the end of the Battle of Britain, RAF Fighter Command moved from defensive to offensive operations where they would engage German fighters on the other side of the Channel; the operational instructions were ready by December 1940.

There would be two types of offensive operation:

- "Rhubarb" (initially called Mosquito) in which small patrols would cross under cover of cloudy conditions and engage any aircraft they found and on clear weather days
- "Circus" which would send several squadrons - possibly with a few bombers - in sweeps of northern France. Circus came to mean an operation with bombers.

Rhubarb patrols began in December 1940; while the pilots were allowed to attack ground targets if any presented itself their primary objective was to bring down German aircraft. By mid-June 1941, Fighter Command had flown 149 Rhubarb patrols (336 sorties) claiming seven enemy aircraft brought down for loss of eight pilots on the British side. Circus operations with bombers began in January and eleven had been carried out by June, the targets including docks on the French coast and airfields. More than forty sweeps without bombers had been made in the same period.

While Fighter Command's priority was the German fighters, Bomber Command concentrated on destroying the ground targets. At higher level in the RAF it was felt that the effects on the war by damage that could be inflicted by the bombers would be minimal; the commanders of Bomber and Fighter Commands held a conference that agreed that the **purpose of a Circus was to force German fighters into combat in circumstances that favoured the British and to that end the bombers had to do enough damage that the Luftwaffe could not ignore the attacks.**

The P-47 participated in a significant number of "Ramrod" operations, which were similar to Circus but with destroying a target being the principal aim. I suggest you try out some escort missions if you want to experience a very different way to fly in the P-47.

Here is an interesting clip of a Ramrod operation to Emden in 1943:

<https://youtu.be/WiU8EbpYd2o>



SQUADRON ESCORT OF A BOMBER FORMATION

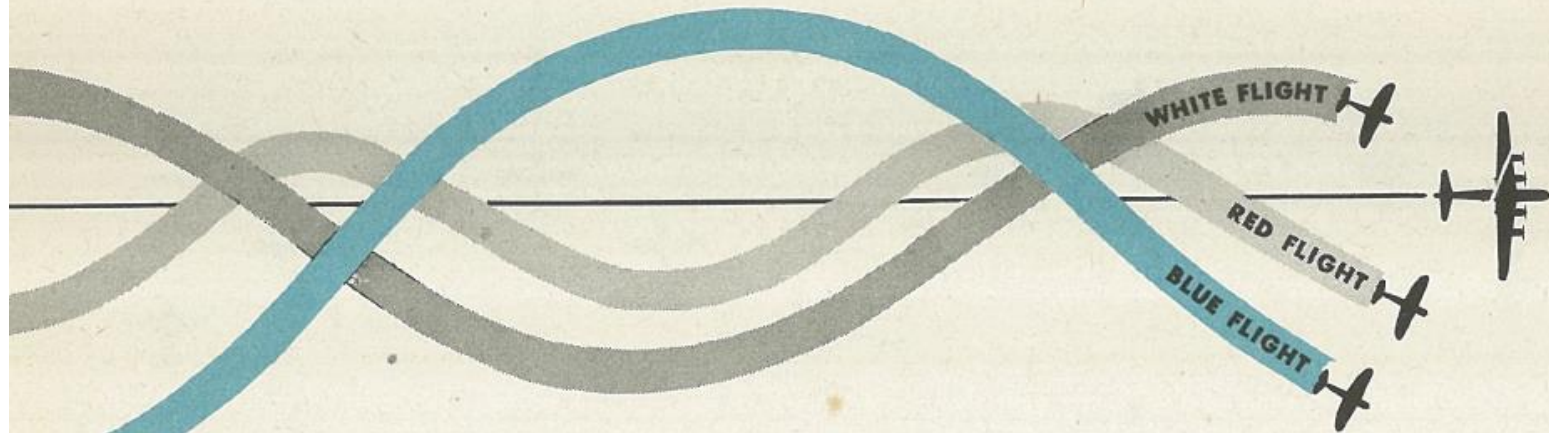

TOP COVER 33,000 FEET

BLUE FLIGHT

ESCORT COVER 28,000 FEET

WHITE FLIGHT

CLOSE ESCORT 25,000 FEET

RED FLIGHT

BOMBER FORMATION 23,000 FEET



Taming taildraggers is much more difficult than meets the eye, especially during the takeoff and landing phase. Here is a useful and insightful essay on the art of flying taildraggers wonderfully written by *Chief Instructor*. I highly recommend you give it a read.

Link: <https://drive.google.com/open?id=0B-uSpZROuEd3V3Jkd2pfa0xRRW8>

TAMING TAILDRAGGERS

Essay by Chief Instructor (CFI)

PART 1

Why taildraggers are tricky and how to overcome it

What do I know about it? Well, I have spent a significant proportion of my professional flying career teaching both experienced and novice pilots how to fly and handle tail-dragging aircraft. This amounts to several thousand hours of tailwheel training alone, though who's counting! These aircraft include among them modern high performance aerobatic aircraft and a variety of more vintage types from DH Tiger Moths, to Harvards. I can't recall off the top of my head exactly how many students I've worked with over the years, but it's well over 200! Best of all, they have all gone on to fly extensive tailwheel ops in a variety of types and to the best of my knowledge, only 2 of them have crashed anything since!

As a significant number of pilots here are expressing difficulties with tailwheel handling,

THANK YOU TO ALL MY PATRONS

Creating these guides is no easy task, and I would like to take the time to properly thank every single one of my [Patreon](#) supporters. The following people have donated a very generous amount to help me keep supporting existing guides and work on new projects as well:

- [ChazFlyz](#)

P-47D

THUNDERBOLT



INSTANT ACTION
 CREATE FAST MISSION
 MISSION
 CAMPAIGN
 MULTIPLAYER

LOGBOOK
 ENCYCLOPEDIA
 TRAINING
 REPLAY

MISSION EDITOR
 CAMPAIGN BUILDER

EXIT



F-86F



F/A-18C
EA



FC3



Fw 190 A-8
EA



Fw 190 D-9



I-16
beta



JF-17
EA



Ka-50



L-39



M-2000C



Mi-8MTV2



MIG-15bis



MIG-19P



MIG-21bis



Normandy



P-47D-30



P-51D