

DCS GUIDE C-101CC AVIOJET

BY CHUCK

LAST UPDATED: 22/04/2020



TABLE OF CONTENTS

- PART 1 – INTRODUCTION
- PART 2 – CONTROLS SETUP
- PART 3 – COCKPIT & AIRCRAFT DESCRIPTION
- PART 4 – START-UP PROCEDURE
- PART 5 – TAXI & TAKEOFF
- PART 6 – LANDING
- PART 7 – ENGINE MANAGEMENT
- PART 8 – AERODYNAMICS
- PART 9 – WEAPONS & ARMAMENT
- PART 10 – RADIO TUTORIAL
- PART 11 – FLIGHT DIRECTOR
- PART 12 – NAVIGATION
- PART 13 – PRECISION APPROACHES
- PART 14 – C-101EB SMOKE EQUIPMENT
- PART 15 – EMERGENCY PROCEDURES
- PART 16 – MULTICREW



The **CASA C-101 Aviojet** is a two seat jet-powered low-wing single engine advanced trainer and light attack aircraft manufactured by the Spanish company Construcciones Aeronáuticas S.A. (CASA). It is used by the Spanish Air Force (Ejército del Aire), where it is nicknamed Mirlo (Blackbird), the Chilean Air Force, the Honduran Air Force (both call it Halcón, Falcon) and the Royal Jordanian Air Force. Spanish pilots informally refer to the Aviojet as the "Culopollo", which literally means "chicken butt".

It is the airplane used by the Patrulla Águila in its aerobatic displays. Its designation as C-101 follows the designation system used for aircraft designed by CASA, with the initial of the manufacturer "C" followed by a three-digit number. The first digit means the number of motors, one in this case, and the two following mean the first single-engine designed by the company.

The C-101 "Aviojet" responds to the request of the Spanish Air Force for a training and light attack aircraft to replace the Hispano Aviación HA-200 Saeta, the HA-220 Súper Saeta and the Lockheed T-33. On the 16th of September of 1975, the Spanish Air Force signed a contract with CASA for the design, construction and development of the new jet trainer.

The plane was defined as a subsonic flight basic and advanced trainer, but should be equipped with the most modern equipment on board to facilitate the transition to fighter jets, it should possess good acceleration to get future military pilots accustomed to the performances of more advanced aircraft, it should also be very maneuverable at high and low level, and finally it should withstand load factors between +7.5 and -3.75 G. As if all that were not enough, the Aviojet should be able to land at 100 knots and be able to remain in inverted flight for 20 seconds.



C-101CC - Chile



C-101CC - Honduras

The C-101EB is the version ordered by the Spanish Air Force, where it receives the designation E.25. It is the version that has been manufactured in larger numbers, 88 airplanes built. The Aviojet (officially nicknamed "Mirlo" and unofficially "Culopollo" in Spain) has several roles within the Spanish Air Force, the most famous being flight training in the Basic Flight School. The C-101EB is the release version of the aircraft and therefore the less sophisticated.

The C-101CC first flew on the 16th of November of 1983 and is a light attack optimized version, built under request from the Chilean Air Force. It has the same ability to carry weapons as the C-101BB (export version of the C-101EB), but with an increased autonomy, which in this model comfortably exceeds seven hours. In addition, the turbofan Garrett reaches 4700 pounds of thrust. It is known as A-36 Falcon in Chile, where 23 units (one made in Spain, the rest mounted at ENAER in Chile under license) were delivered.

The Chilean Air Force studied the possibility of using it as a launching platform for the Sea-Eagle anti-ship missile, for which purpose the C-101 would be fitted with a Ferranti HUD and an inertial guidance system FIN 2000. However, this possibility was canceled when the Chilean Navy bought 8 Eurocopter Cougar helicopters, equipped with AM.39 Exocet anti-ship missiles. Yet the Chilean C-101s have received various modifications of equipment including fire control system and navigation, HUD and possibility of using the Rafael Shafrir 2 air-to-air missile. The C-101CC was also acquired by Jordan, used as trainer and light attack airplane. 16 C-101 serve in the Air College King Hussein at Al-Mafraq Air Base.



C-101CC - Jordan



C-101CC - Spain

In the end, flying the C-101 in DCS brings something very interesting to the table: a trainer that actually teaches you how to fly. The training missions in the C-101 are quite extensive and do not simply tell you “perform X to achieve Y”, but they also explain the reason why certain checks are performed. The C-101 has most of the tools to teach you how to fly in both VFR (Visual Flight Rules) and IFR (Instruments Flight Rules) conditions.

Many different types of faults and malfunctions are modelled in the simulation, which makes Aviodev’s (brilliant) implementation the circuit breakers logic all the more relevant. This makes the C-101 the perfect aircraft to practice emergency procedures. I strongly encourage you to dig through Aviodev’s flight manual. There are plenty of small quirks and details that give the Aviojet personality. Forget about fancy CCIP or CCRP lines: the weapons available for the C-101CC will teach you how to bomb targets using depression tables and proper attack profiles.



CASA C.101CC / A-36 HALCÓN

C.101CC

- Diagrama**
- 1 Cono de proa de fibra de vidrio
 - 2 Antena de grado de plano ILS
 - 3 Puertas de la rueda delantera
 - 4 Bahía de la rueda del tren de aterrizaje delantero
 - 5 Botellas de oxígeno
 - 6 Válvula del extremo exterior del indicador de velocidad
 - 7 Antena TACAN
 - 8 Sonda de temperatura
 - 9 Toma de aire fresco de la cabina
 - 10 Bahía del equipamiento de aeroelectrónica
 - 11 Montaje del pivote de la horquilla de la rueda delantera
 - 12 Gato hidráulico de retracción
 - 13 Puertas de acceso a la bahía de aeroelectrónica, babor y estribor
 - 14 Puntal de la horquilla de la rueda delantera
 - 15 Rueda delantera de retracción hacia delante
 - 16 Tira de luz de formación electroluminiscente
 - 17 Mamparo de presión delantero de la cabina
 - 18 Estaciones estáticas
 - 19 Pedales del timón
 - 20 Columna de control
 - 21 Consola de instrumentos delantera
 - 22 Mira Avimo
 - 23 Panel del parabrisas, sin marco
 - 24 Posición abierta de la bóveda, bóveda individuales
 - 25 Retrovisores del piloto
 - 26 Bóveda de la cabina del piloto estudiante

- 31 Mamparo inclinado de montaje del asiento delantero
- 32 Cableado de control bajo el suelo
- 33 Suelo de presión de la cabina
- 34 Paquete del cañón ventral DEFA de 30 mm
- 35 Paquete de ametralladora Twin Browning de 12,7 mm (encaje alternativo)
- 36 Cámara de munición de la ametralladora, 220 cartuchos por cañón
- 37 Tobogán eyector de cartuchos
- 38 Batería
- 39 Cámara de munición del cañón, 130 cartuchos
- 40 Botella de nitrógeno, bajada de emergencia del tren de aterrizaje
- 41 Suelo de presión de la cabina posterior
- 42 Cerrojo externo de la bóveda posterior
- 43 Consola de instrumentos posterior
- 44 Parabrisas interno entre cabinas
- 45 Asiento eyectable del instructor Martin-Baker Mk 10

- 46 Bóveda de la cabina del instructor
- 47 Depósito de combustible integral exterior de estribor, capacidad interna total de 2.414 litros; 1.730 litros sin depósitos exteriores
- 48 Torres de perrechos de estribor (3)

- 53 Descargadores estáticos
- 54 Alerón de estribor
- 55 Impulsor hidráulico del alerón
- 56 Eje de torsión y conexión operante del alerazo
- 57 Alerazo de ranurado único de estribor
- 58 Antena UHF

- 59 Conexiones de vara de control
- 60 Mamparo de presión trasero inclinado de la cabina
- 61 Toma de aire de babor

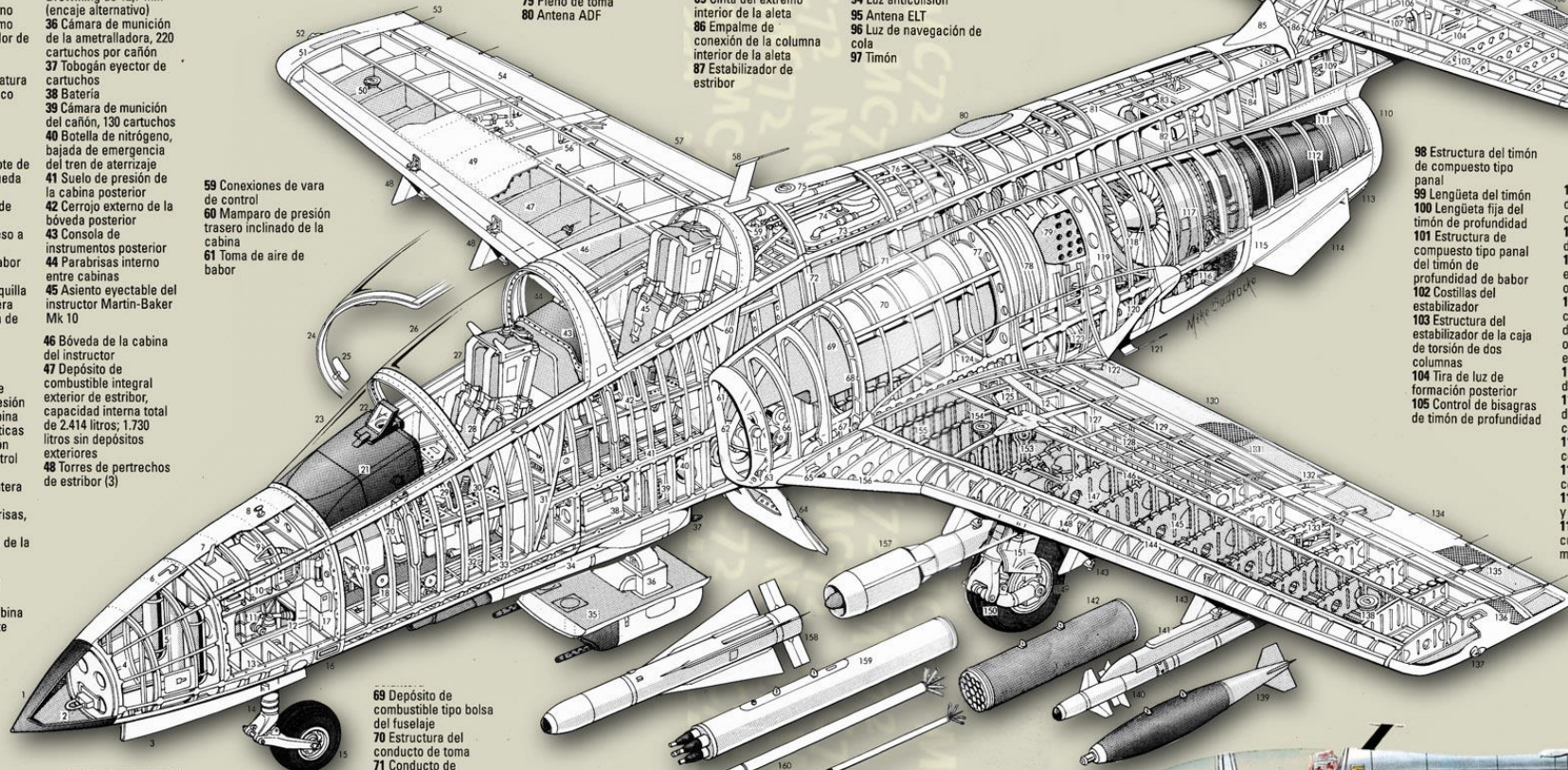
- 66 Paquete de aire acondicionado
- 67 Empalme de conexión atornillado del fuselaje/columna interior del ala
- 68 Marco principal del fuselaje de conexión de la columna interior delantera

- 75 Relleno por gravedad del depósito del fuselaje
- 76 Suministro de aire a la planta de acondicionamiento
- 77 Marco principal del fuselaje de conexión de la columna interior trasera
- 78 Estructura de marco del fuselaje central
- 79 Pleno de toma
- 80 Antena ADF

- 81 Varas de control del estabilizador
- 82 Toma de aire martillo
- 83 Intercambiador de calor primario de expulsión de aire del motor
- 84 Estructura de la espina del fuselaje posterior de sección de la caja
- 85 Cinta del extremo interior de la aleta
- 86 Empalme de conexión de la columna interior de la aleta
- 87 Estabilizador de estribor

- 88 Timón de profundidad de estribor
- 89 Antena HF del eje frontal
- 90 Estructura de la caja de torsión de dos columnas de la aleta
- 91 Costillas de la aleta
- 92 Antena VOR
- 93 Antena VHF del extremo de la aleta
- 94 Luz anticolisión
- 95 Antena ELT
- 96 Luz de navegación de cola
- 97 Timón

- 69 Depósito de combustible tipo bolsa del fuselaje
- 70 Estructura del conducto de toma
- 71 Conducto de expulsión de estratos frontera
- 72 Marco de conexión del fuselaje delantero/central
- 73 Panel de acceso a la bahía del depósito
- 74 Tuberías de ventilación/alimentación de combustible

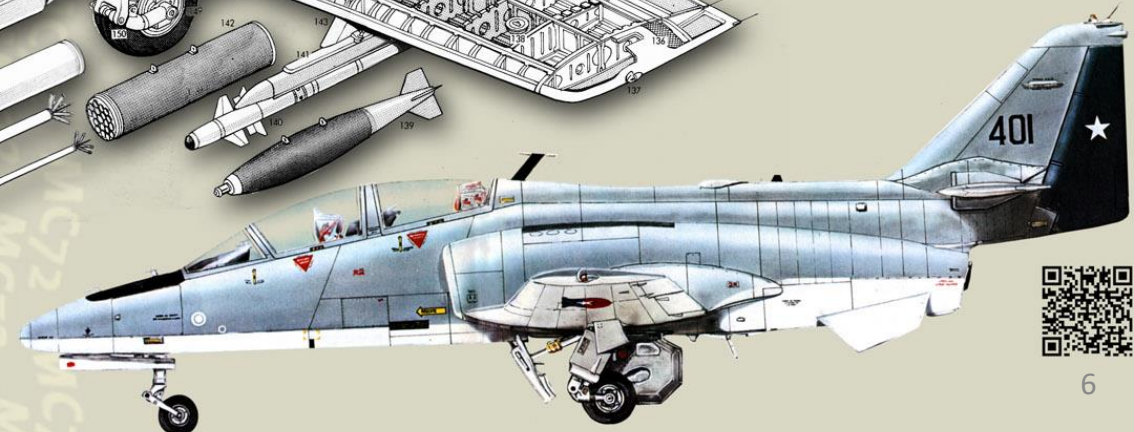


- 98 Estructura del timón de compuesto tipo panel
- 99 Lengüeta del timón
- 100 Lengüeta fija del timón de profundidad
- 101 Estructura de compuesto tipo panel del timón de profundidad de babor
- 102 Costillas del estabilizador
- 103 Estructura del estabilizador de la caja de torsión de dos columnas
- 104 Tira de luz de formación posterior
- 105 Control de bisagras de timón de profundidad

- 106 Montaje de bisagra del estabilizador de orientación
- 107 Control de bisagra del timón
- 108 Placa de sellado del estabilizador de orientación
- 109 Gato tornillo de control de orientación del estabilizador, operado eléctricamente
- 110 Tobera de escape del motor
- 111 Conducto de escape de aire del ventilador, corriente fría
- 112 Escape del motor, corriente caliente
- 113 Parachoques de cola
- 114 Aleta ventral, babor y estribor
- 115 Paneles de la cubierta de la bahía del motor

- 116 Caja de engranajes del equipamiento accesorio
- 117 Motor turboventilador Allied Signal TFE31-5-1J
- 118 Ventilador delantero del motor
- 119 Marco de conexión del fuselaje posterior
- 120 Cinta del eje posterior del extremo interior del ala
- 121 Antena inferior UHF
- 122 Rail guía interior del alerazo
- 123 Reserva hidráulica
- 124 Bahía de la rueda del tren de aterrizaje principal
- 125 Gato hidráulico de retracción
- 126 Columna interior del ala auxiliar de montaje del tren de aterrizaje trasera
- 128 Tirantes del ala
- 129 Costillas de la cubierta del alerazo
- 130 Alerazo de ranurado único de babor
- 131 Estructura de compuesto tipo panel del alerazo
- 132 Rail exterior guía del alerazo
- 133 Impulsor hidráulico del alerón de babor
- 134 Lengüeta fija del alerón
- 135 Estructura tipo panel de compuesto del alerón de babor
- 136 Capotaje del extremo del ala de compuesto
- 137 Luz de navegación de babor
- 138 Relleno por gravedad del depósito exterior del ala de babor

- 139 Bomba HE Mk 82 de 227 kg
- 140 Misil autodefensa aire-aire Matra Magic
- 141 Rail de lanzamiento del misil
- 142 Lanzadora de cohetes LAU-3/A, 19 cohetes FFAR de 70 mm
- 143 Torres de perrechos del ala de babor (3)
- 144 Columna interior delantera
- 145 Depósito exterior integral del ala de babor
- 146 Columna interior principal
- 147 Esqueleto del ala principal
- 148 Costillas del ala frontal
- 149 Rueda principal de babor
- 150 Suspensión del eje posterior
- 151 Puertas de la horquilla de la rueda principal
- 152 Luz de aterrizaje retractable
- 153 Montaje del pivote de la horquilla del tren de aterrizaje principal
- 154 Relleno de gravedad del depósito central del ala
- 155 Depósito de combustible de sección central
- 156 Sección del extremo interior del ala
- 157 Vaina de interferencias Electrónica EL7/555
- 158 Misil aire-tierra ASM-65A Maverick
- 159 Lanzadora cohetes LAU-10, 4 FFAR de 127 mm
- 160 Cohete Zuno de 127 mm



Bind the following axes:

- THRUST – CONTROLS ENGINE RPM
- PITCH, ROLL, RUDDER (DEADZONE AT 0, SATURATION X AT 100, SATURATION Y AT 100, CURVATURE AT 0)
- WHEEL BRAKE LEFT/RIGHT

The screenshot shows the 'CONTROL OPTIONS' window with the 'AXIS TUNE PANEL' open. The 'AXIS TUNE PANEL' is a modal window for configuring joystick axes. It features a central graph with a blue diagonal line and a red square marker at the center. To the right of the graph are four sliders: 'Deadzone' (set to 0), 'Saturation X' (set to 100), 'Saturation Y' (set to 100), and 'Curvature' (set to 0). Below the sliders are three checkboxes: 'Slider' (checked), 'Invert' (unchecked), and 'User Curve' (unchecked). At the bottom of the panel is a dropdown menu labeled 'Axis Tune' with 'JOY_X' selected. The background shows a list of actions on the left and a table of joystick axes on the right.

Axis	Deadzone	Saturation X	Saturation Y	Curvature
JOY_X	0	100	100	0
JOY_Y				
JOY_Z				
JOY_RZ				
JOY_X				
JOY_Y				

OPTIONS

SYSTEM **CONTROLS** GAMEPLAY MISC. AUDIO SPECIAL VR

C-101CC Axis Commands Reset category to default Clear category Save profile as Load profile

Action	Category	Keyboard	Throttle - HOTAS W...	Joystick - HOTAS Wa...	Saitek Pro Flight Co...	TRA
Absolute Camera Horizontal View						
Absolute Camera Vertical View						
Absolute Horizontal Shift Camera View						
Absolute Longitude Shift Camera View						
Absolute Roll Shift Camera View						
Absolute Vertical Shift Camera View						
Camera Horizontal View (mouse)						
Camera Vertical View (mouse)						
Camera Zoom View (mouse)						
Head Tracker : Forward/Backward						TRA
Head Tracker : Pitch						TRA
Head Tracker : Right/Left						TRA
Head Tracker : Roll						TRA
Head Tracker : Up/Down						TRA
Head Tracker : Yaw						TRA
Pitch				JOY_Y		
Roll				JOY_X		
Rudder					JOY_RZ	
Thrust			JOY_Z			
Wheel Brake Left					JOY_X	
Wheel Brake Right					JOY_Y	
Zoom View						

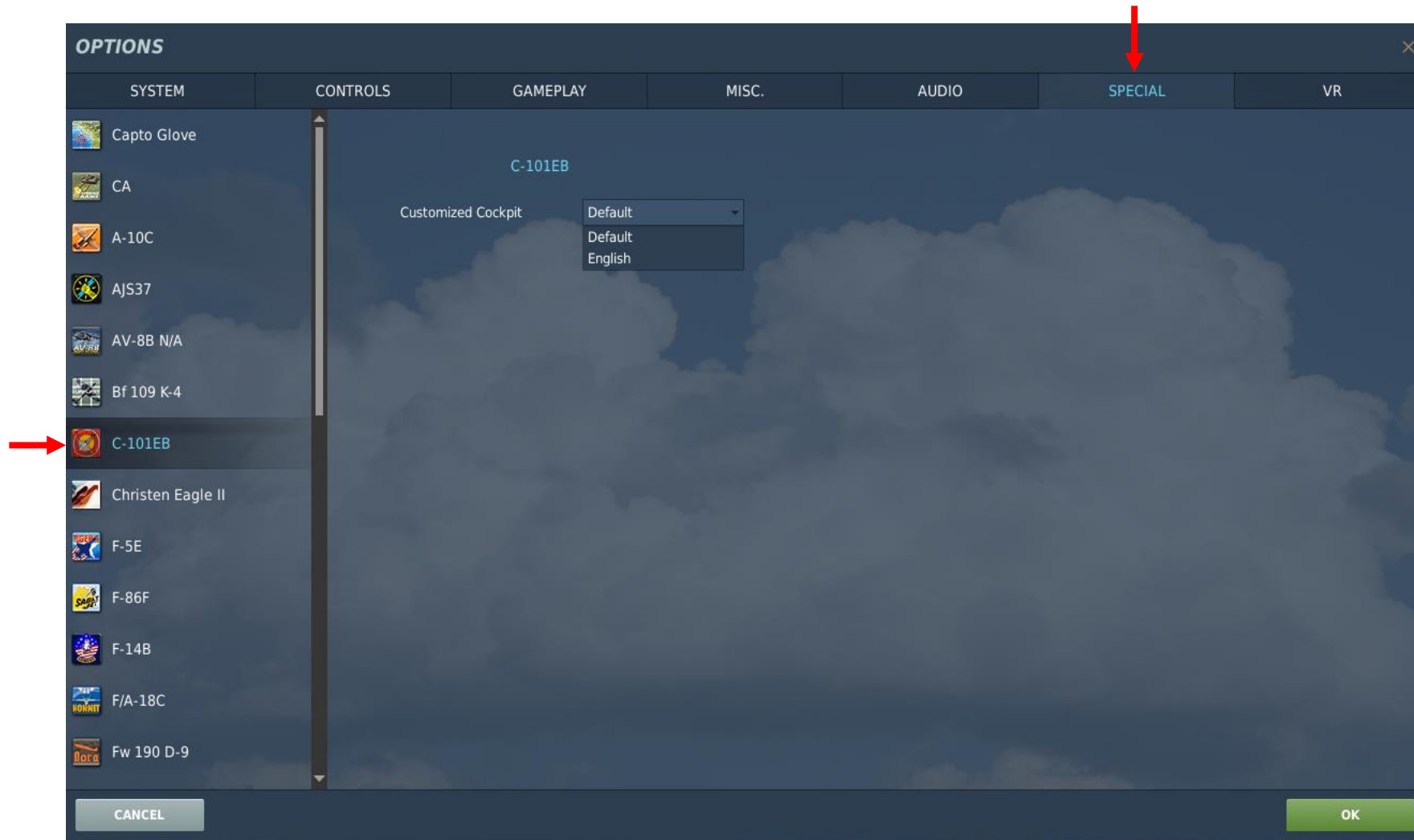
Modifiers Add Clear Default **Axis Assign** Axis Tune FF Tune Make HTML

CANCEL OK

TO ASSIGN AXIS, CLICK ON AXIS ASSIGN. YOU CAN ALSO SELECT "AXIS COMMANDS" IN THE UPPER SCROLLING MENU.

TO MODIFY CURVES AND SENSITIVITIES OF AXES, CLICK ON THE AXIS YOU WANT TO MODIFY AND THEN CLICK AXIS TUNE

In the “SPECIAL” tab, you can select your desired language for the C-101EB - Spanish (Default) or English. The C-101CC cockpit is in English by default.



WHAT YOU NEED MAPPED (C-101CC CONTROLS)

STICK GO AROUND BUTTON
(Grey button on RHS)

Stores Release Button

First Detent: Trigger Safety Catch - Unlock
Second Detent: Fixed Weapons Trigger

Stick Touch Control System (TCS) Button

Store Release Guard - Open

+ TOE BRAKES (MAPPED ON PEDALS)

↑ TRIM NOSE UP
→ TRIM RUDDER LEFT
↓ TRIM NOSE DOWN
← TRIM RUDDER RIGHT

↑ ZOOM IN SLOW
→
↓ ZOOM OUT SLOW
←

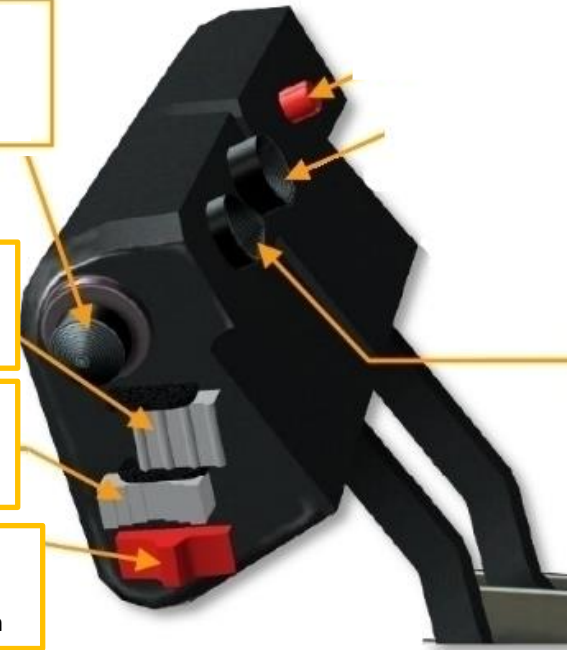
↑ Range Selector Next
→
↓ Range Selector Previous
←

↑
→ COMMUNICATION MENU (\)
↓
←

← AIRBRAKE RETRACT (LCTRL+B)
→ AIRBRAKE EXTEND (LSHIFT+B)

← NEXT FLAP DETENT (LSHIFT+F)
→ PREV FLAP DETENT (LCTRL+F)

←
→ MPR (Manual Power Reserve) Switch



C-101CC
AVIOJET

PART 3 - COCKPIT & AIRCRAFT DESCRIPTION



C-101EB
Trainer Variant



C-101CC
Attack Variant

C-101CC

Front Seat
(Student Pilot)

Rear Seat
(Instructor Pilot)



C-101CC



Press RSHIFT+P to
remove/show Pilot Body

C-101CC
Front Seat



C-101CC
AVIOJET

PART 3 - COCKPIT & AIRCRAFT DESCRIPTION

C-101CC
Front Seat



PART 3 - COCKPIT & AIRCRAFT DESCRIPTION

C-101CC
AVIOJET



C-101CC
Front Seat

Cockpit Utility / Storm Light

Flood Light Lamp

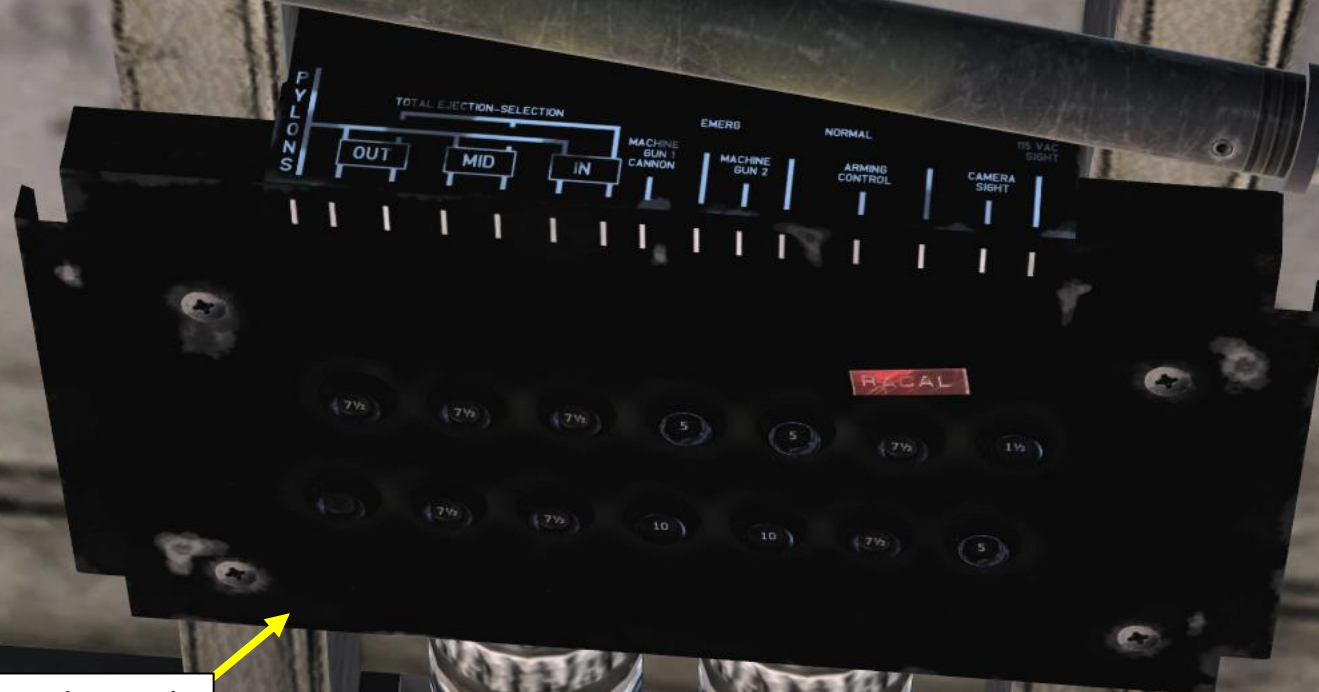


C-101CC
Front Seat



Circuit Breakers
(Cortacircuitos)

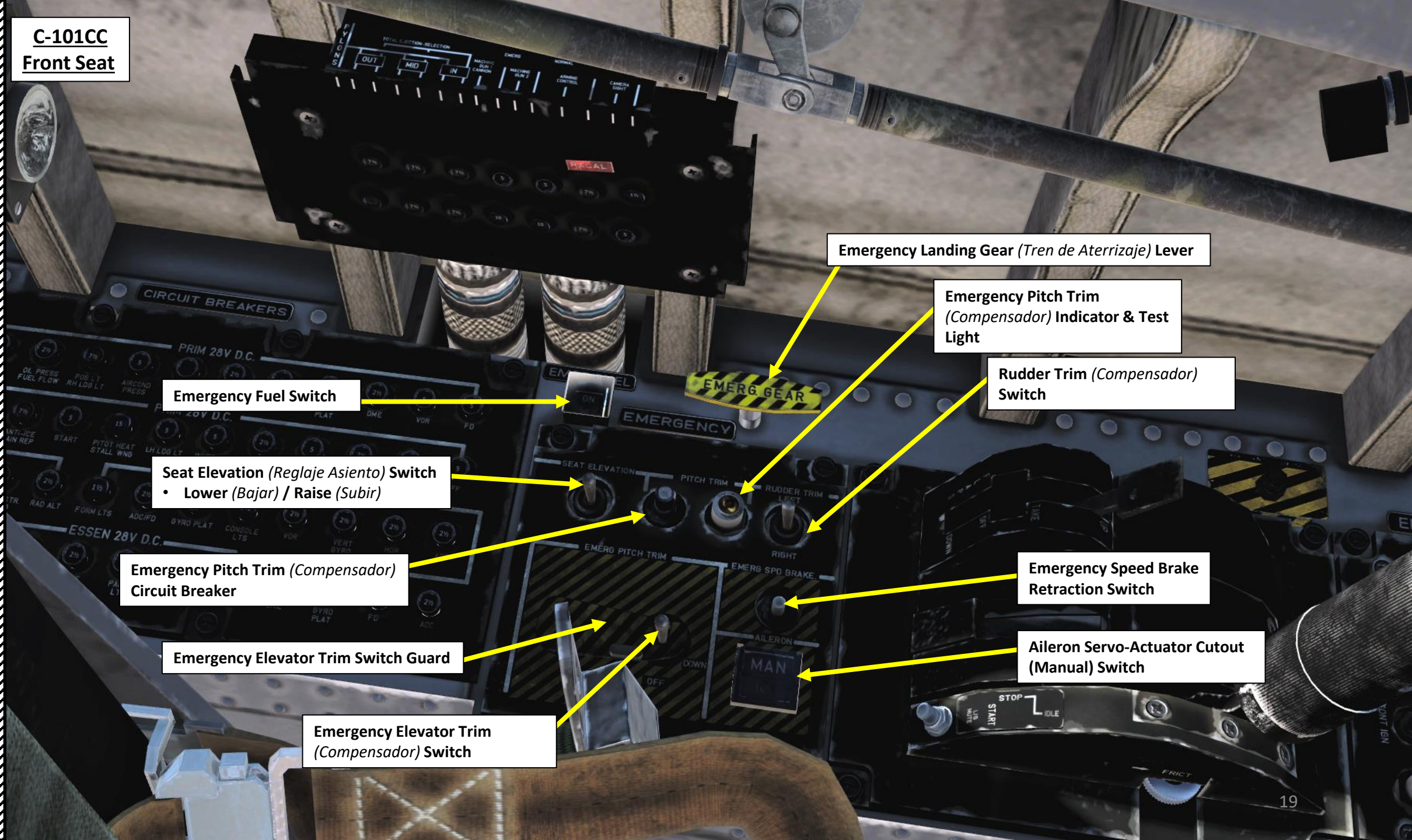
C-101CC
Front Seat



Armament Circuit Breaker Panel



C-101CC
Front Seat



Emergency Fuel Switch

Seat Elevation (Reglaje Asiento) Switch
• Lower (Bajar) / Raise (Subir)

Emergency Pitch Trim (Compensador)
Circuit Breaker

Emergency Elevator Trim Switch Guard

Emergency Elevator Trim
(Compensador) Switch

Emergency Landing Gear (Tren de Aterrizaje) Lever

Emergency Pitch Trim
(Compensador) Indicator & Test
Light

Rudder Trim (Compensador)
Switch

Emergency Speed Brake
Retraction Switch

Aileron Servo-Actuator Cutout
(Manual) Switch

C-101CC
Front Seat

Flaps Lever
Up / Takeoff / Down

Throttle (Mando de Gases)
Twist Grip controls gunsight head range selector for stadiametric target ranging.

Emergency Fuel Lever Setting Table	
Position 125 lbs/hour	Anti-Surge Valve 1/3 Open
Position 265 lbs/hour	Anti-Surge Valve Full Open
Position 440 lbs/hour	Anti-Surge Valve Full Open
Position 585 lbs/hour	Anti-Surge Valve Full Open
Position 760 lbs/hour	Anti-Surge Valve 1/3 Open
Position 895 lbs/hour	Anti-Surge Valve 1/3 Open
Position 1065 lbs/hour	Anti-Surge Valve 1/3 Open
Position 1200 lbs/hour	Anti-Surge Valve Closed

Landing Gear Aural Warning Mute Button

Throttle Friction Adjustment Wheel

Emergency Fuel Lever

**C-101CC
Front Seat**

Microphone Push-to-Talk Switch

Speed Brake (Aerofreno) Switch

- AFT: Extends Speed Brake OUT
- MIDDLE: No Speed Brake Command
- FWD: Retracts Speed Brake IN

Fuel Enrichment (Enriquecimiento) Pushbutton

MPR (Manual Power Reserve) Switch

C-101CC
Front Seat

Canopy Handle

Clock

Canopy Locking Lever
Forward = Locked



**C-101CC
Front Seat**

GPU (Ground Power Unit) Switch

- GPU: Ground power is connected to the aircraft and has power available. Aircraft electrical circuits are not energized.
- GPU ON: Ground power is connected to the aircraft and GPU switch is pressed in. Aircraft electrical circuits are energized.

Note:

A "Korry" is a type of switch named after its inventor Boris Korry. Esterline is the producer of the well known Korry switches and control devices used in most airliners and flight simulators on the market, including Airbus, Boeing and others.

Engine Starter (Arranque) Mode Selector

- Forward: **Crank** (Ventilación) Mode. Engine is motored without initiating the start sequence. Normally used to clear the residual fuel in the combustion chamber following a start failure
- Middle: **Off**
- Aft: **Normal** (Automatic) Start Mode. Engine rotation initiates when the ignition switch is held to START

Engine Abort Start Switch

- Forward: **OFF**
- Aft: **Engine Start Abort**

Engine Ignition (Ignición) Switch

- Forward: **Start** (Arranque). Hold the switch to START for approximately 2 seconds to energize the igniters and starter-generator.
- Middle: **Off**
- Aft: **Continuous Ignition** (Ignición continua). Only the igniters are energized. Use continuous ignition for takeoff, landing and during icing conditions, heavy turbulence or when flying in thunderstorms.

Ignition Light

Engine Anti-Ice (Antihielo) Switch

- ON (Korry illuminated): Engine anti-ice system is active.

Engine Computer Control Switch

- MAN (Korry illuminated): Computer operating in manual mode
- ON (Korry extinguished): Computer in automatic mode

**C-101CC
Front Seat**

Fuselage Center Fuel Tank Available Indication

- White = Circuit is de-energized.
- Green = Fuel present in the tank
- Red = No fuel present in the tank

Left Wing Fuel Tank Available Indication

- White = Circuit is de-energized.
- Green = Fuel present in the tank
- Red = No fuel present in the tank

Left Wing Fuel Transfer Pump Switch

- Aft (Manual) = Pump is energized until the switch is set to OFF
- Middle = OFF
- Forward (Auto) = Pump is energized until all the fuel in the tank is transferred

Center Tank Fuel Transfer Pump 1 Switch

- Aft (Manual) = Pump is energized until the switch is set to OFF
- Middle = OFF
- Forward (Auto) = Pump is energized until all the fuel in the tank is transferred

Center Tank Fuel Transfer Pump 2 Switch

- Aft (Manual) = Pump is energized until the switch is set to OFF
- Middle = OFF
- Forward (Auto) = Pump is energized until all the fuel in the tank is transferred

Fuel Quantity Selector Pushbutton

- FUS (Korry illuminated): Fuselage fuel tank indication only
- OFF (Korry extinguished): Fuselage and center wing fuel indication

Submerged Fuselage Fuel Tank Boost (Bomba Sumergida) Pump Switch

- OFF (Korry illuminated): Boost pump de-energized and fuel shutoff valve de-energized
- Korry extinguished: Boost pump energized and fuel shutoff valve energized

Fuel Quantity Indicator (x1000 lbs)

Indication is based on the Fuel Quantity Selector position

Fuel Shutoff Valve (Llave de Combustible) Switch

- OFF (Korry illuminated): Fuel shutoff valve de-energized
- Korry extinguished: Fuel shutoff valve energized / open

Fuel Quantity Indicator Test Switch

Transfer Pressure Indication

- White = Circuit is de-energized.
- Green = There is fuel transfer pressure
- Red = There is no fuel transfer pressure

Right Wing Fuel Tank Available Indication

- White = Circuit is de-energized.
- Green = Fuel present in the tank
- Red = No fuel present in the tank

Right Wing Fuel Transfer Pump Switch

- Aft (Manual) = Pump is energized until the switch is set to OFF
- Middle = OFF
- Forward (Auto) = Pump is energized until all the fuel in the tank is transferred

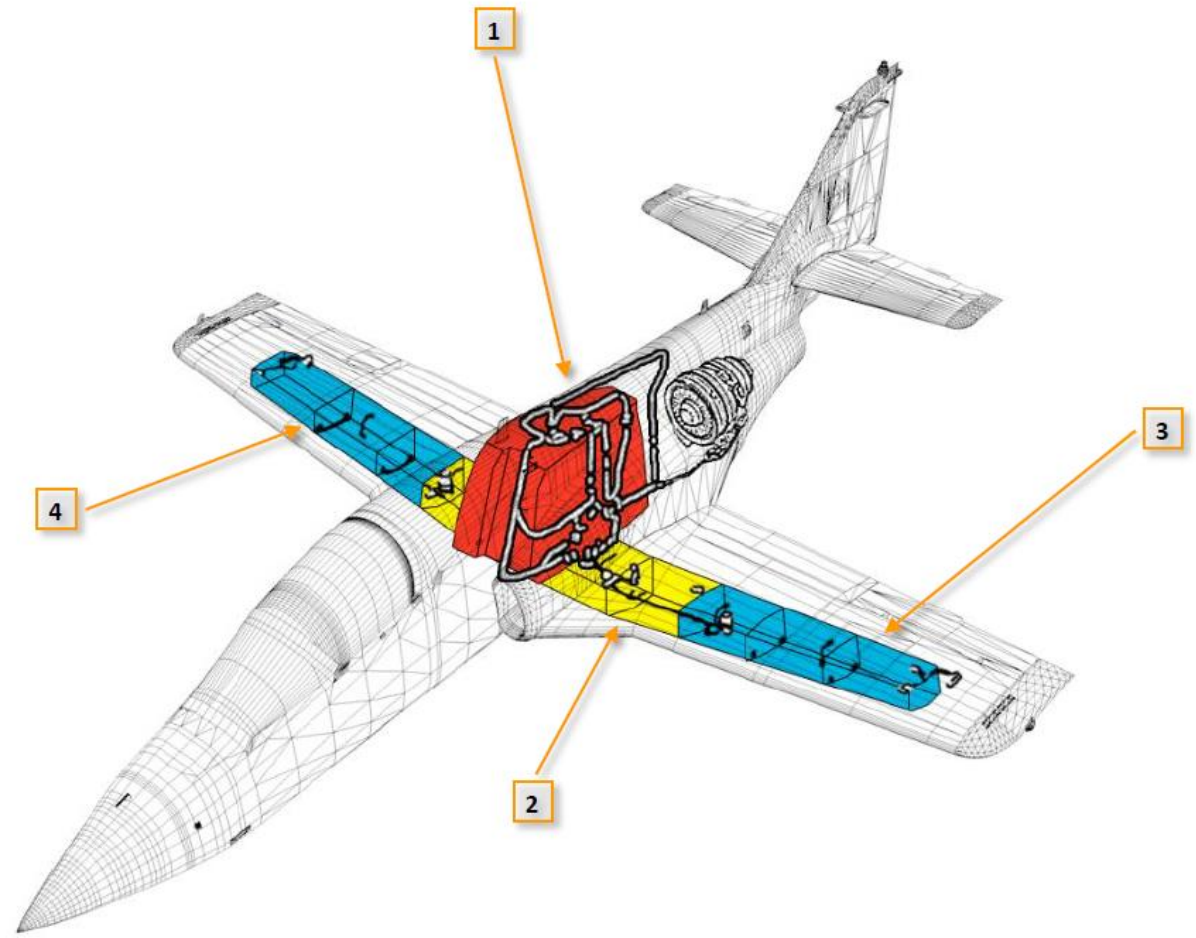
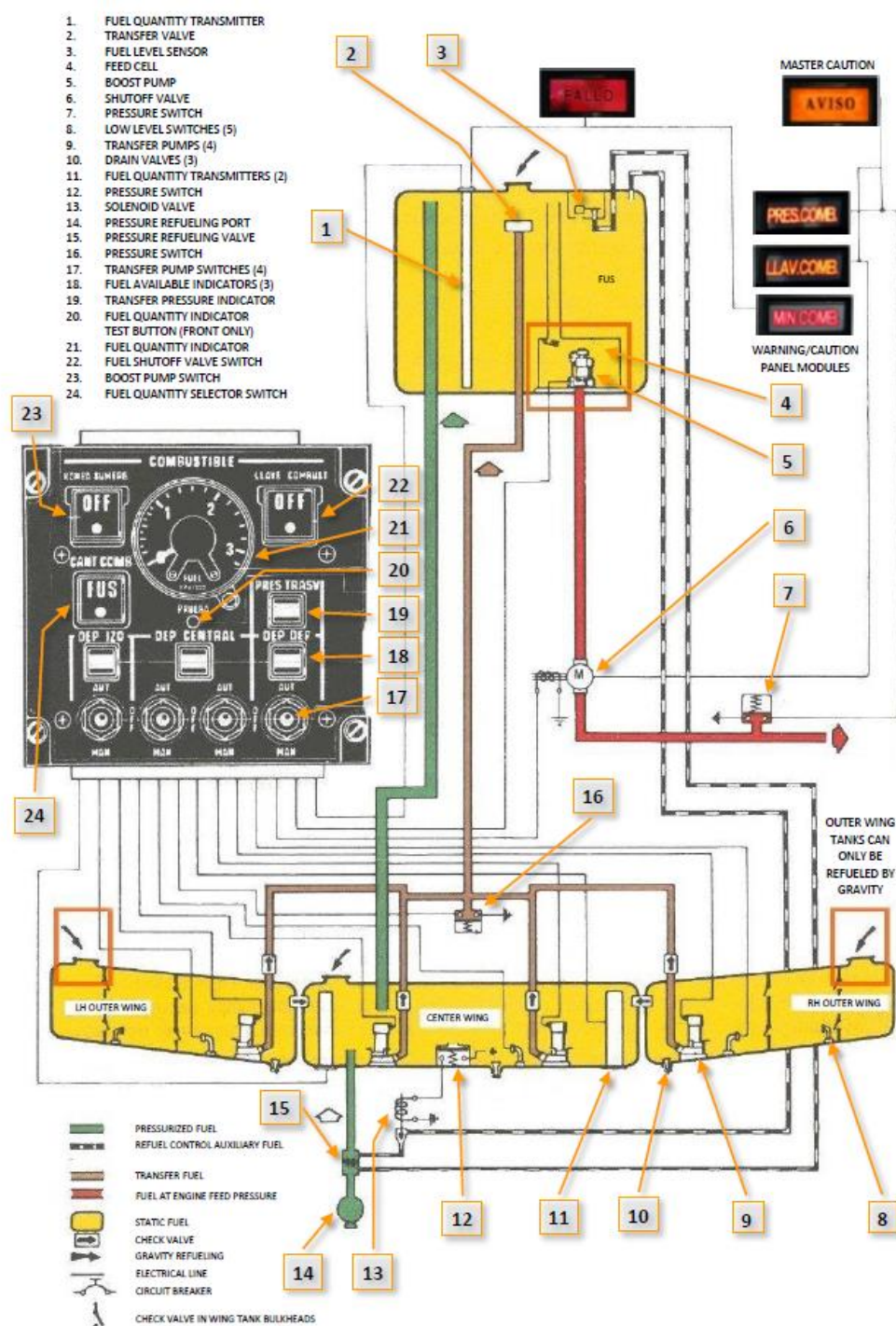


Figure 3-21 Aircraft fuel system

1 FUSELAGE TANK

3 LEFT OUTER WING TANK

2 CENTER WING TANK

4 RIGHT OUTER WING TANK

C-101CC
Front Seat

Emergency Landing Gear (Tren de Aterrizaje) Lever

Parking Brake Lever
Pulled = Engaged

AoA (Angle of Attack)
Stall Warning Test Switch

AoA (Angle of Attack) Stall
Warning Power Switch

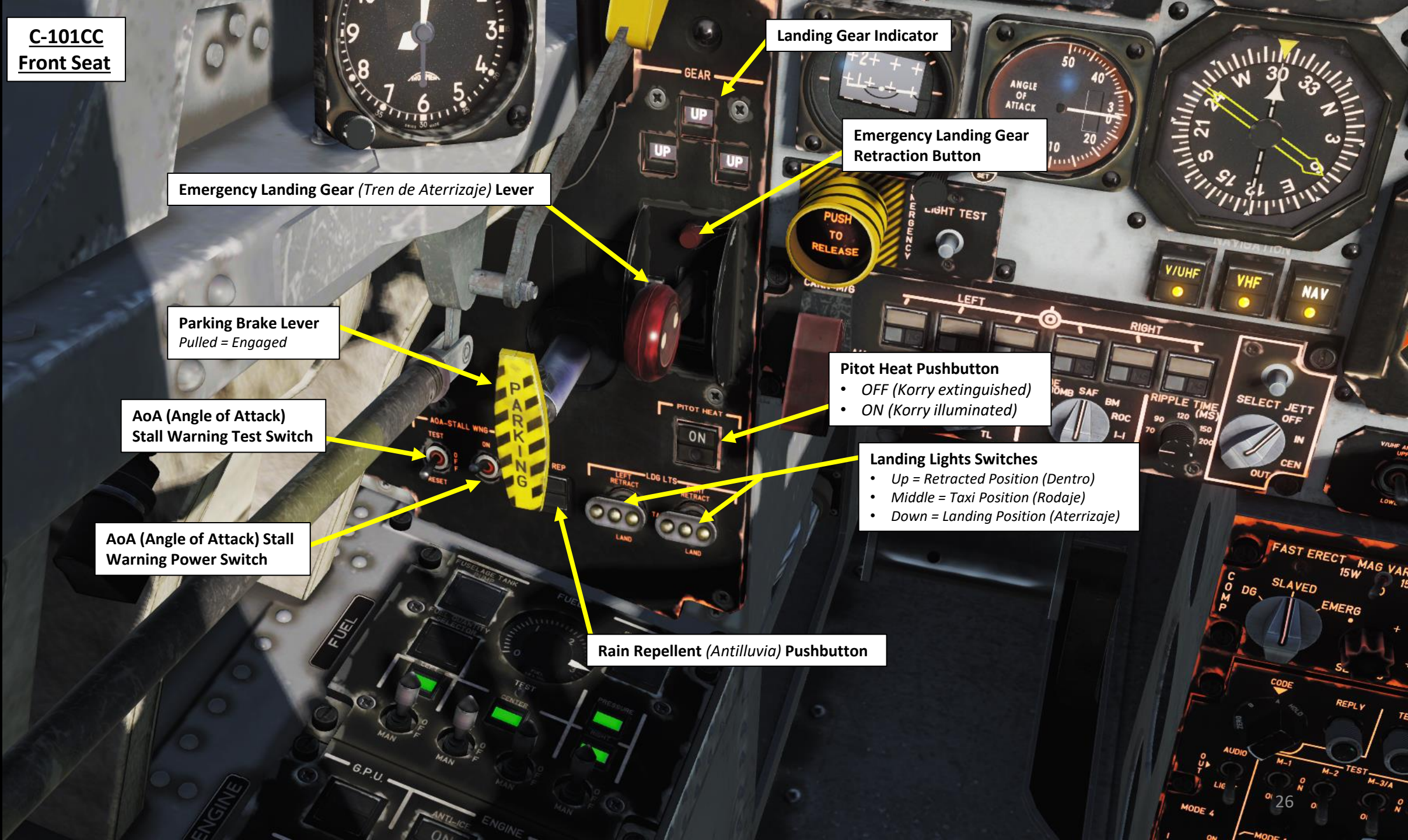
Landing Gear Indicator

Emergency Landing Gear
Retraction Button

Pitot Heat Pushbutton
• OFF (Korry extinguished)
• ON (Korry illuminated)

Landing Lights Switches
• Up = Retracted Position (Dentro)
• Middle = Taxi Position (Rodaje)
• Down = Landing Position (Aterrizaje)

Rain Repellent (Antilluvia) Pushbutton





**C-101CC
Front Seat**



**SCAR (Selection, Control and Release)
Control Unit Panel**
Tactical controls for armament systems

C-101CC Front Seat

Emergency Jettison Pushbutton

SCAR Light Test Button

Left & Right Pylon Selector / Status Indicator Pushbuttons

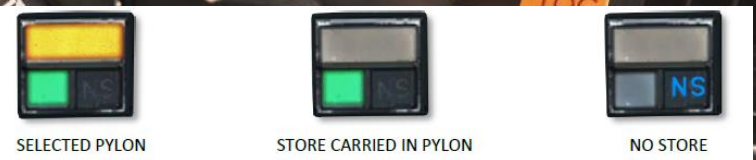


Figure 9-40 Pylon Selector/Status Indicator Buttons

Fixed Weapons Switch & Cover Guard (Cannon - Machine Gun)

- A/A (Up): Air-to-air mode
- OFF (Middle)
- A/G (Down): Air-to-Ground mode

Weapons Master Switch

Bomb Arming Selector

- OFF: Disarmed
- NS/TL: Nose/Tail Fuze Armed
- NS: Nose Fuze Armed
- TL: Tail Fuze Armed

Weapon Mode Selector

- SAF (Safe): Bomb & rockets disarmed, but emergency jettison system remains operative
- BOMB: Stores can be released from pylons pre-selected by the pylon selector/ status indicators. If one pylon is selected only the stores from that pylon will be released, if more than one pylon is selected the bombs will be released in pairs from the pylons in the following order: inboard, outboard and center
- RIP (Ripple): Stores are released with a time delay set on the ripple time selector
- NC (No Function): Used when using air-to-air IR missiles
- BM (Bombs, Mixed Launcher): Bomb release when mixed launcher is fitted to pylon
- ROC (Rocket, Mixed Launched): Rocket release when mixed launcher is fitted to pylon
- 1-1 (Single Rockets): Single rocket release mode
- BRST (Multiple Rockets): Multiple rocket release mode

Selective Jettison Button

Selective Jettison Selector

- OFF
- Inboard Pylons
- Center Pylons
- Outboard Pylons

Ordnance Ripple Time Selector (milliseconds)
70 / 90 / 120 / 150 / 200 ms

**C-101CC
Front Seat**

Warning (Falto) Light

Rudder Trim Indicator

Aileron Trim Indicator

Elevator Trim Indicator

Standby Airspeed Indicator (knots)

Airbrake IN Position Indication

Airbrake OUT Position Indication

Flaps UP Position Indication

Flaps TAKEOFF Position Indication

Flaps DOWN Position Indication

VMO (Maximum Operating Speed)

Mach Indicator

Inner Marker Light (White)
Press to test, turn to dim

Middle Marker Light (Amber)
Press to test, turn to dim

Outer Marker Light (Blue)
Press to test, turn to dim

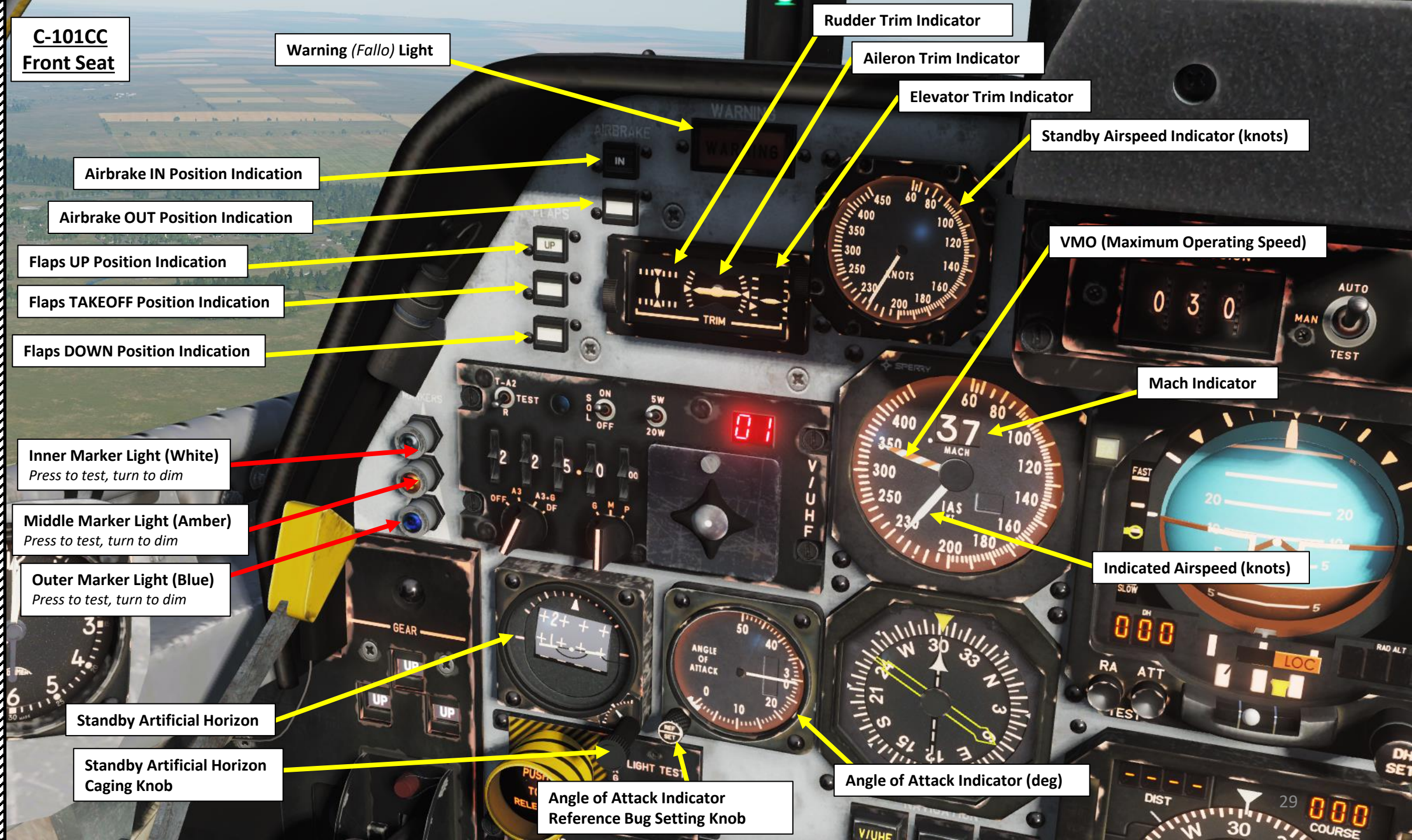
Indicated Airspeed (knots)

Standby Artificial Horizon

Standby Artificial Horizon
Caging Knob

Angle of Attack Indicator
Reference Bug Setting Knob

Angle of Attack Indicator (deg)



C-101CC
Front Seat

V/UHF Radio Indicator Test Light

V/UHF Radio Test
Selector Switch

V/UHF Radio
Squelch Switch

V/UHF Radio Power Transmit Selector

V/UHF Radio Preset Channel Indicator

V/UHF Radio Manual
Frequency Selectors

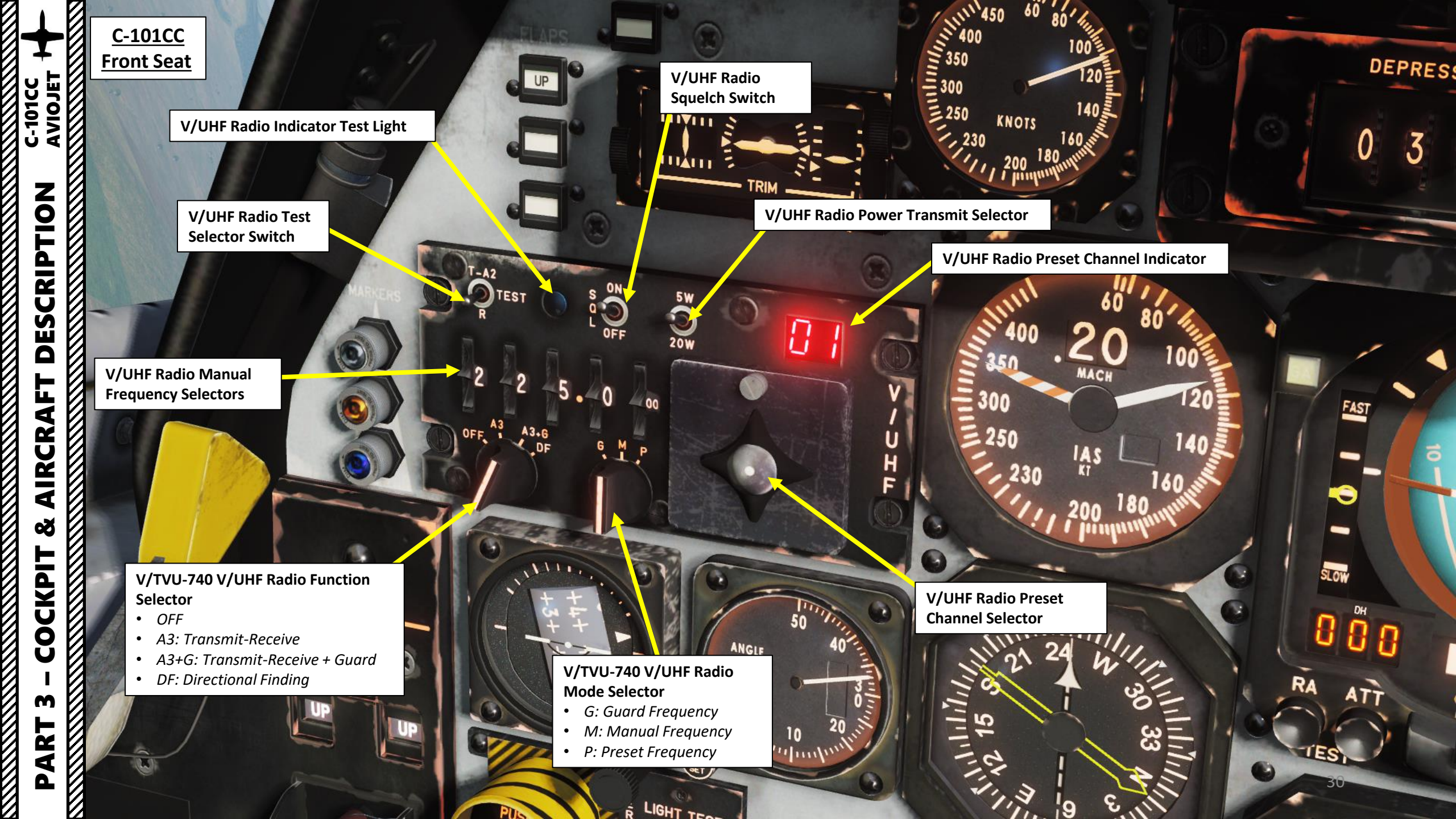
V/TVU-740 V/UHF Radio Function
Selector

- OFF
- A3: Transmit-Receive
- A3+G: Transmit-Receive + Guard
- DF: Directional Finding

V/TVU-740 V/UHF Radio
Mode Selector

- G: Guard Frequency
- M: Manual Frequency
- P: Preset Frequency

V/UHF Radio Preset
Channel Selector





Gunsight Brightness Control

Optical Sight Control Unit Depression Angle Selector Wheels & Indicator (mrad)

Optical Sight Control Unit Mode Selector
Auto / Manual / Test

Optical Sight Control Unit Power Switch

**C-101CC
Front Seat**

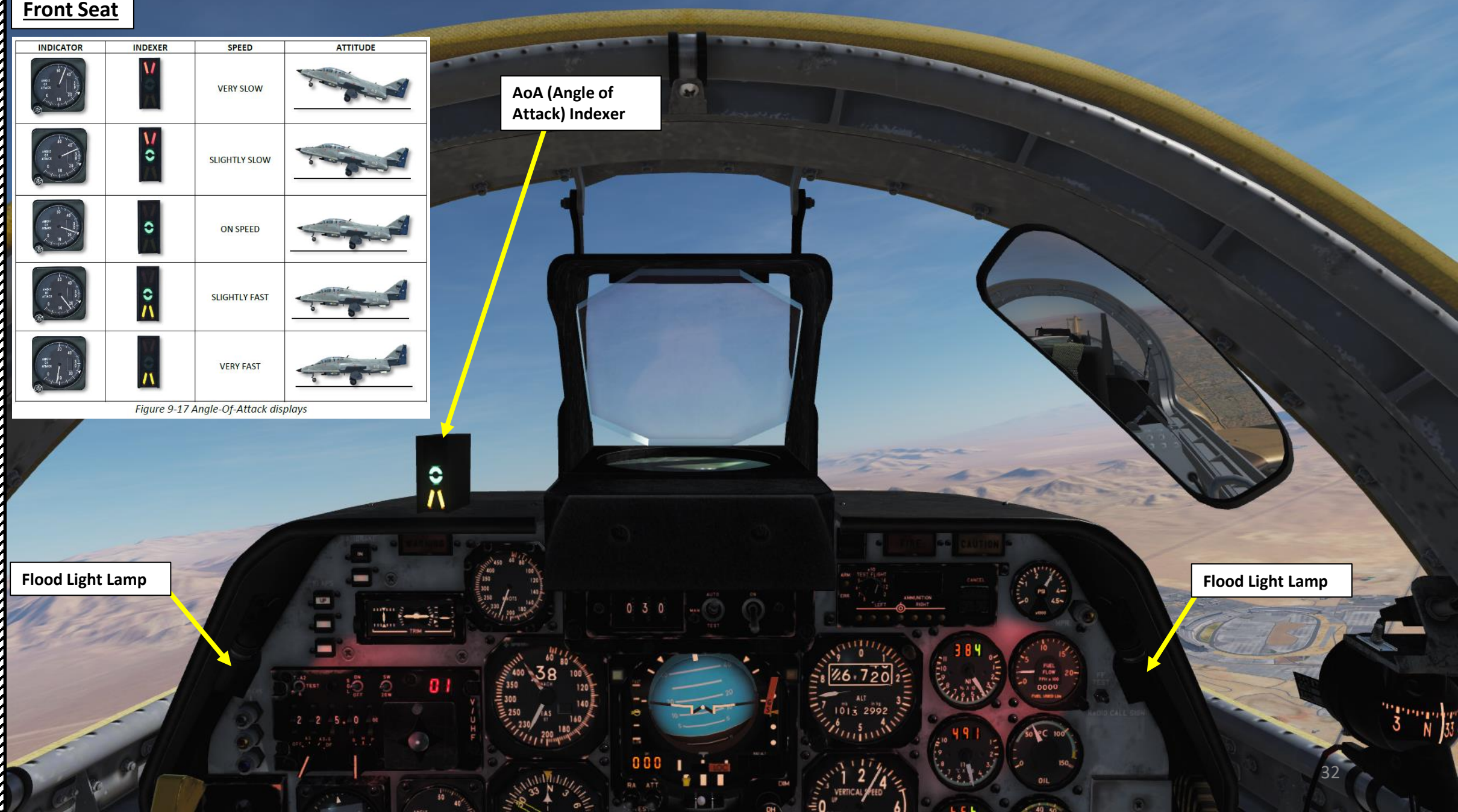
INDICATOR	INDEXER	SPEED	ATTITUDE
		VERY SLOW	
		SLIGHTLY SLOW	
		ON SPEED	
		SLIGHTLY FAST	
		VERY FAST	

Figure 9-17 Angle-Of-Attack displays

AoA (Angle of Attack) Indexer

Flood Light Lamp

Flood Light Lamp



C-101CC Front Seat

SCAR Initial Cannon Load Switch

set to indicate the number of rounds of ammunition initially loaded into the cannon ammunition box. The switch is numbered 5, 6, 7, 8, 9, 10, 12 and 14 to indicate the number of rounds x 10. The switch is also labeled TEST and FLIGHT. When set to TEST the rounds remaining readout is displayed on the ammunition remaining indicator even when the MAST SW is OFF. This permits the remaining rounds to be checked on the ground with the armament system off. The switch must be placed to FLIGHT position during flight.

Anti-Skid Switch & Indicator Light

Engine Fire (Fuego) Light

Cannon Ammunition Rounds Remaining

Caution (Aviso) Light

Hydraulic Pressure Indicator (x1000 psi)

MPR (Manual Power Reserve) Indicator Light

SCAR Selected Pylon Indicator

SCAR DU Bomb Arming Indication

SCAR ERR (Selection Error) Indication

SCAR DU (Selection, Control and Release Display Unit)



SCAR Cancel Pushbutton / Mode Selected Indicator



**C-101CC
Front Seat**



ITT (Inter-Turbine Temperature, x100 deg C) Indicator

N1 (Low Pressure Compressor Speed, x10 %RPM) Indication

Compass Light Switch

Fuel Flow Indicator (x100 lbs/hour)

Fuel Used Totalizer (lbs)

Fuel Used Totalizer Reset Button

Fuel Flow Test Button

Magnetic Compass

Oil Temperature Indicator (deg C)

Oil Pressure Indicator (psi)

DC Voltmeter (Volts)

Accelerometer (G)

Accelerometer Reset Button

Standby Altimeter (ft)

N2 (High Pressure Compressor Speed, x10 %RPM) Indicator

Vertical Speed Indicator (x1000 ft/min)

Barometric Pressure Setting Knob

Barometric Pressure (mbar / in Hg)

Altimeter (ft)

Altitude Alert Annunciator Light (Inoperative)

C-101CC
Front Seat



Cabin Air Vent

Canopy Detachment Handle

Flight Director Mode Selectors

HDG: Heading Mode	NAV: Navigation Mode	APR: Approach Mode	BC: Back Course Mode	VOR APR: VOR Approach Mode
ALT: Altitude Mode	GA: Go Around Mode (Shown on ADI)	VS: Vertical Speed Hold Mode	IAS: Indicated Airspeed Mode	SBY: Standby Mode



FD (Flight Director) Panel
Brightness Switch

C-101CC
Front Seat

Gyroscopic System Failure Flag

RMI Heading Reference Index
(Your Current Heading)

RMI Single Pointer (ADF)

RMI Double Pointer (VOR)



Figure 3-81 RMI

RMI (Radio-Magnetic Indicator)

V/UHF Transfer Pushbutton

- Transfers V/UHF Radio control to/from either front or rear cockpit.
- Korry Illuminated: your cockpit has V/UHF radio control.

VHF Transfer Pushbutton

- Transfers VHF Radio control to/from either front or rear cockpit.
- Korry Illuminated: your cockpit has VHF radio control.

NAV Transfer Pushbutton

- Transfers VOR navigation equipment control to/from either front or rear cockpit, including vertical gyro fast erection control, AHRS operation selector control and HSI remote control.
- Korry Illuminated: your cockpit has VOR & navigation system control.

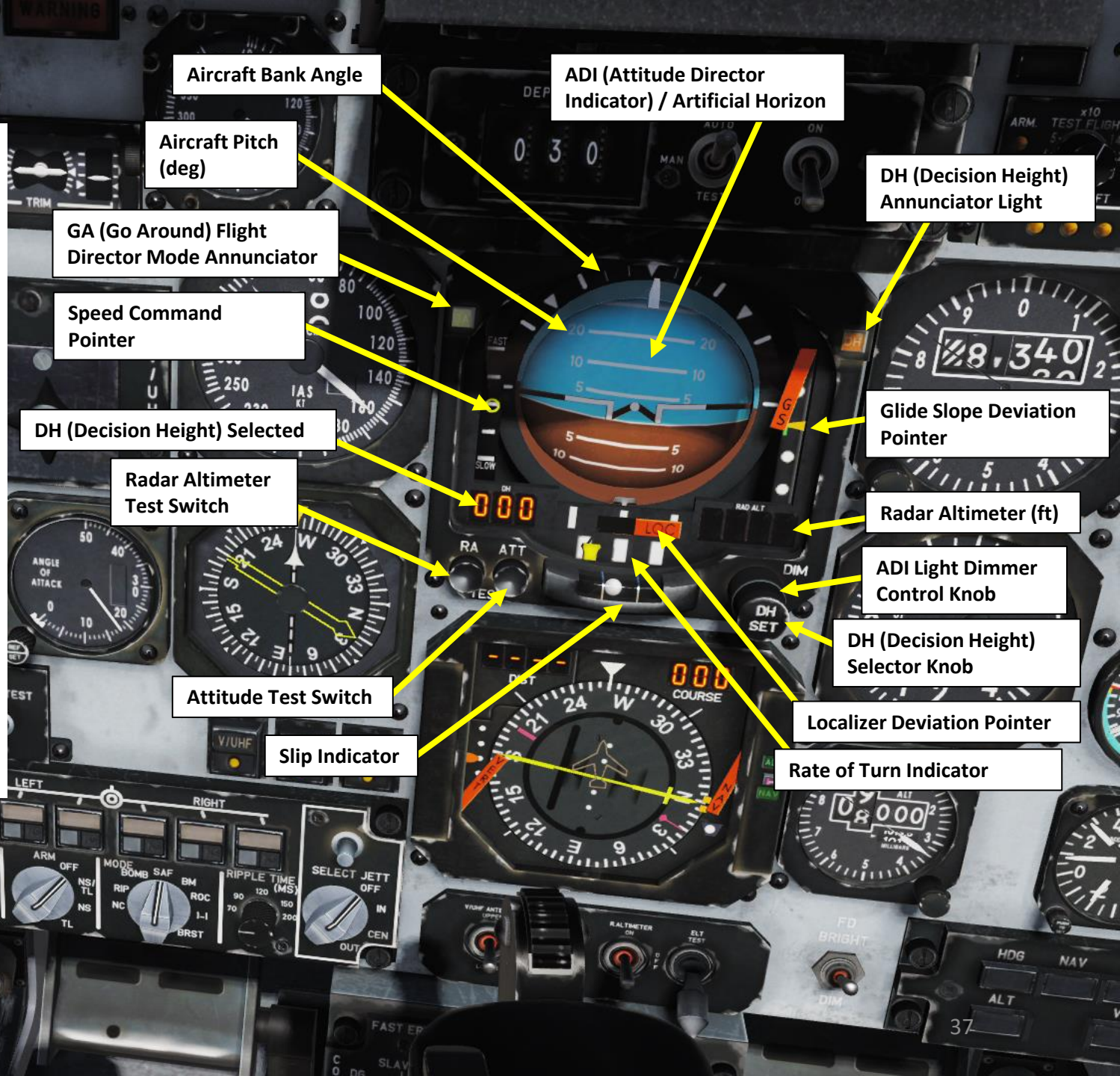
C-101CC Front Seat

Attitude Director Indicator (ADI)

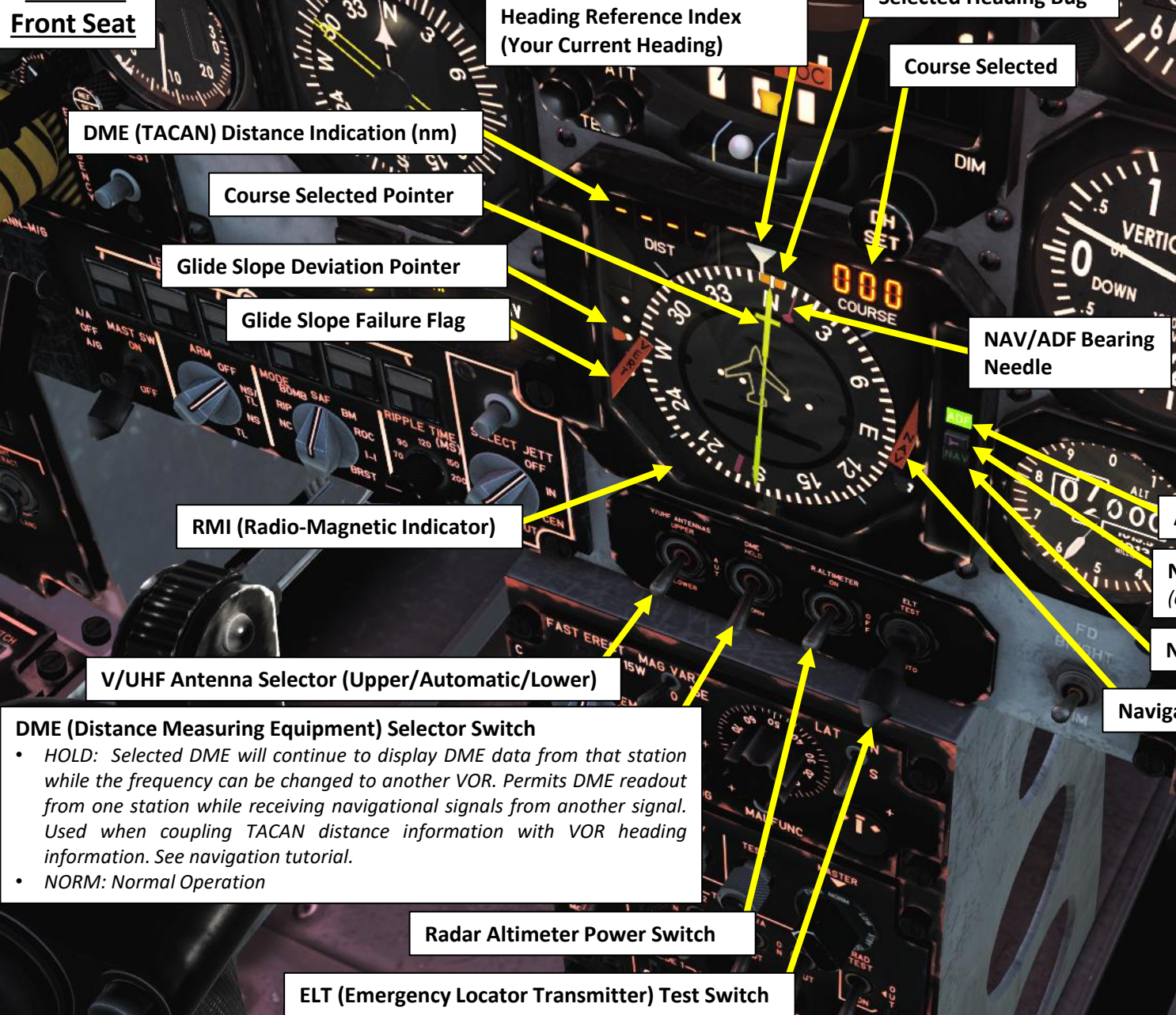


Figure 9-24 Attitude Director Indicator

- | | |
|------------------------------|--|
| 1 GO-AROUND MODE ANNUNCIATOR | 8 DECISION HEIGHT SET KNOB AND DIM CONTROL |
| 2 SPEED COMMAND POINTER | 9 RATE OF TURN POINTER |
| 3 RISING RUNWAY | 10 RADIO ALTITUDE DISPLAY |
| 4 DECISION HEIGHT DISPLAY | 11 LOCALIZER WARNING FLAG |
| 5 RATE OF TURN WARNING FLAG | 12 GLIDE SLOPE WARNING FLAG |
| 6 RADIO ALTITUDE TEST SWITCH | 13 DH ANNUNCIATOR |
| 7 ATTITUDE TEST SWITCH | |



**C-101CC
 Front Seat**



DME (TACAN) Distance Indication (nm)

Course Selected Pointer

Glide Slope Deviation Pointer

Glide Slope Failure Flag

RMI (Radio-Magnetic Indicator)

V/UHF Antenna Selector (Upper/Automatic/Lower)

DME (Distance Measuring Equipment) Selector Switch

- HOLD: Selected DME will continue to display DME data from that station while the frequency can be changed to another VOR. Permits DME readout from one station while receiving navigational signals from another signal. Used when coupling TACAN distance information with VOR heading information. See navigation tutorial.*
- NORM: Normal Operation*

Radar Altimeter Power Switch

ELT (Emergency Locator Transmitter) Test Switch

Heading Reference Index (Your Current Heading)

Selected Heading Bug

Course Selected

NAV/ADF Bearing Needle

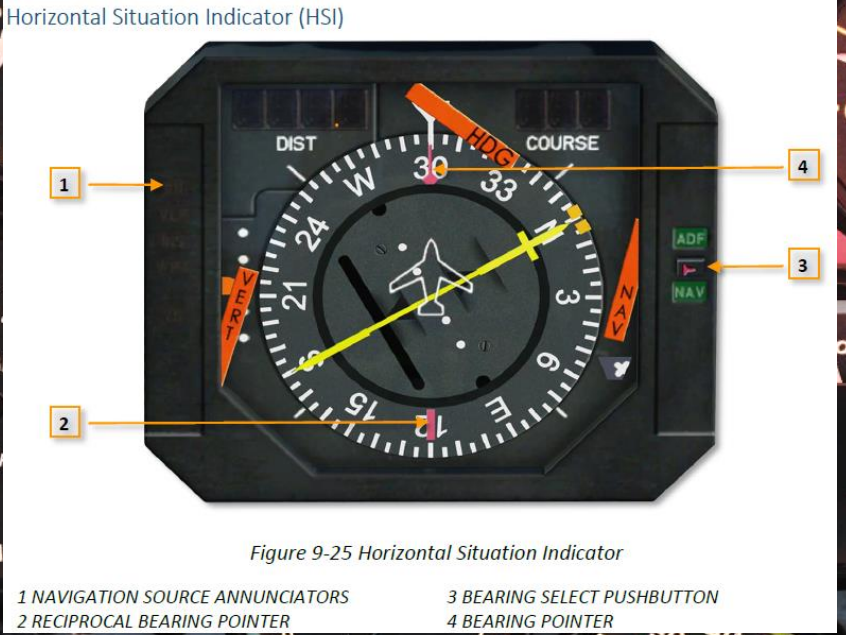


Figure 9-25 Horizontal Situation Indicator

- 1 NAVIGATION SOURCE ANNUNCIATORS
- 2 RECIPROCAL BEARING POINTER
- 3 BEARING SELECT PUSHBUTTON
- 4 BEARING POINTER

ADF (Automatic Direction Finder) Bearing Selected Light

NAV/ADF Bearing Selector Toggle Switch (alternates between ADF and NAV)

NAV (VOR) Bearing Selected Light

Navigation Failure Flag

**C-101CC
Front Seat**

Gyroscope Fast Erect Pushbutton

Gyro Magnetic Variation Control Switch

Synchroniser and Heading Set

Gyro Latitude Correction Control Wheel

Gyro Hemisphere Selector Switch (North/South)

Gyro Synchronization Indicator

AS-339 AHRS (Attitude & Heading Reference System) Control Panel
 The C101-CC's Attitude and Heading Reference System (AHRS) components consist of a Gyroscope Reference Unit (GRU), an Electronic Control Amplifier (ECA) and a Gyro Platform Control Panel which is located on the pedestal of the front cockpit. A Flux Valve, located in the right wing tip, provides magnetic heading to the system. The C-101 EB, on the other hand, uses the older TARSYN 333 system.

Gyro Malfunction Warning Lamp

IFF (Identify-Friend-or-Foe) Master Switch

- Emergency
- Normal
- Low
- Standby
- OFF

Rudder Pedal Adjustment Handle

Compass Function Selector

- DG: Directional Gyro
- SLAVED
- EMERGENCY

AN/APX-101 IFF (Identify-Friend-or-Foe) Transponder Control Panel (Not Simulated)

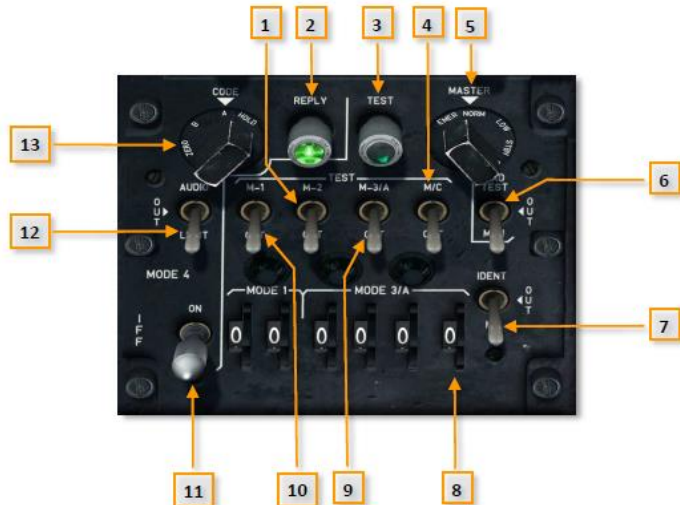
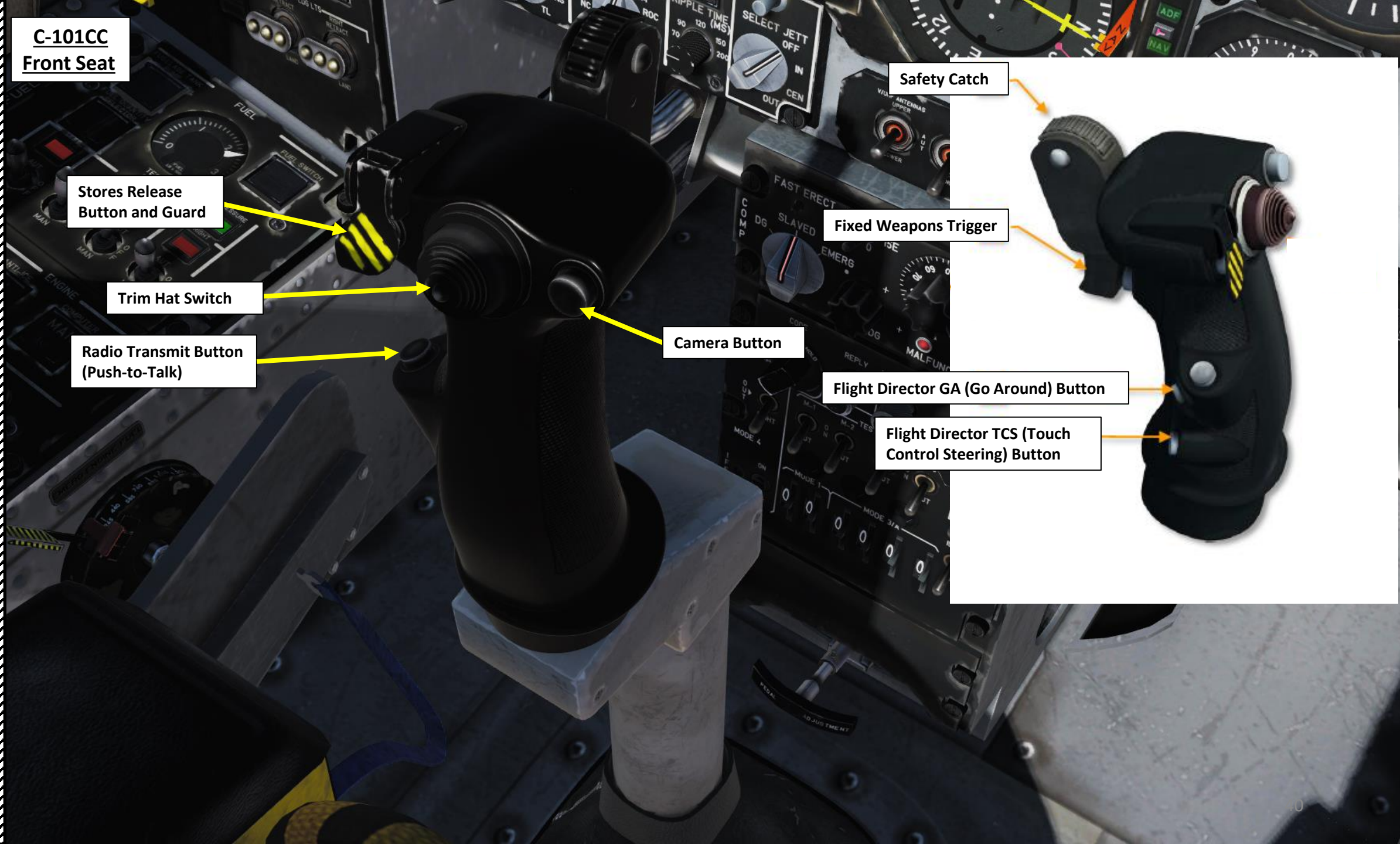


Figure 3-82 IFF panel

- | | |
|--------------------------|----------------------------|
| 1 MODE 2 SELECTOR SWITCH | 8 3/A CODE SELECTORS |
| 2 INOPERATIVE | 9 MODE 3/A SELECTOR SWITCH |
| 3 TEST LIGHT | 10 MODE 1 SELECTOR SWITCH |
| 4 MODE C SELECTOR SWITCH | 11 INOPERATIVE |
| 5 MASTER SWITCH | 12 INOPERATIVE |
| 6 TEST SWITCH | 13 INOPERATIVE |
| 7 IDENT SWITCH | |

C-101CC
Front Seat



Stores Release Button and Guard

Trim Hat Switch

Radio Transmit Button (Push-to-Talk)

Camera Button

Safety Catch

Fixed Weapons Trigger

Flight Director GA (Go Around) Button

Flight Director TCS (Touch Control Steering) Button

C-101CC
Front Seat

Ejection Seat Firing Handle



C-101CC
Front Seat

Warning/Caution (Aviso de Fallos) Panel Brightness Switch

- UP: Bright (*Brillo*)
- DOWN: Dim (*Tenue*)

Essential Bus Transfer (Transferencia de la Barra Esencial) Switch with Cover Guard

Bus Tie (Unión de Barras) Switch

- UP: ON
- DOWN: OFF

Left Battery Isolation Switch with Cover Guard

Battery Master (Batería) Switch

- UP: ON
- DOWN: OFF

Warning/Caution (Aviso de Fallos) Panel Test (Prueba) Switch

Inverter (Convertidor) Switch

- UP: Normal
- MIDDLE: OFF
- DOWN: Standby (*Reserva*)

Generator (Generador) Switch

- UP: ON
- MIDDLE: OFF
- DOWN: Reset

Generator Test (Prueba de Fallo de Generador) Switch

- UP: GF (Ground Fault / *Fallo de Masa*) Test
- MIDDLE: OFF
- DOWN: OV (Overvoltage / *Sobrevoltaje*) Test

Right Battery Isolation Switch with Cover Guard



Battery de-energized



Battery disconnected



Battery reached 57°C

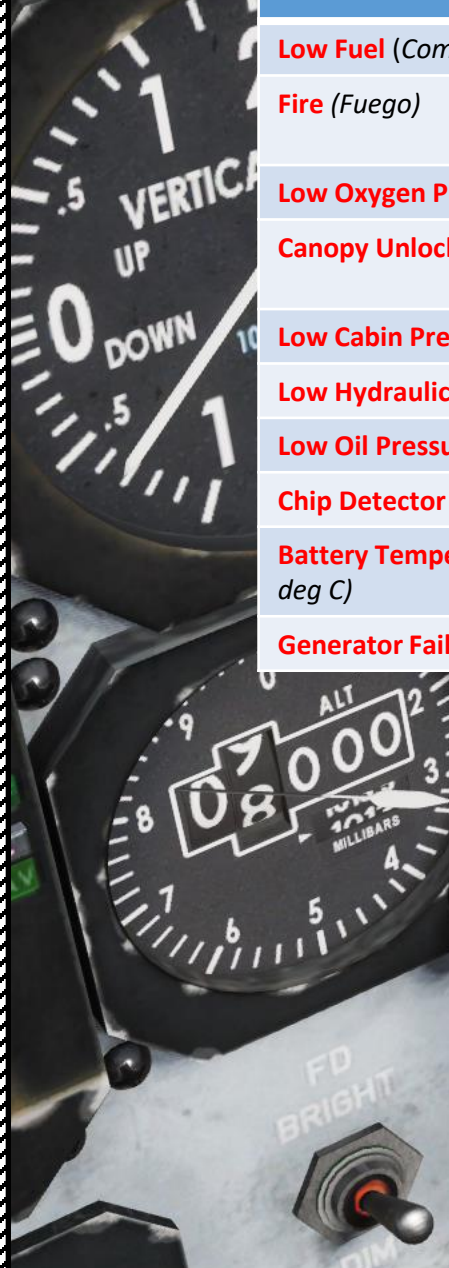
CAWS (Caution & Warning System) Panel (Central de Aviso de Fallos)

Low Fuel (Combustible Mínimo)	Low Fuel Pressure (Presión Combustible)
Fire (Fuego)	Fuel Valve (Llave Combustible): Fuel shutoff valve is not fully open
Low Oxygen Pressure (Presión Oxígeno)	Air Conditioning Failure (Acondicionamiento)
Canopy Unlocked (Blocaje Cabina)	Landing Gear Warning (Tren): Gear strut is not down and locked below 6500 ft and 75 % N1
Low Cabin Pressure (Presión Cabina)	Pitot Heat Failure (Calefacción Pitot)
Low Hydraulic Pressure (Presión Hidráulica)	Computer Failure (Fallo Computador)
Low Oil Pressure (Presión Aceite)	Anti-Ice Failure (Antihielo)
Chip Detector (Partículas Metálicas)	AoA (Angle of Attack)/Stall (Aviso Pérdida)
Battery Temperature at 70 deg C (Batería a 70 deg C)	Normal Inverter Failure (Convertidor Normal)
Generator Failure (Generador)	Standby Inverter Failure (Convertidor Reserva)

CAWS (Caution & Warning System) Panel (Central de Aviso de Fallos)



MIN.COMB	PRES.COMB.	LOW FUEL	FUEL PRESSURE
FUEGO	LLAV.COMB.	FIRE	FUEL VALVE
PRES.OXIG	ACOND.T.	OXYGEN PRESSURE	AIR CONDITIONING
BLOCC.CAB	TREN▲	CANOPY UNLOCKED	GEAR
PRES.CAB	CAL.PITOT	COCKPIT PRESSURE	PITOT HEAT
PRES.HDR	COMPUT.	HYDRAULIC PRESSURE	COMPUTER FAILURE
PRES.ACTE	ANTIHELO	OIL PRESSURE	ANTI-ICE
	AVIS.PERD.	CHIP DETECTOR	STALL
70°BAT	CONV.NOR.	70° BATTERY	NORMAL INVERTER
X.GEN.C.C	CONV.RVA.	GENERATOR	STANDBY INVERTER



C-101CC
Front Seat

Cabin Pressure Altitude Indicator (x1000 ft)

Oxygen Flow Front (Posterior) Seat Indicator

Oxygen Flow Front (Anterior) Seat Indicator

Oxygen Pressure Indicator (x100 psi)

Instruments Lighting Adjustment Knob (Iluminación de Instrumentos)
• Dim (Tenue) / Bright (Brillo)

Formation Lights (Luces de Formación) Switch
• UP: Bright (Brillo)
• MIDDLE: OFF
• DOWN: Dim (Tenue)

Anti-Collision Light (Luz de Anticolisión) Switch
• FWD: ON
• AFT: OFF

Navigation Lights (Luces de Navegación/Posición) Switch
• UP: Bright (Brillo)
• MIDDLE: OFF
• DOWN: Dim (Tenue)

Flood Lights (Luces Auxiliares/Alumbrado) Switch
• UP: Bright (Brillo)
• MIDDLE: OFF
• DOWN: Dim (Tenue)

Cabin/Storm Lights (Luces de Cabina/Tormenta) Switch
• FWD: ON
• AFT: OFF

Console Lighting Adjustment Knob (Iluminación de Consolas)
• Dim (Tenue) / Bright (Brillo)

**C-101CC
Front Seat**

Telebriefing Light
When illuminated, telebriefing allows confidential briefing information from the operations controller to be given to the pilot via a closed landline whilst the aircraft is at the platform. Communication with telebriefing personnel is accomplished through a connector located on the right main gear door.

Oxygen Valve Lever
• Fwd: Open
• Aft: Closed



Navigation Radio Frequency Setting & Volume Control Knob
(Scroll mousewheel to set channel, click to set volume)

Navigation Radio Frequency Indicator

Navigation Radio Frequency Setting & Mode Control Knob
(Scroll mousewheel to set channel, click to set mode)
• OFF / NAV / STANDBY / DME / OVERRIDE

Navigation Equipment Selector
VOR: VHF Omnidirectional Range
DME: Distance Measuring Equipment

VHF Radio Frequency Setting & Volume Control Knob
(Scroll mousewheel to set channel, click to set volume)

VHF Radio Frequency Indicator

VHF Radio Frequency Setting & Mode Control Knob
(Scroll mousewheel to set channel, click to set mode)
• OFF / POWER / TEST

Audio Select Control Selectors
(Raised = ON, Rotate to set volume)
• Intercom / VHF / ADF / VOR / Hot Mic / DME / Marker / V/UHF

Hot Mic (Talk) Circuit Breaker
(Raised = ON)

Selected Heading Bug

Call Button

HSI (Horizontal Situation Indicator) Heading Bug Control Knob

HSI (Horizontal Situation Indicator) Course Setting Bug Control Knob

Intercom Mode (Biscuit) Selector Switch
V/UHF, VHF, Intercom

Intercom Volume Control Knob

C-101CC Front Seat

ADF 2 Frequency Tuning Knobs

- Upper Knob: Hold Right Click + Scroll mousewheel
- Middle Knob: Scroll mousewheel
- Lower Knob: Hold Left Click + Scroll mousewheel

ADF 1 Frequency Indicator

ADF Transfer Switch

ADF Tone Switch

- ON / OFF

ADF 2 Frequency Indicator

ADF 1 Frequency Tuning Knobs

- Upper Knob: Hold Right Click + Scroll mousewheel
- Middle Knob: Scroll mousewheel
- Lower Knob: Hold Left Click + Scroll mousewheel

ADF (Automatic Direction Finder) Mode Selector (Left/Right Click) & Gain Control (Scroll Mousewheel)

- OFF / Antenna / ADF / Test

Air Conditioning Selector Switch

- ON / OFF / RESET

Cockpit Temperature Control Mode Selector

- Automatic / Manual

Cockpit Temperature Selector

Manual Cockpit Temperature Control

Air Flow Selector (Cockpit / Windshield)

Emergency Ventilation Switch

C-101CC
Front Seat

Canopy Fracturing Handle



PART 3 – COCKPIT & AIRCRAFT DESCRIPTION

**C-101CC
AVIOJET**

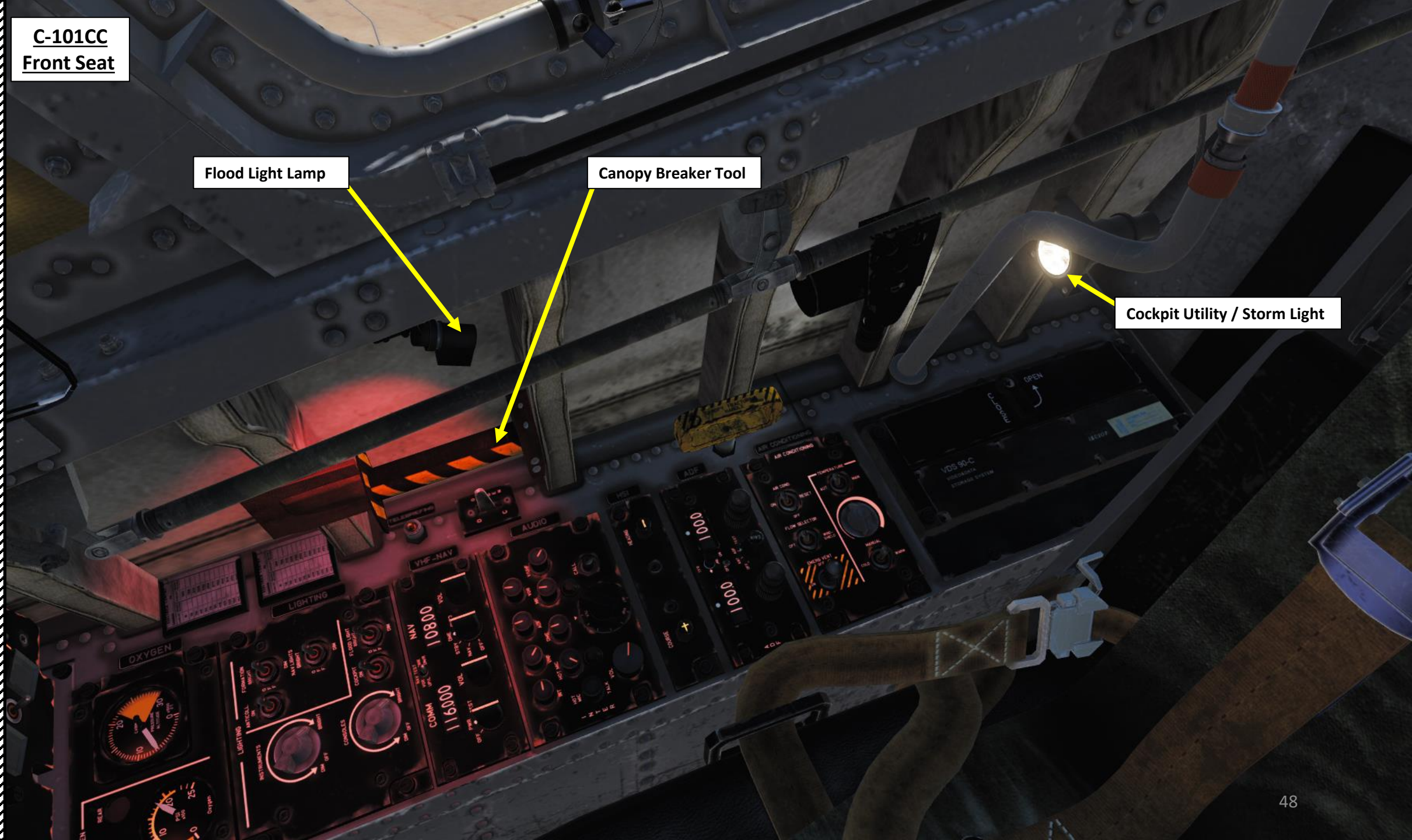


**C-101CC
Front Seat**

Flood Light Lamp

Canopy Breaker Tool

Cockpit Utility / Storm Light



C-101CC
Rear Seat



C-101CC
Rear Seat



C-101CC
Rear Seat

Circuit Breakers
(Cortacircuitos)





C-101CC
Rear Seat



C-101CC
Rear Seat



C-101CC
Rear Seat



C-101CC
Rear Seat



Gyro Platform Fast Erect Switch

DME Hold Switch

HSI (Horizontal Situation Indicator)
Heading Bug Control Knob

HSI (Horizontal Situation Indicator)
Course Setting Bug Control Knob

C-101CC
Rear Seat



C-101CC
Rear Seat



Map Case
• Scroll mousewheel to open case

C-101CC
Rear Seat



C-101CC

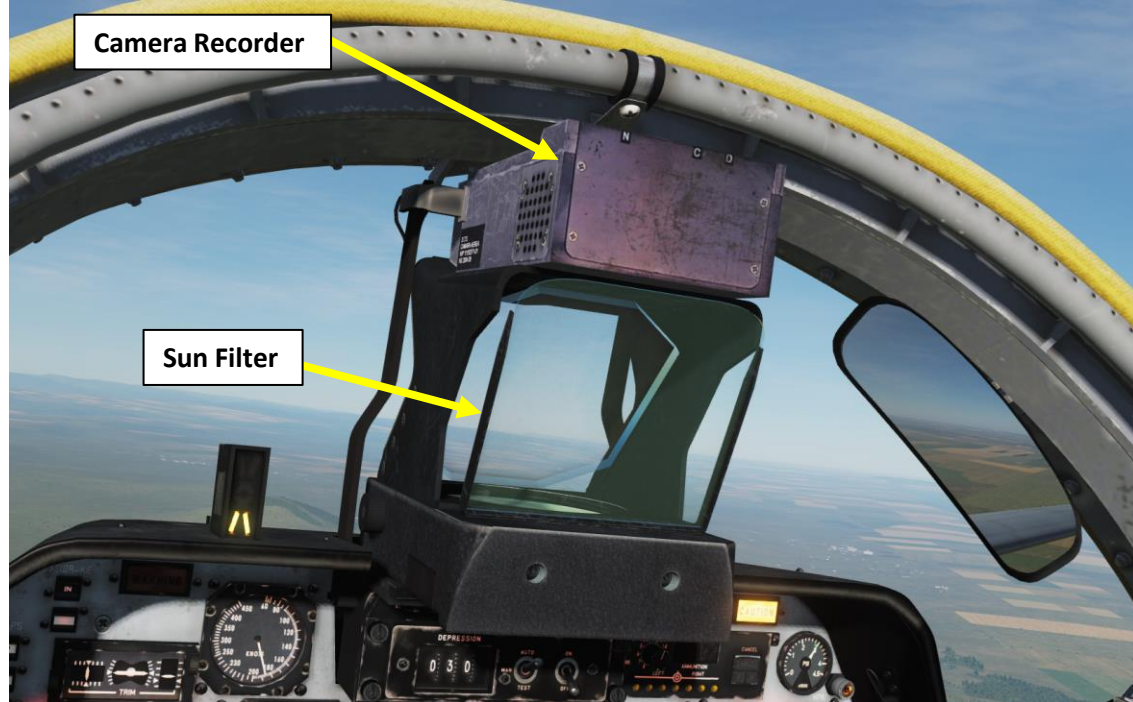
Click to stow/deploy hood

IFR (Instrument Flight Rules) Training Hood

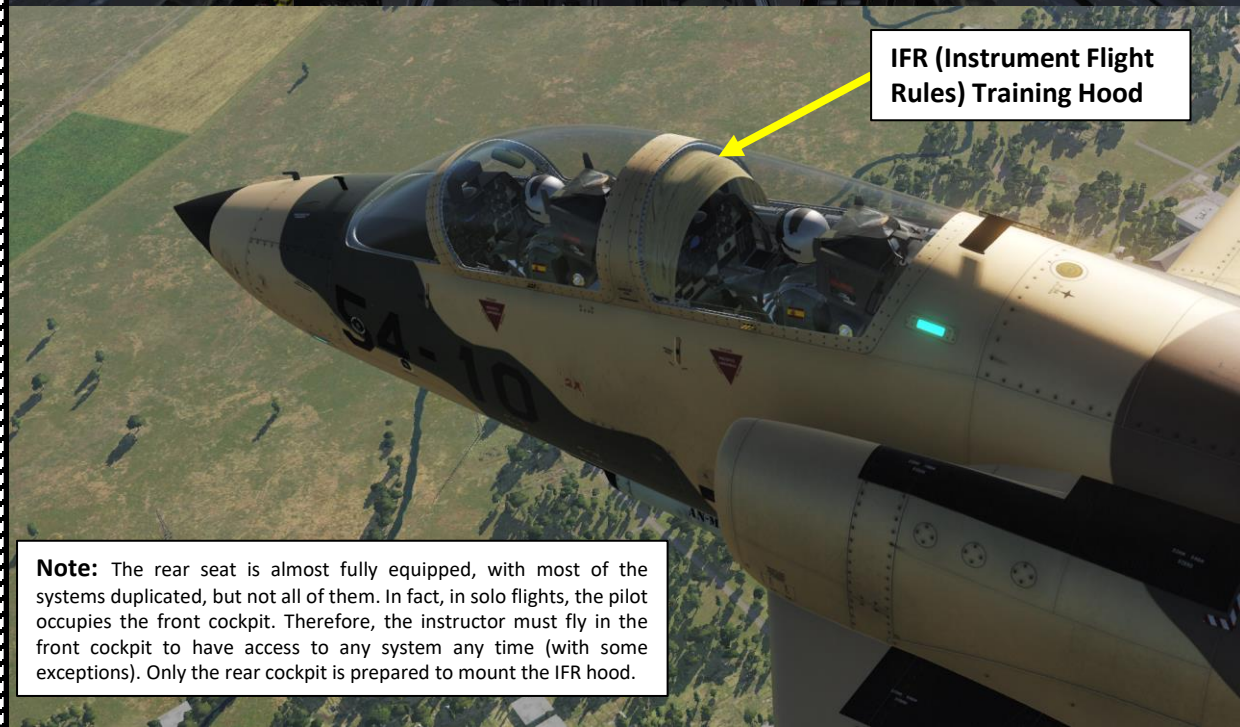


Camera Recorder

Sun Filter



IFR (Instrument Flight Rules) Training Hood



Note: The rear seat is almost fully equipped, with most of the systems duplicated, but not all of them. In fact, in solo flights, the pilot occupies the front cockpit. Therefore, the instructor must fly in the front cockpit to have access to any system any time (with some exceptions). Only the rear cockpit is prepared to mount the IFR hood.

AIRCRAFT GROUP

NAME: New Airplane Group

CONDITION: % < > 100

COUNTRY: Spain

TASK: CAS

UNIT: < > 1 OF < > 1

TYPE: C-101CC

SKILL: Player

PILOT: Pilot #001

TAIL #: 010 COMM 225 MHz AM

CALLSIGN: Enfield 1 1

HIDDEN ON MAP

LATE ACTIVATION

Additional properties for aircraft

- Solo Flight:
- Aircraft Control Priority: Instructor
- Mount IFR Hood:
- Camera Recorder:
- Sight Sun Filter:

Aircraft Equipment Settings (Mission Editor)

C-101CC

Position Light

Anti-Collision Light

Position Light

Position Light



C-101CC

Taxi/Landing Light

Taxi/Landing Light

Silhouette Lights

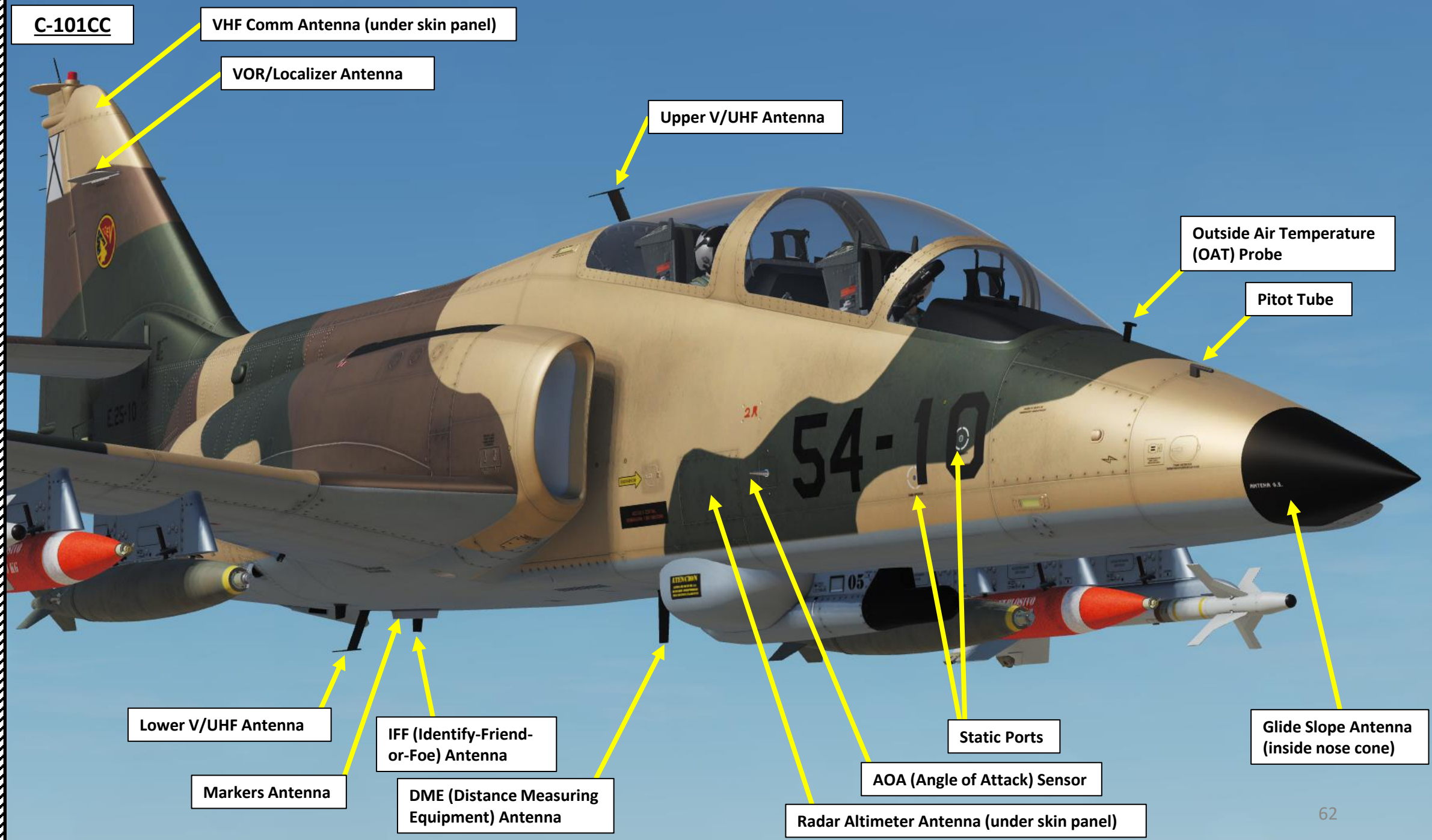
Formation Light

Formation Light

Formation Light

Formation Lights





C-101CC

VHF Comm Antenna (under skin panel)

VOR/Localizer Antenna

Upper V/UHF Antenna

Outside Air Temperature (OAT) Probe

Pitot Tube

Lower V/UHF Antenna

IFF (Identify-Friend-or-Foe) Antenna

Markers Antenna

DME (Distance Measuring Equipment) Antenna

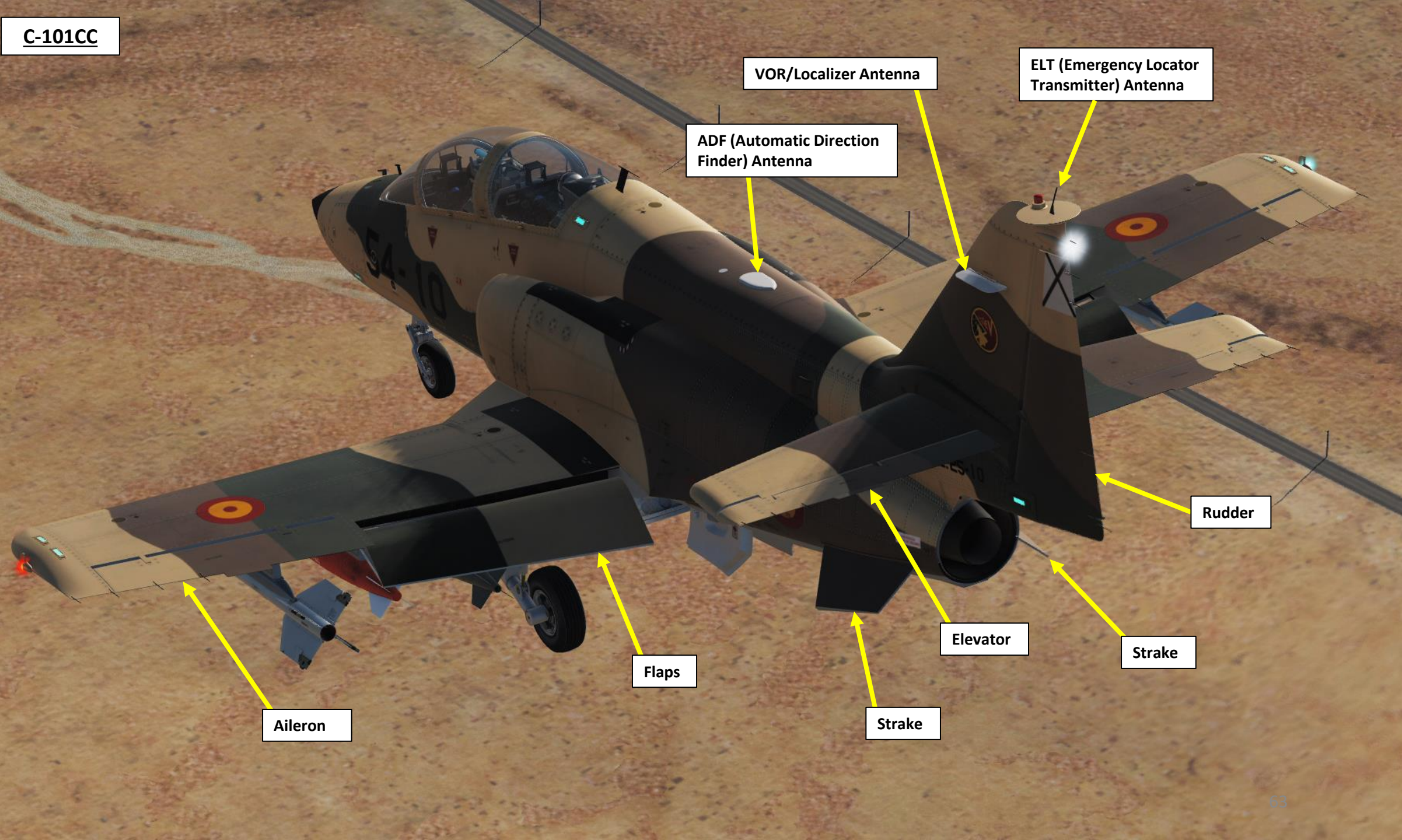
Static Ports

AOA (Angle of Attack) Sensor

Glide Slope Antenna (inside nose cone)

Radar Altimeter Antenna (under skin panel)

C-101CC



Aileron

Flaps

Strake

Elevator

Strake

Rudder

ADF (Automatic Direction Finder) Antenna

VOR/Localizer Antenna

ELT (Emergency Locator Transmitter) Antenna

C-101CC



Airbrake

C-101EB



Rear Seat
(Instructor Pilot)

Front Seat
(Student Pilot)

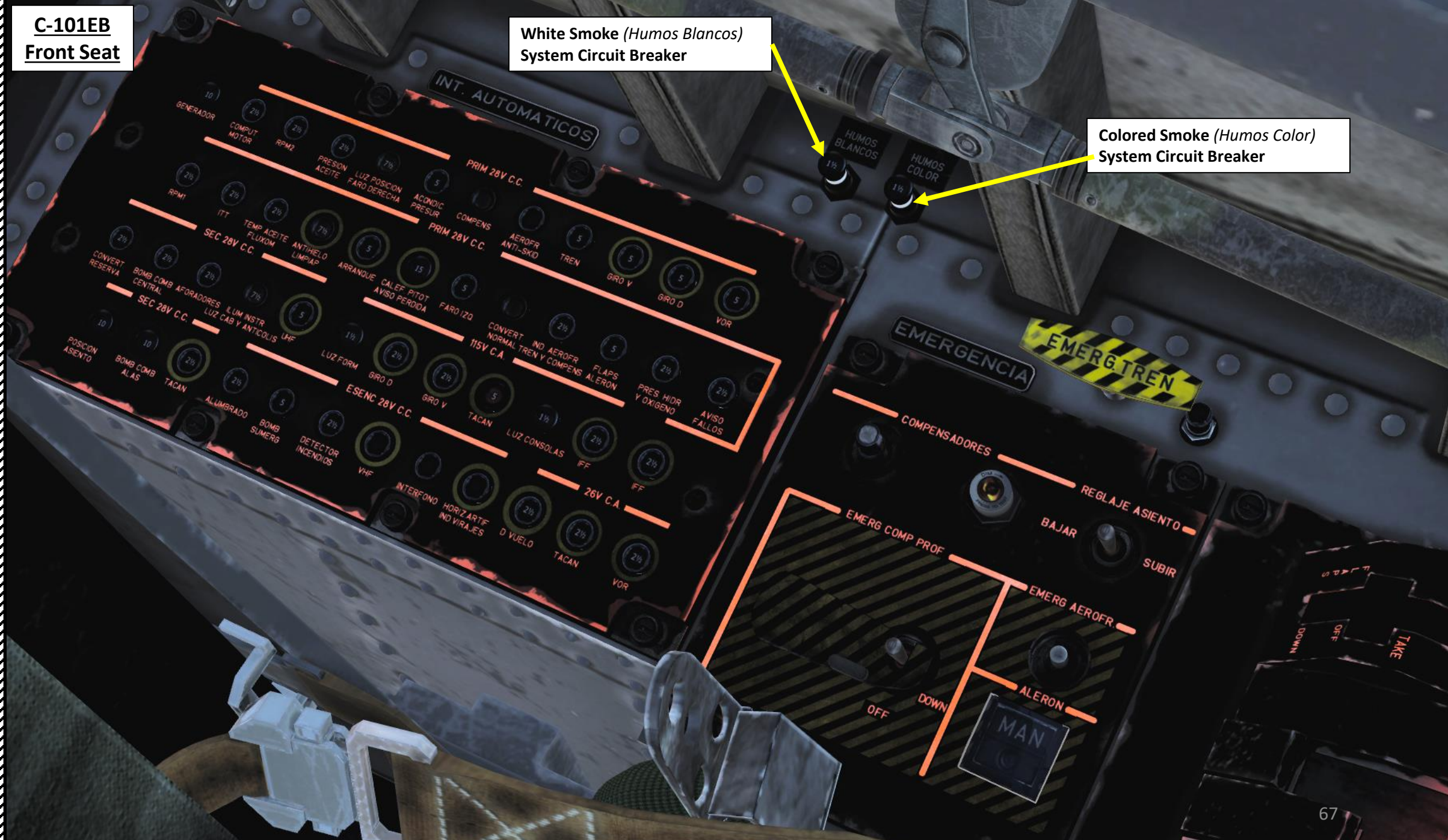
C-101EB



C-101EB
Front Seat

White Smoke (Humos Blancos)
System Circuit Breaker

Colored Smoke (Humos Color)
System Circuit Breaker





Engine Computer Control Switch

- OFF (Korry illuminated): Computer disconnected
- ON (Korry extinguished): Computer in automatic mode

C-101EB
Front Seat



C-101EB Front Seat



RMI (Radio-Magnetic Indicator)

Radio Magnetic Indicator (RMI)



Figure 3-81 RMI

- 1 ROTATING COMPASS DIAL
- 2 HEADING REFERENCE INDEX
- 3 TARSYN FAILURE WARNING FLAG
- 4 SINGLE POINTER (VOR)
- 5 DOUBLE POINTER (TACAN)

HSI (Horizontal Situation Indicator)



Figure 3-77 HSI

- 1 GYRO SYNCHRONIZATION ANNUNCIATOR
- 2 NAVIGATION FAILURE FLAG
- 3 COURSE DEVIATION INDICATOR (CDI) BAR
- 4 COURSE DISPLAY
- 5 HEADING FAILURE FLAG
- 6 HEADING REFERENCE INDEX
- 7 DISTANCE DISPLAY
- 8 GLIDE SLOPE DEVIATION POINTER
- 9 GLIDE SLOPE FAILURE FLAG
- 10 HEADING BUG
- 11 COURSE SELECT POINTER
- 12 TO-FROM ANNUNCIATOR
- 13 RECIPROCAL POINTER COURSE

C-101EB Front Seat

Smoke Colorant (Humo de Color) Valve Open Light

White Smoke (Humo Blanco) Valve Closed (Cerrado) Light

White Smoke (Humo Blanco) Valve Open (Abierto) Light

UHF Antenna Selector
 • UP: Upper (Superior)
 • MIDDLE: Auto
 • DOWN: Lower (Inferior)

TARSYN Directional Gyro Synchronization Switch

HSI (Horizontal Situation Indicator) Heading Bug Control Knob

TARSYN Vertical Gyro Fast Erect Switch (Erección Rápida)

TARSYN Gyro Operation Mode Selector
 • UP: Compass (Brújula)
 • DOWN: Directional Gyro (Giro Direccional)

HSI (Horizontal Situation Indicator) Course Setting Bug Control Knob

TARSYN 333 Control Panel
 The C101-EB uses the TARSYN 333, a sensor system comprising a vertical gyro, a horizontal gyro and the corresponding electronic elements mounted on a common base. It supplies pitch, roll and heading information to the navigation systems. The system provides automatic initial erection and synchronization, manual directional gyro synchronization and manual vertical gyro fast erection. The C-101CC uses a more modern AHRS (Attitude & Heading Reference System).

AN/ARC-164(V) UHF Radio Panel

VOR/TACAN Selector
 • Selects VOR or TACAN Navigation

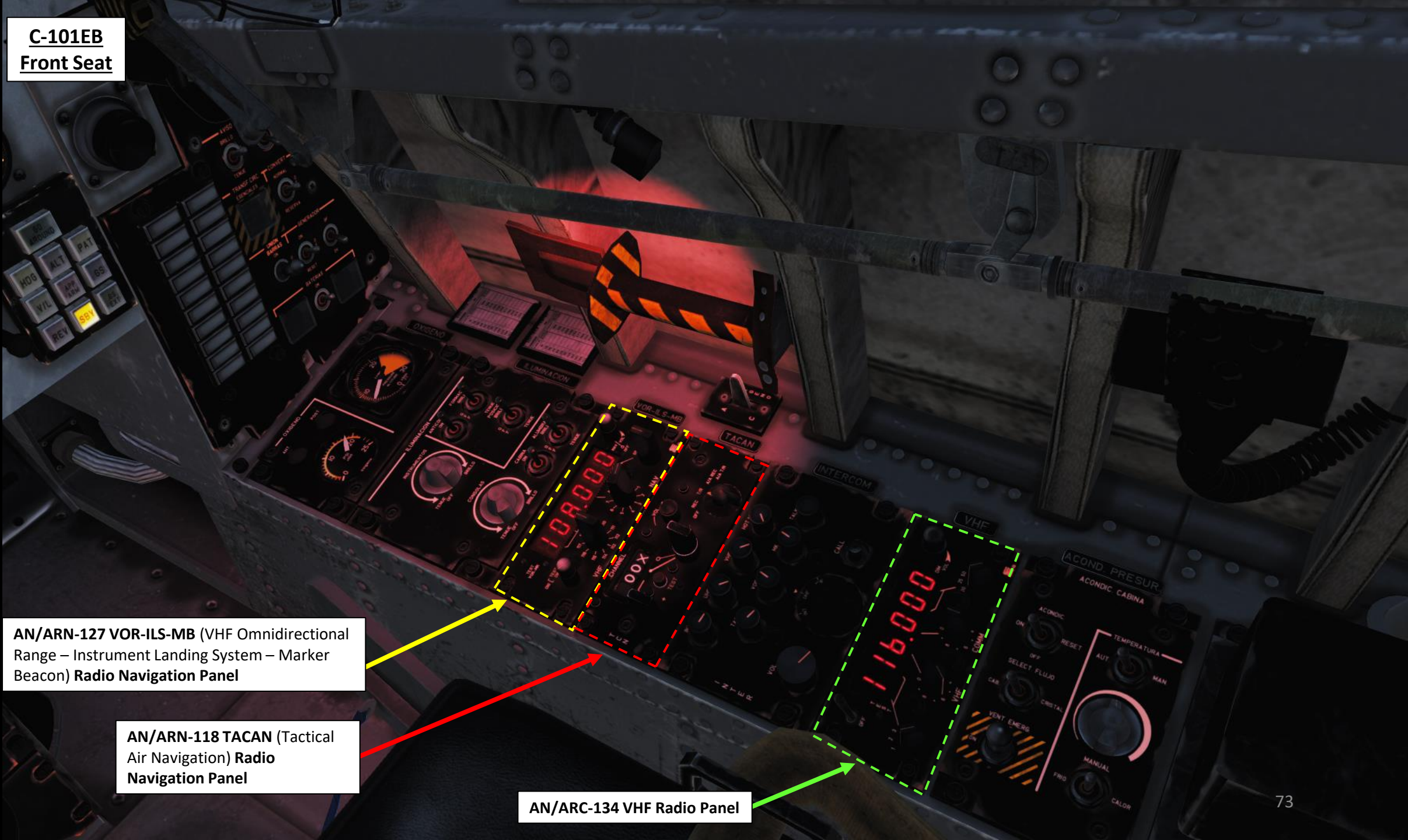


**C-101EB
Front Seat**

Scroll mousewheel on this placard to reveal a panel to save Preset frequency without having to use the Mission Editor. It is a panel to set preset channel frequencies usually on ground before the flight.

AN/ARC-164(V) UHF Radio Panel





AN/ARN-127 VOR-ILS-MB (VHF Omnidirectional Range – Instrument Landing System – Marker Beacon) Radio Navigation Panel

AN/ARN-118 TACAN (Tactical Air Navigation) Radio Navigation Panel

AN/ARC-134 VHF Radio Panel

PART 3 - COCKPIT & AIRCRAFT DESCRIPTION

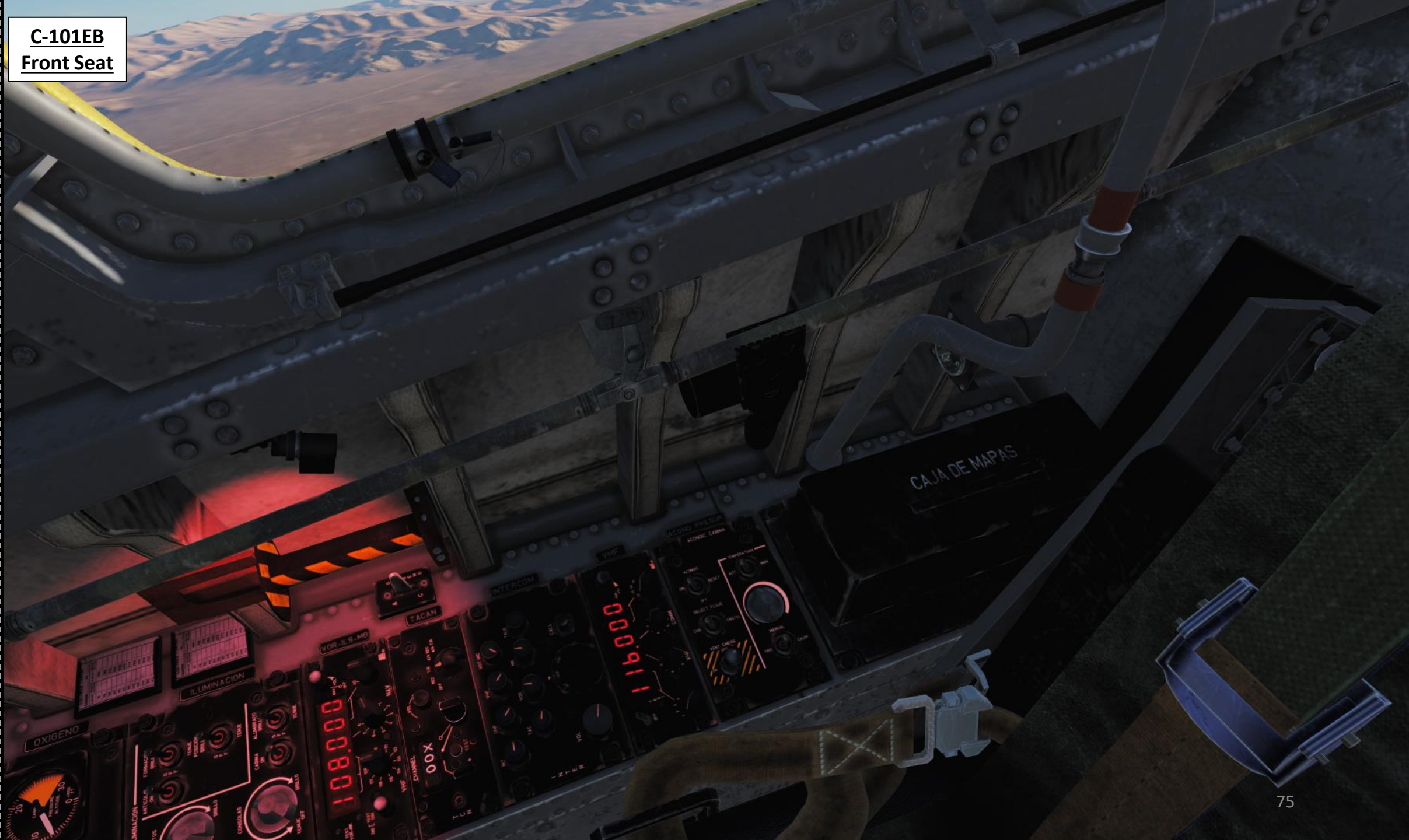
C-101CC
AVIOJET



C-101EB
Front Seat



C-101EB
Front Seat



C-101EB



Smoke Generator System
Diesel Injector



Figure 10-4 Control Stick Buttons

- 1 STORES RELEASE BUTTON (WHITE SMOKE)
- 2 FIXED WEAPONS TRIGGER (COLORANT)

C-101CC
AVIOJET



PART 4 - START-UP



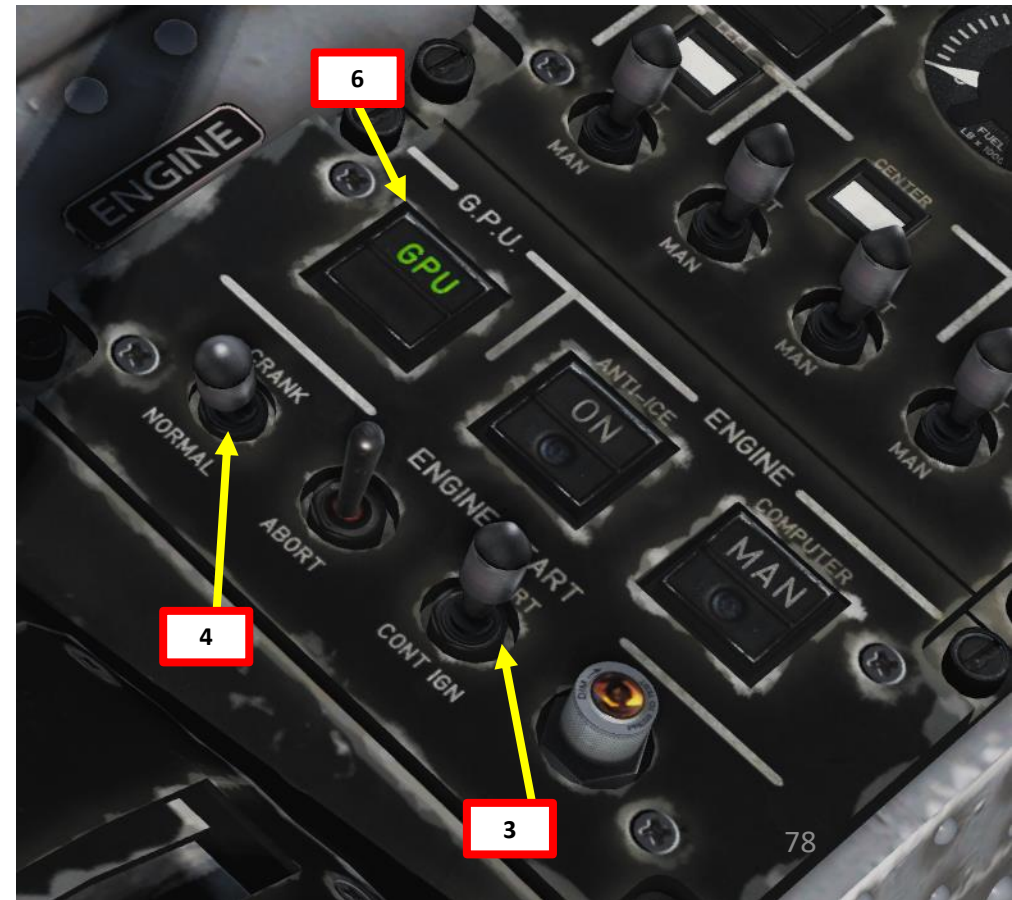
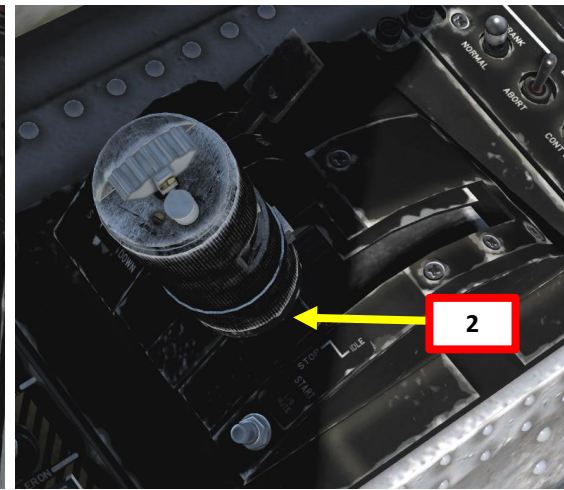
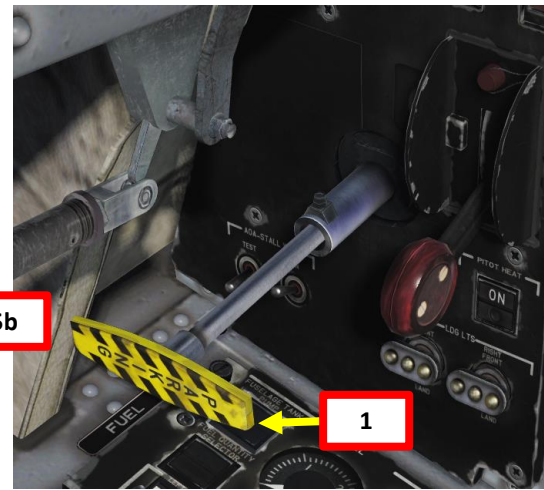
A - PRE-FLIGHT & INTERIOR INSPECTION

1. Engage Parking Brake (Lever Pulled/Out)
2. Verify that Throttle is set to STOP (Fully Aft)
3. Verify Ignition switch is set to OFF (Middle Position)
4. Verify that Starter switch is set to NORMAL (Aft Position)
5. Call ground crew for External Power (GPU, or Ground Power Unit)
 - a) Press “\” (Communication Menu) and “F8” to select ground crew
 - b) Select “Ground Electric Power” by pressing “F2”
 - c) Select “ON” by pressing “F1” to turn on ground power
6. Confirm that the “GPU” button illuminates (Green Light) and that the “ON” indication is extinguished, meaning that the aircraft has electrical power from the GPU available, but the airplane’s electrical network is not yet energized.
7. Press the Accelerometer Reset Button (should display 1 G).
8. AHRS (Attitude & Heading Reference System) Gyro Compass Mode Switch – Slaved to Magnetic Compass (*Brujula*)

Main
 F1. Wingman...
 F2. Flight...
 F3. Second Element...
 F5. ATC...
 F8. Ground Crew... ← **5a**
 F12. Exit

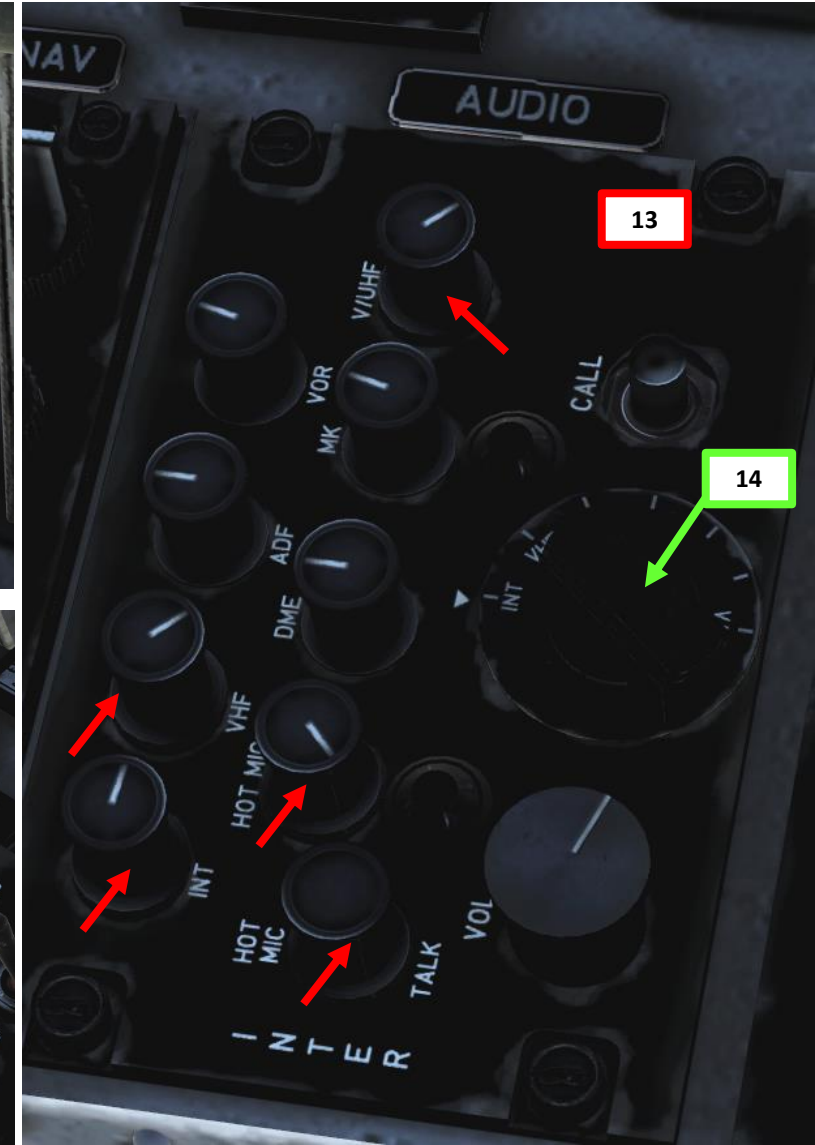
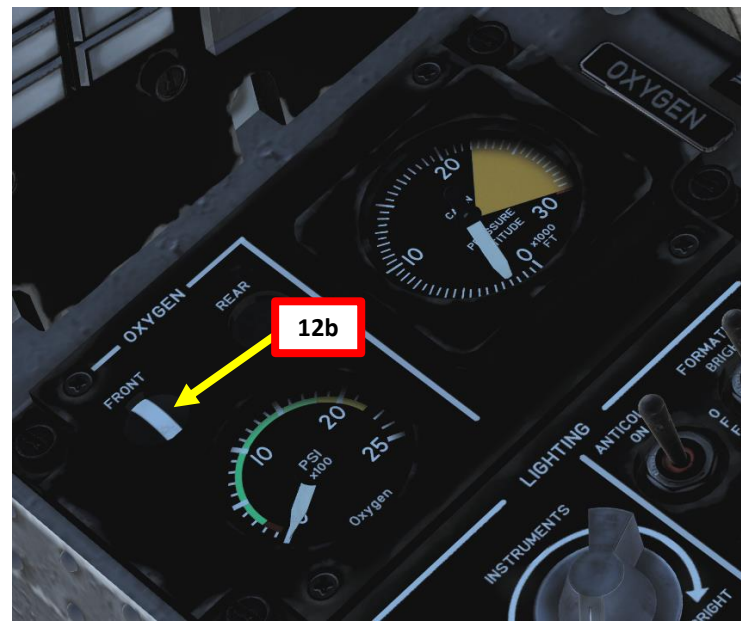
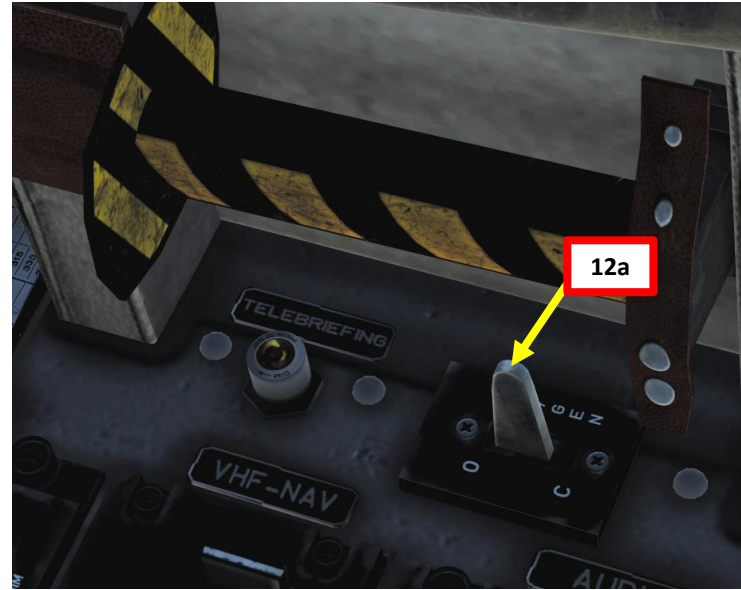
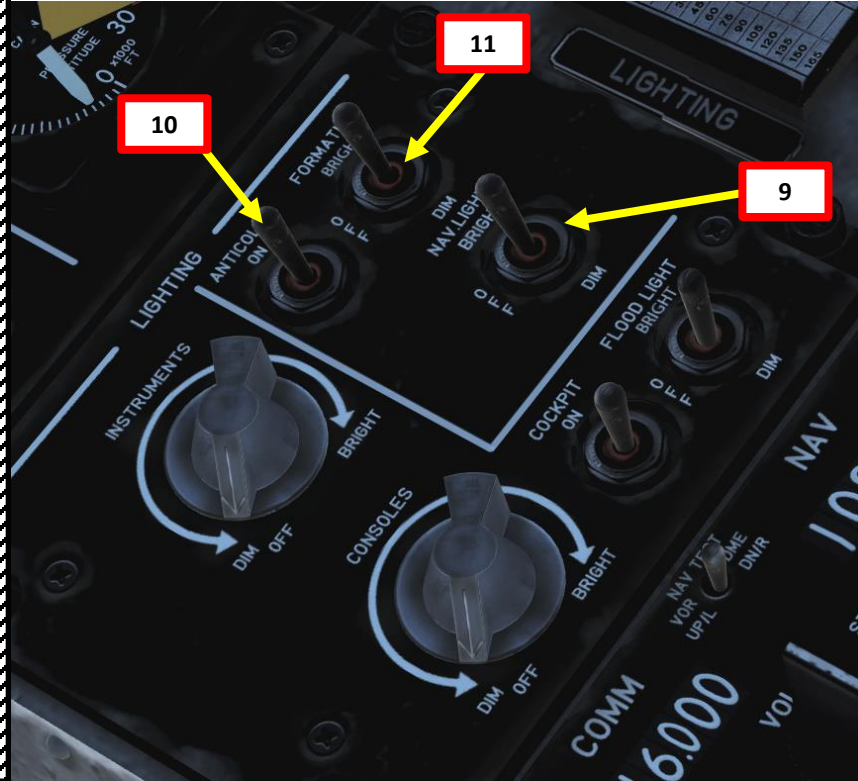
2. Main. Ground Crew
 F1. Rearm & Refuel
 F2. Ground Electric Power... ← **5b**
 F3. Request Repair
 F11. Previous Menu
 F12. Exit

3. Main. Ground Crew. Ground Electric Power
 F1. On ← **5c**
 F2. Off
 F11. Previous Menu
 F12. Exit



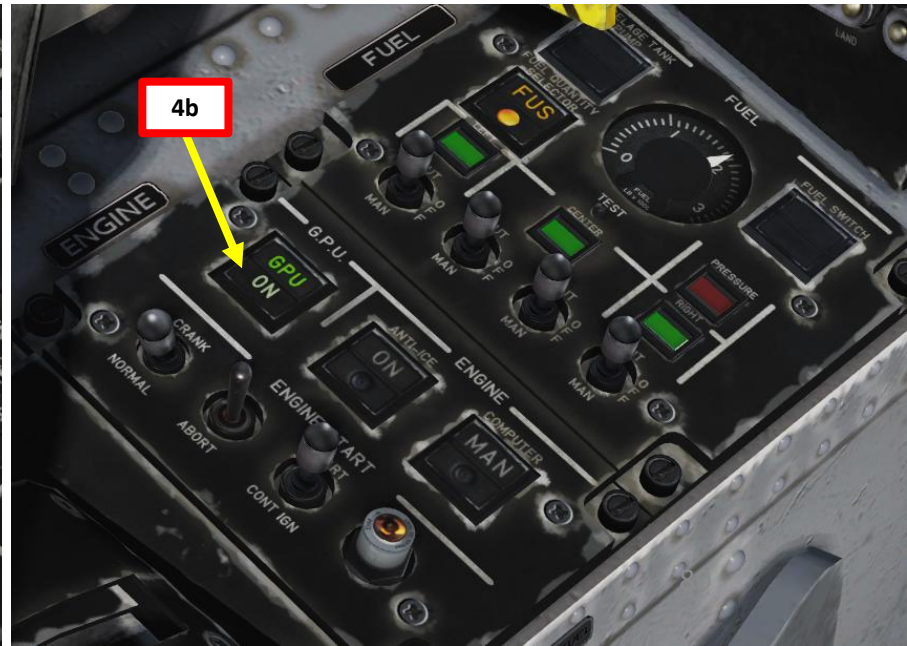
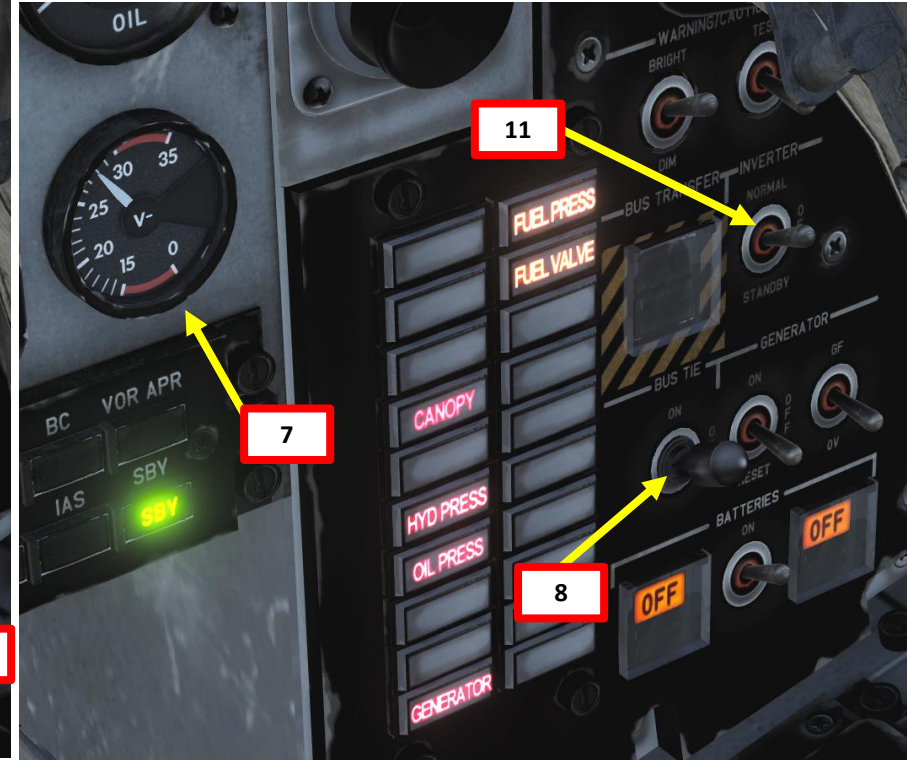
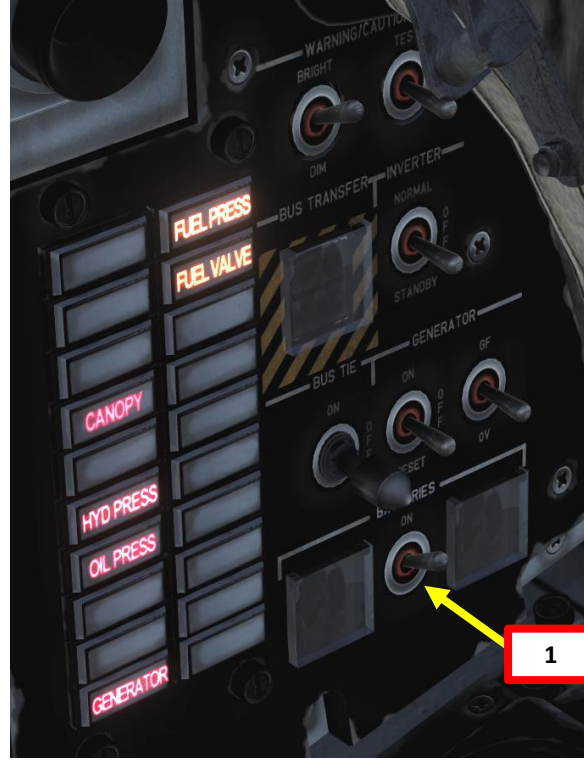
A - PRE-FLIGHT & INTERIOR INSPECTION

9. Set Position (Navigation) Lights Switch – Bright (*Brillo*)
10. Set Anti-Collision Lights Switch – ON (Fwd)
11. Set Formation Lights Switch – Bright (*Brillo*)
12. Oxygen Valve Switch – Open (*Abierto*) (Fwd). Confirm that Oxygen Flow indicator for the front seat shows oxygen is available (white).
13. On Intercom Panel, set INT (Intercom), V/UHF, VHF, HOT MIC and TALK Audio Select button to ON (Left Click to Raise Knobs) and tune their volume by rotating the knobs.
14. On Intercom Panel, set Intercom Selector switch (Biscuit) to INT (Intercom).



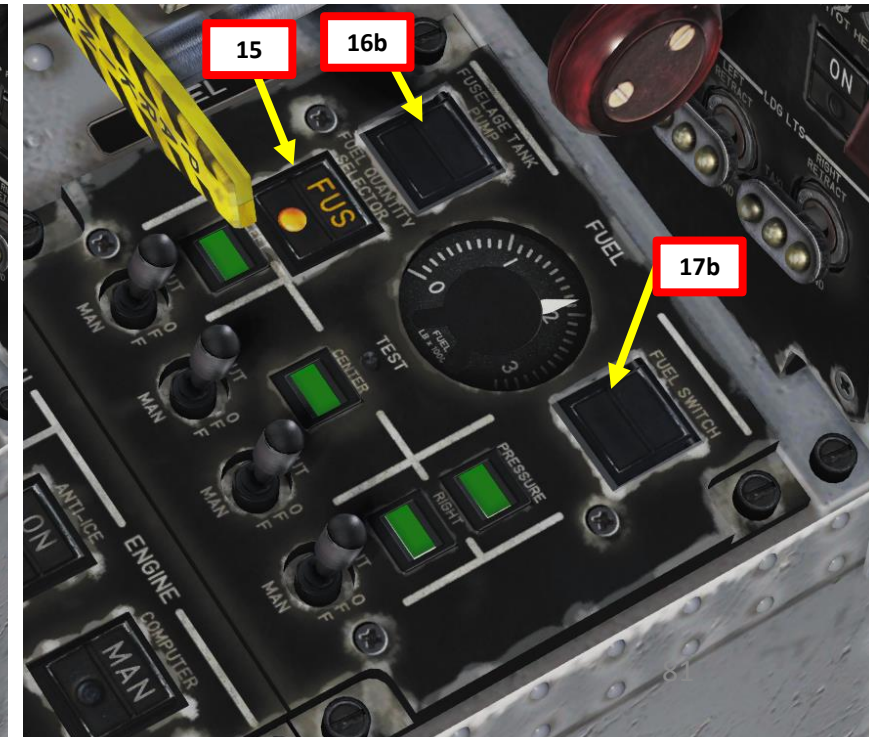
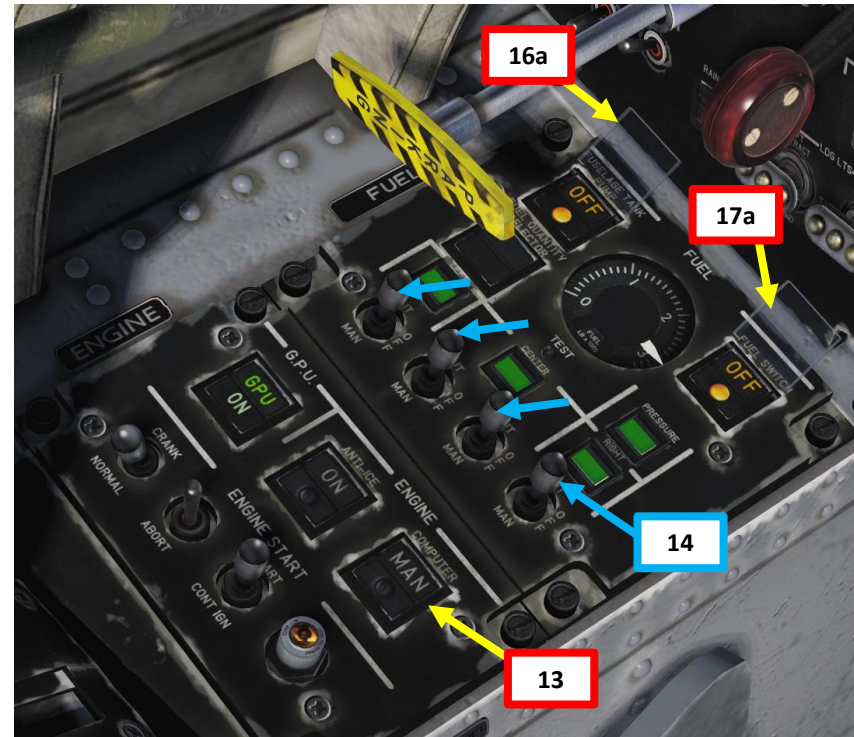
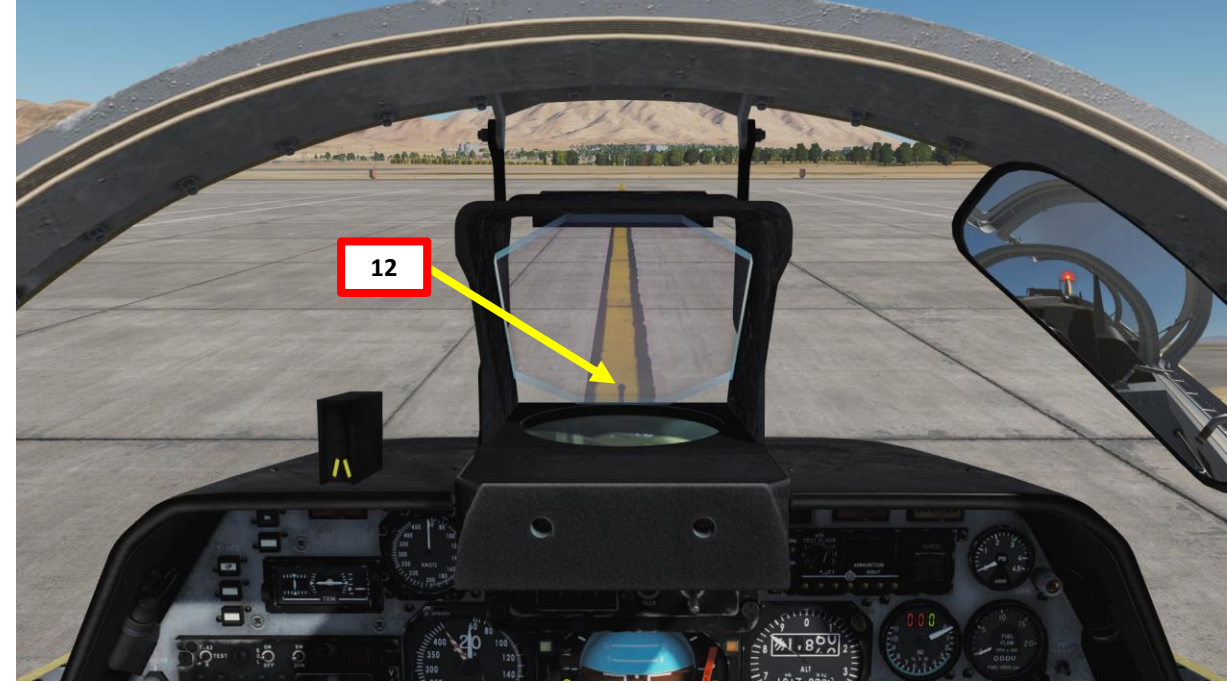
B - BEFORE START PROCEDURE

1. Set Battery Switch ON (UP)
2. Reset Master Warning (FALLO) Red Pushlight
3. Reset Master Caution (AVISO) Amber Pushlight
4. Press the GPU switch and confirm that the “ON” indication illuminates, meaning that the aircraft’s electrical network is energized by the GPU.
5. The ground crew will automatically remove wheel chocks once the aircraft is energized by the GPU.
6. Verify that the batteries and generators are automatically disconnected when ground power is on.
7. Confirm that Voltmeter displays at least 28 volts.
8. Set DC Bus Tie (Union de Barras) Switch ON (UP)
9. Reset Master Warning (FALLO) Red Pushlight
10. Reset Master Caution (AVISO) Amber Pushlight
11. Set AC Inverter (Convertidor) Switch – NORMAL (UP)



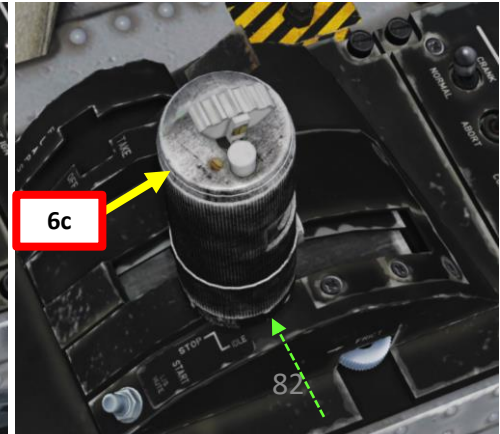
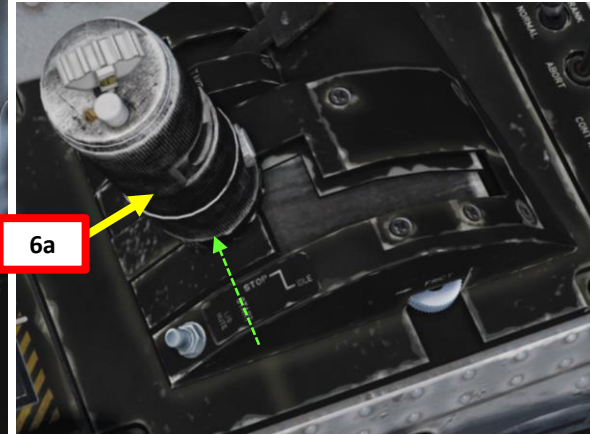
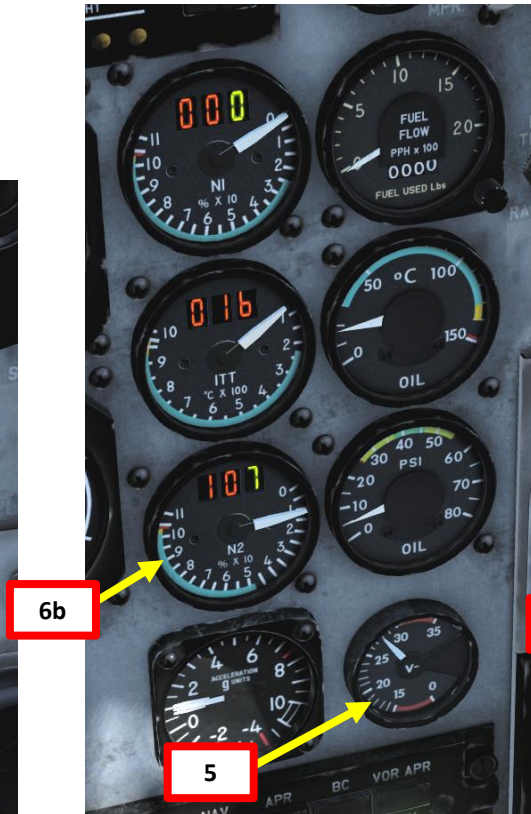
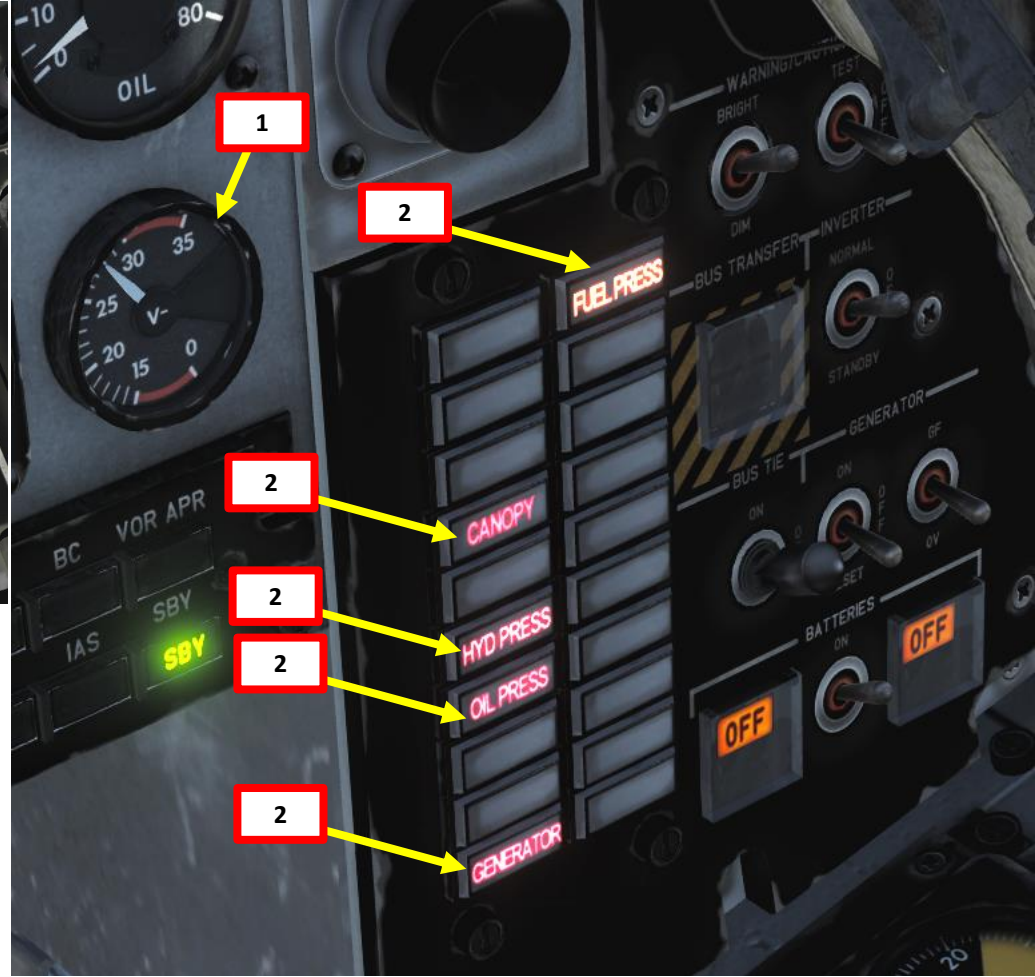
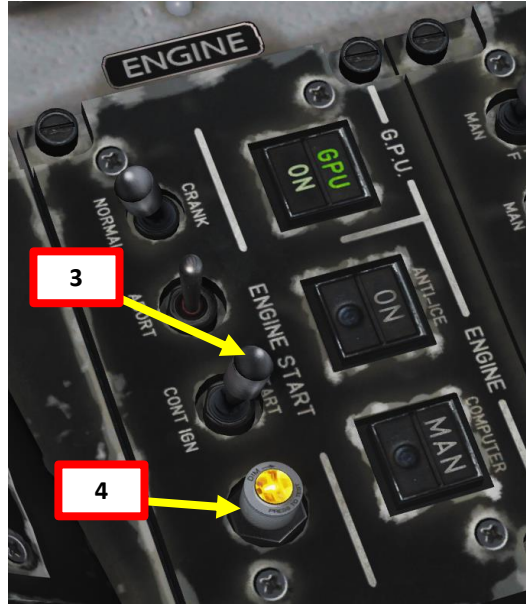
B - BEFORE START PROCEDURE

12. Adjust Seat Position (AFT = *Reglaje Asiento: Bajar / Lower seat.* FWD = *Subir / Raise seat*) so that the Pitot Tube is visible just above the nose of the aircraft.
13. Confirm that Engine Computer (*Computador – Control de Motor*) Switch is set to AUTO (Korry MAN/OFF indication is Extinguished)
14. Set Fuel Transfer Pump Switches to AUTO (FWD), but leave Fuel Transfer Pump switches for empty fuel tanks (red fuel indication) to OFF (Middle).
15. Set Fuel Quantity Selector to FUS (Fuselage). Korry should illuminate.
16. Set Submerged Fuselage Fuel Tank Boost Pump (*Bomba Sumeraida*) to ON (Korry and OFF indication should extinguish when pump is energized).
17. Set Fuel Shutoff Valve (*Llave de Combustible*) Switch to OPEN (Korry and OFF indication should extinguish when fuel shutoff valve is energized).



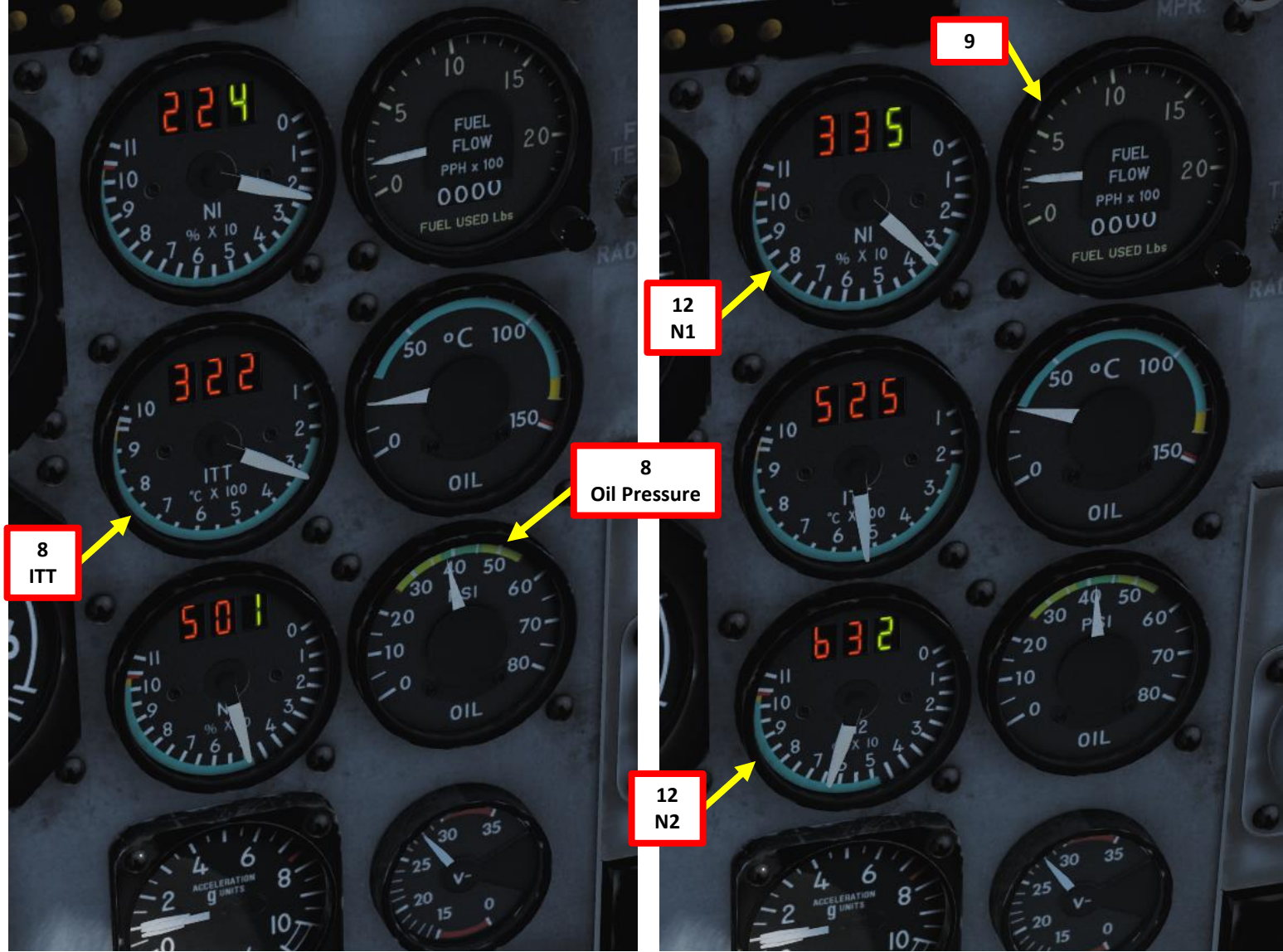
C - START-UP PROCEDURE

1. Confirm that Voltmeter displays between 28 and 30 V.
2. Confirm that CAWS Panel has the five following cautions illuminated:
 - **CANOPY / BLOC CAB** (Canopy Unlocked)
 - **HYD PRESS / PRES HDR** (Low Hydraulic Pressure)
 - **OIL PRESS / PRES ACTE** (Low Oil Pressure)
 - **GENERATOR / X.GEN CC** (Generator Failure)
 - **FUEL PRESS / PRES COMB** (Low Fuel Pressure)
3. Hold Ignition Switch to START (Fwd) for 2 seconds, then release. Switch will be spring-loaded back to Middle position.
4. Confirm that Ignition Lamp illuminates
5. Confirm that Voltage is above 15 V
6. When N2 (High Pressure Compressor Speed) reaches approx. 10 % RPM, click on the throttle to set it from STOP to IDLE.
7. Before N2 indication exceeds 20 % RPM, confirm that N1 (Low Pressure Compressor Speed) starts increasing as well.



C - START-UP PROCEDURE

8. Confirm that Oil Pressure and ITT (Inter-Turbine Temperature) start increasing within 10 seconds and do not exceed their redlines. In case of a parameter exceedance, abort start by pressing the ABORT switch.
9. Confirm that Fuel flow stabilizes at 200 lbs/hour (pph)
10. Confirm that Hydraulic Pressure rises to 3000 psi
11. Confirm that Ignition Lamp extinguishes at 50 % N2.
12. Engine parameters should stabilize (N1 between 29 and 33 % RPM / N2 between 58 and 71 % RPM)
13. Check that Engine Computer is operating in AUTO mode (Korry Extinguished)



GROUND START CYCLES

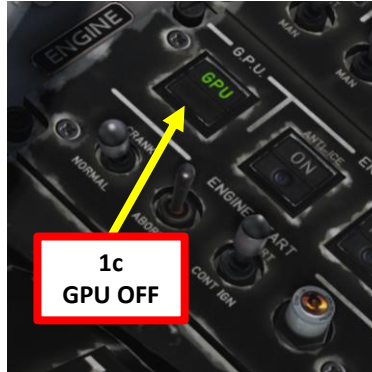
First start attempt: 30 sec ON, 1 min OFF

Second start attempt: 30 sec ON, 1 min OFF

Third start attempt: 30 sec ON, 30 min OFF

D - AFTER START PROCEDURE

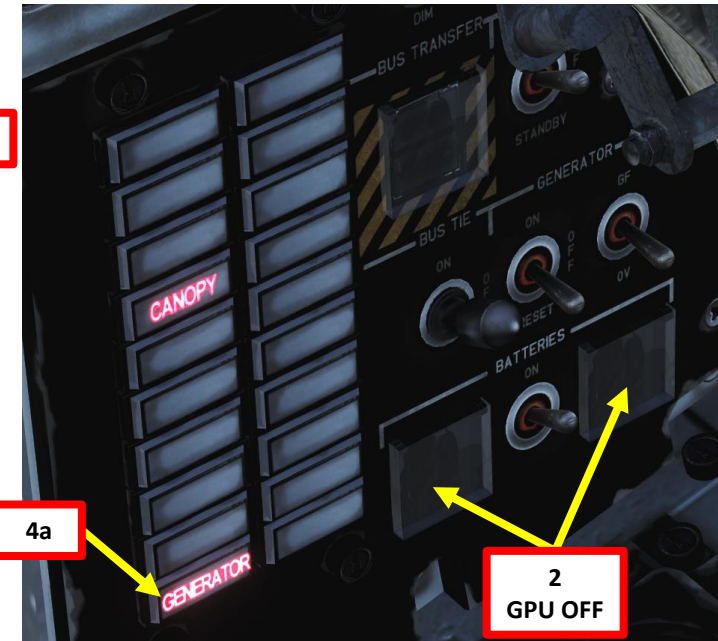
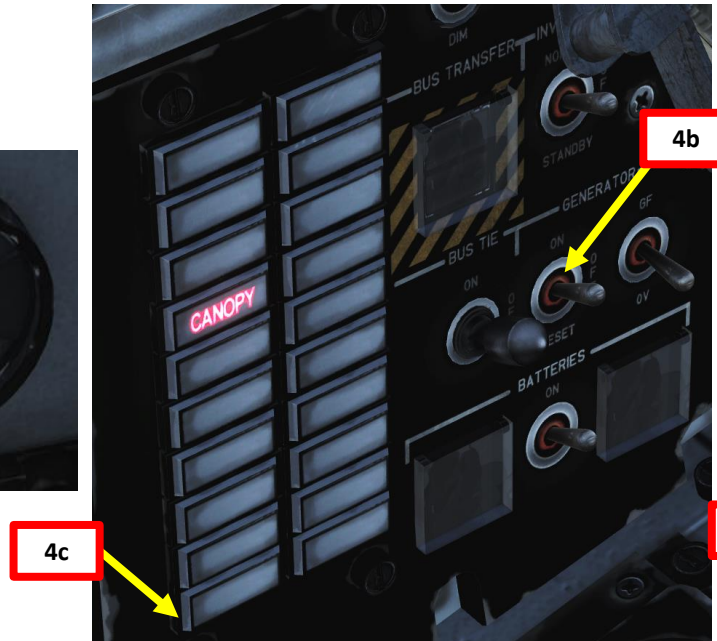
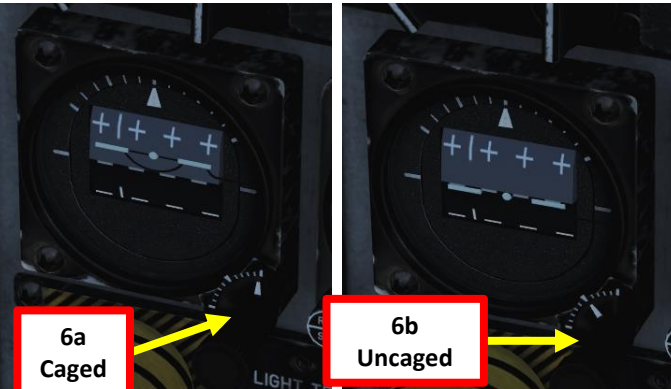
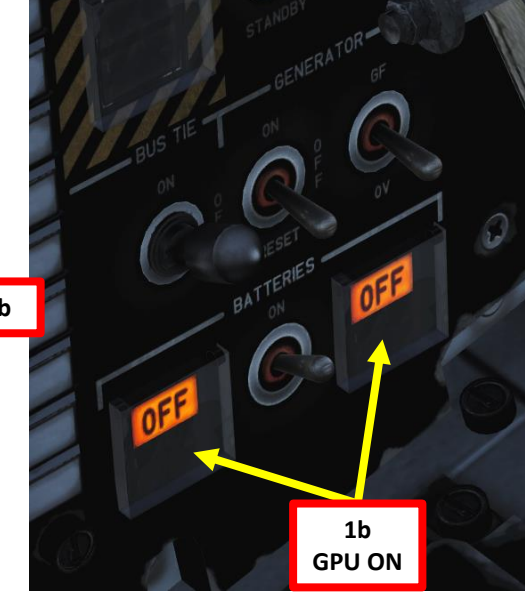
1. Press the GPU switch and confirm that the "ON" indication extinguishes, meaning that the aircraft's electrical network is not energized by the GPU anymore.
2. Verify that the batteries are automatically connected when ground power is OFF.
3. Call ground crew to remove External Power (GPU, or Ground Power Unit)
 - a) Press "\" (Communication Menu) and "F8" to select ground crew
 - b) Select "Ground Electric Power" by pressing "F2"
 - c) Select "OFF" by pressing "F2" to turn off ground power
4. Set Generator Switch to RESET (Down), then set to ON (UP). Confirm on the CAWS Panel that **GENERATOR / X. GEN CC** (Generator Failure) caution is extinguished and the generators have kicked in.
5. Confirm that Voltmeter displays at least 28 volts.
6. Uncage Standby Artificial Horizon by rotating the caging knob.
7. Set IFF (Identify-Friend-or-Foe) System Selector to STBY (Standby).



Main
 F1. Wingman...
 F2. Flight...
 F3. Second Element...
 F5. ATC...
 F8. Ground Crew... ← **3a**
 F12. Exit

2. Main. Ground Crew
 F1. Rearm & Refuel
 F2. Ground Electric Power... ← **3b**
 F3. Request Repair
 F11. Previous Menu
 F12. Exit

3. Main. Ground Crew. Ground Electric Power
 F1. On
 F2. Off ← **3c**
 F11. Previous Menu
 F12. Exit

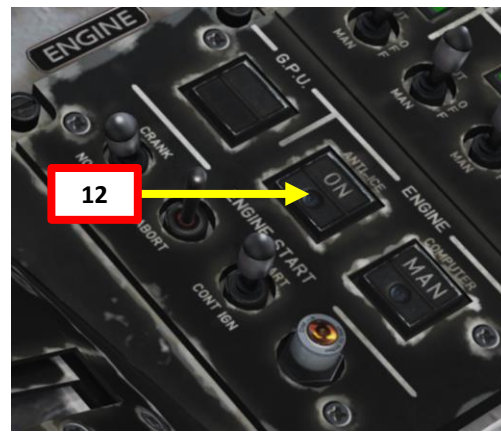
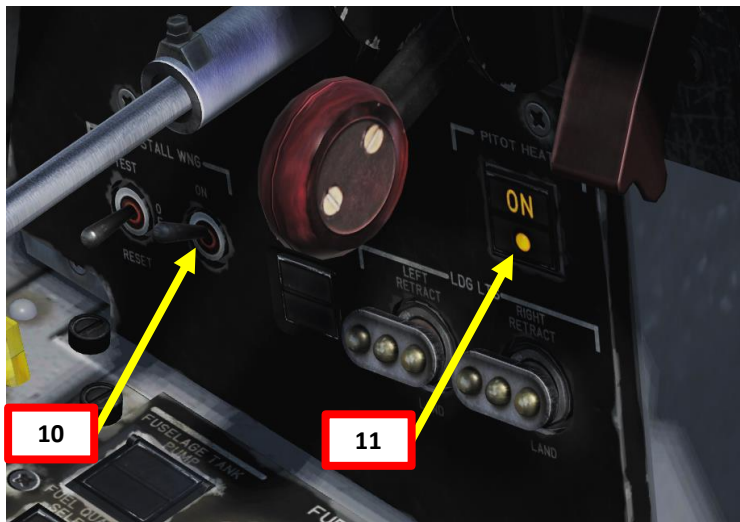


D - AFTER START PROCEDURE

8. Set Radio Altimeter Switch ON (UP)
9. Adjust Barometric Pressure of Altitude Indicator and Standby Altitude Indicator in order to set altimeter indication to the airport elevation (you can use "F10" to display the airport information). As an example, I have set the Barometric Pressure setting to 29.92 in of Hg in order to get an altimeter reading of about 1840 ft.
10. Set AoA (Angle of Attack) Stall Warning Power Switch ON (UP)
11. Set Pitot Heat switch to ON (Korry Illuminated)
12. Set Engine Anti-Ice (*Antihielo*) switch – As Required. Since no icing conditions are detected and the outside air temperature (OAT) is above 10 deg C, we can assume that we'll leave the Engine Anti-Ice OFF (Korry Extinguished) in order to maximize available engine power for takeoff.

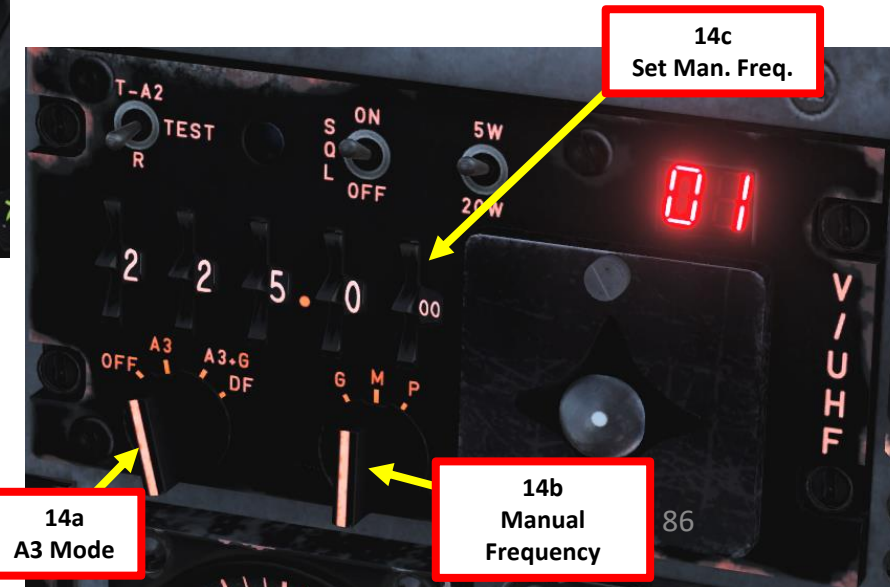
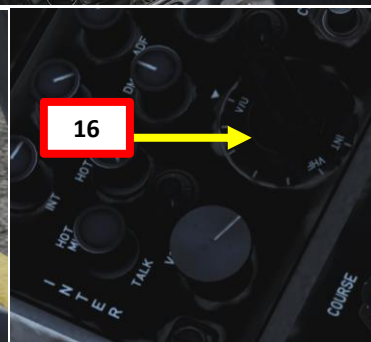
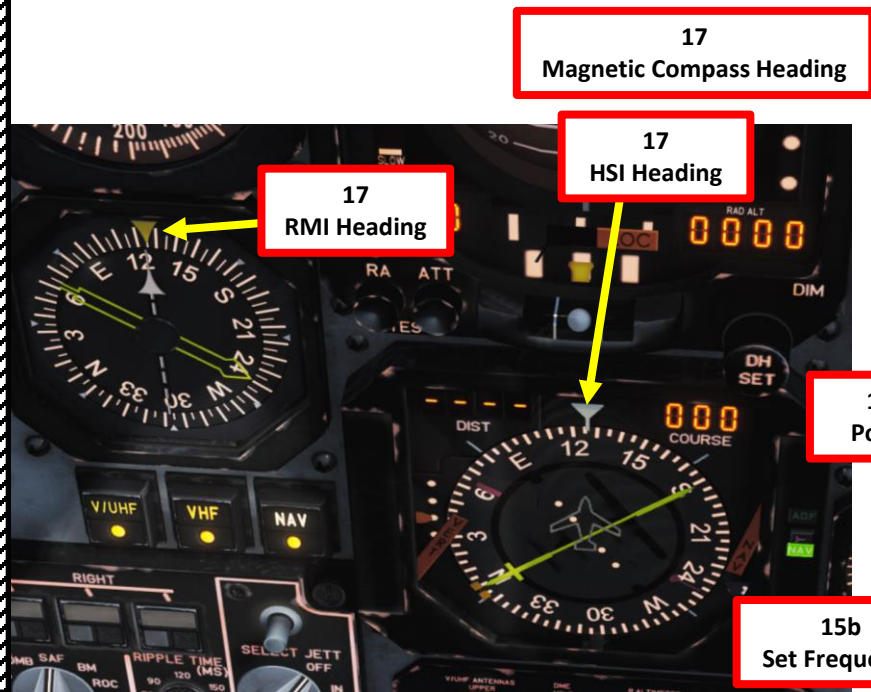
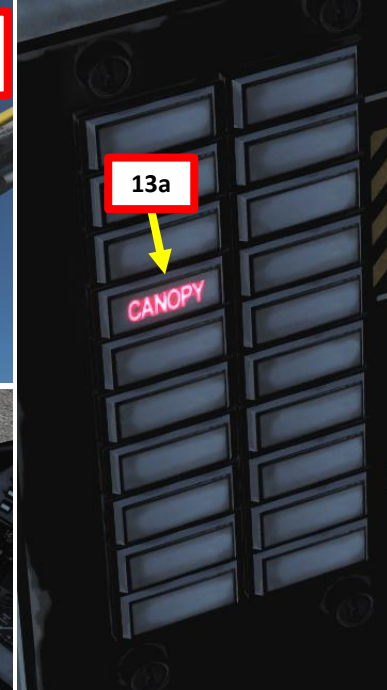


AIRDROME DATA	
NAME	Nellis AFB
ICAO	KLSV
COALITION	Blue
ELEVATION	1841 ft
RWY Length	9437 ft
COORDINATES	36°13'32"N 115°02'37"W
TACAN	12X (LSV)
VOR	--
R5BN	--
ATC	327.000, 132.550, 3.900, 38.700
RWys	3 21
ILS	-- 109.10 (IDIQ)
PRMG	-- --
OUTER NDB	-- --
INNER NDB	-- --
RESOURCES	



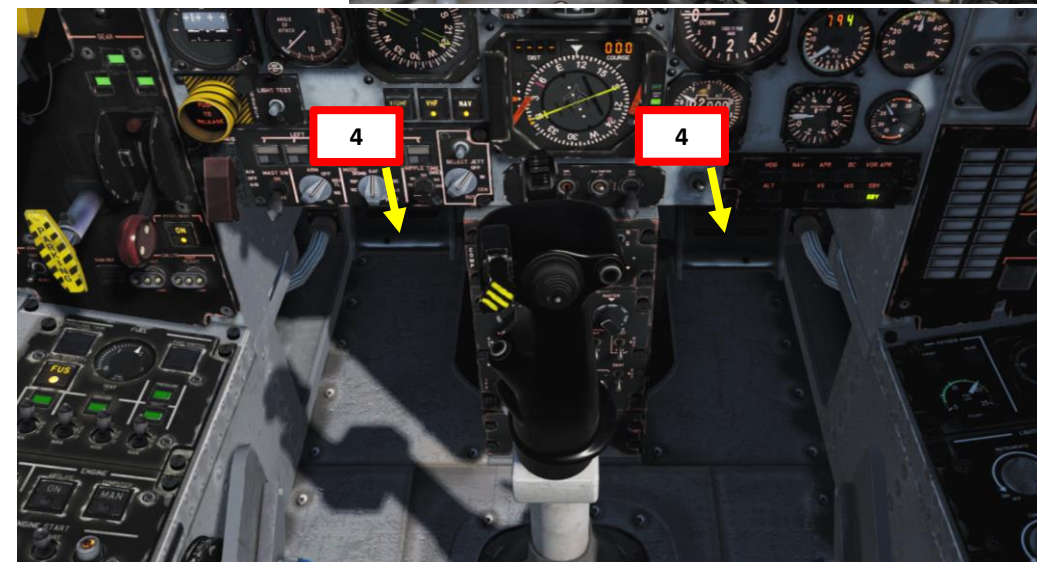
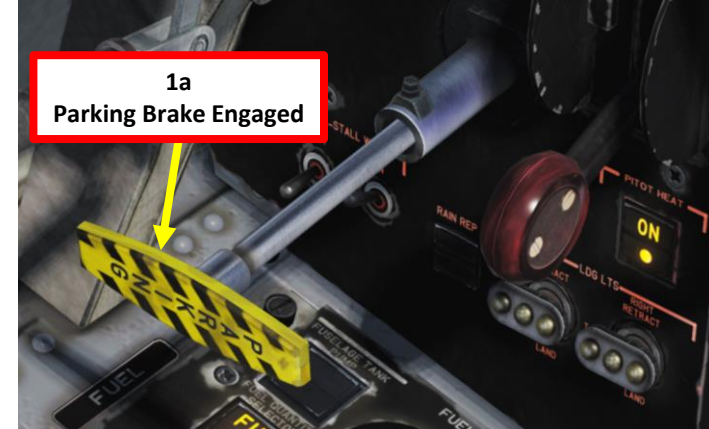
D - AFTER START PROCEDURE

13. Close and lock canopy by clicking the Canopy Handle, and then pushing the Canopy Lock lever forward. Confirm on the CAWS Panel that **CANOPY / BLOC CAB** (Canopy Unlocked) caution is extinguished. Make sure the rear cockpit's canopy is closed as well.
14. Set up V/UHF Radio as required.
15. Set up VHF Radio as required.
16. On Intercom Panel, set Intercom Selector switch (Biscuit) to either V/UHF or VHF.
17. Wait for AHRS gyroscoptic system (Attitude & Heading Reference System) alignment to complete (AHRS for the C-101CC, TARSYN for the C-101EB). Confirm that Magnetic Compass, HSI (Horizontal Situation Indicator) and RMI (Radio-Magnetic Indicator) headings are all the same; this means that all navigation systems are synchronized and aligned.



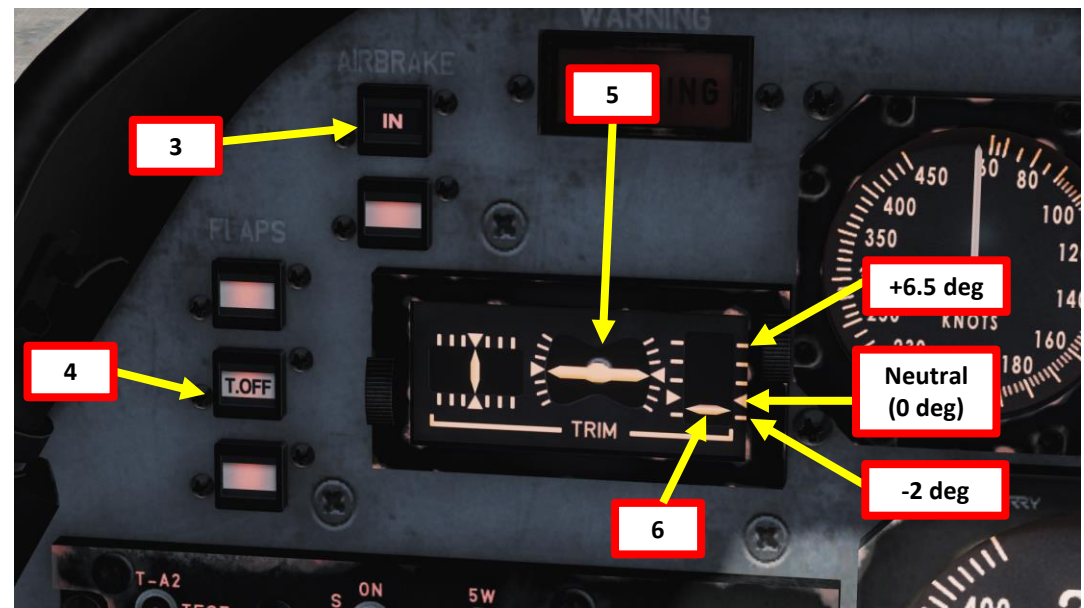
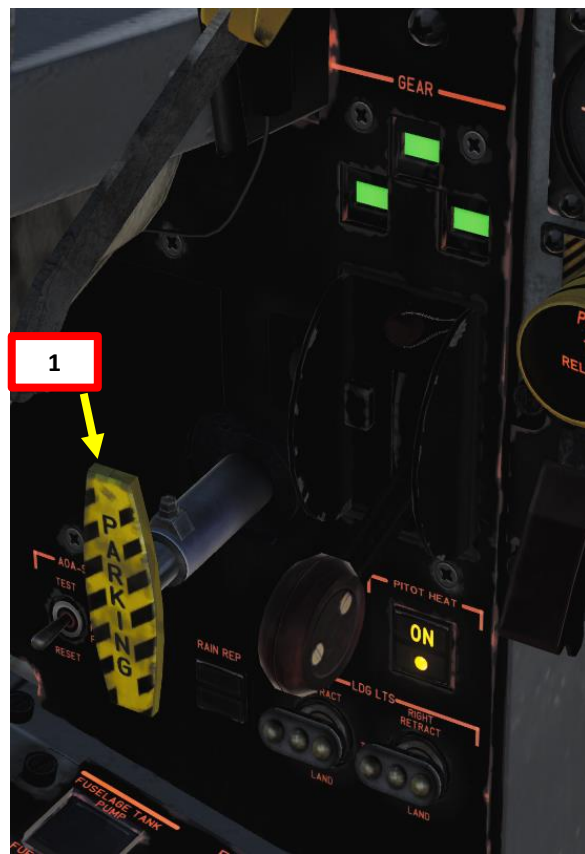
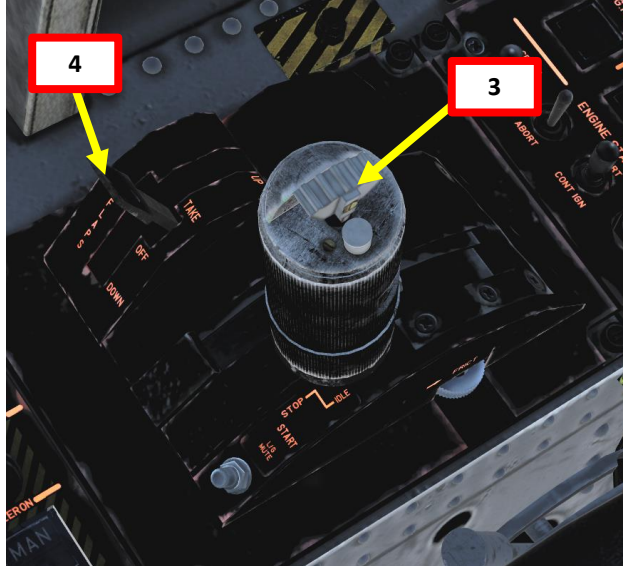
TAXI PROCEDURE

1. Release Parking Brake (Lever Pushed/In).
2. Set Anti-Skid switch – ON (OFF Light Extinguished)
3. Typically, in a controlled airfield you would request permission to taxi on the ground frequency.
4. Hold both toe brakes, set throttle to 50 % N1 RPM and check brake effectiveness.
5. Release toe brakes and start taxiing.
6. To execute a turn, press the toe brake on your rudder pedals and set throttle at IDLE during the turn. As an example, if you want to turn left, press the left toe brake. The differential braking will then rotate the castering nosewheel accordingly.



TAKEOFF PROCEDURE

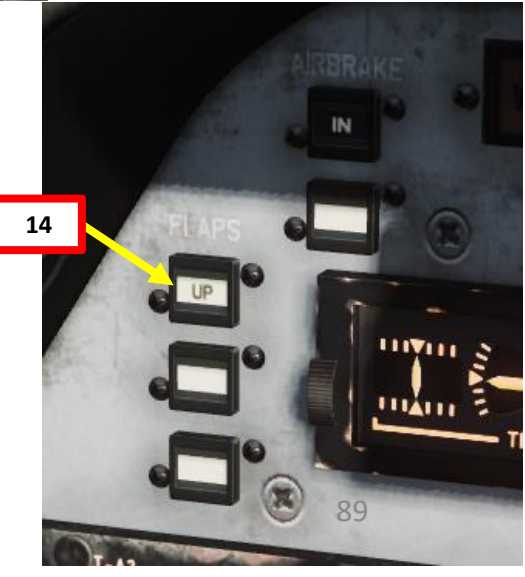
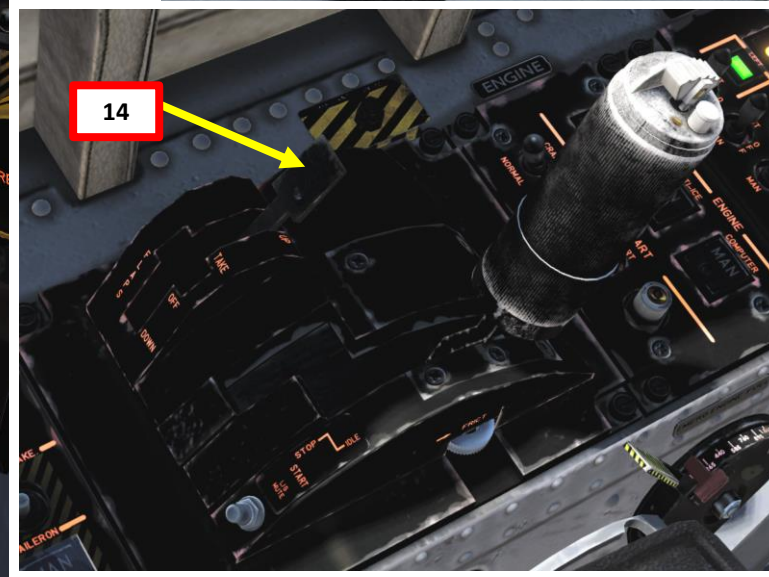
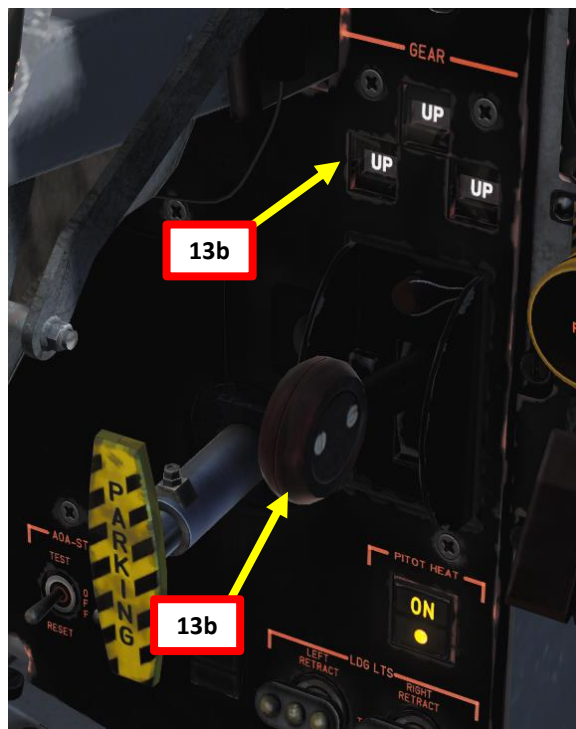
1. Verify that Parking Brake is released (Lever Pushed/In)
2. Advance enough to ensure the casting nosewheel is straight
3. Confirm that Airbrakes are IN
4. Set Flaps lever to TAKEOFF and confirm that the Flaps Indicator shows TAKEOFF.
5. Check that Aileron Trim is set to 0 deg. Aileron trim axis goes from -3 deg to +3 deg.
6. Set Elevator Trim to -1.5 deg. Elevator trim axis goes from -2 deg to +6.5 deg.
7. Set Engine Ignition Switch AFT to CONTINUOUS IGNITION (*IGNIC CONT*)



TAKEOFF PROCEDURE

8. Hold brakes and throttle up to max takeoff power (below all engine parameter redlines).
9. Wait for the engine to spool up, then release brakes once takeoff power is set.
10. Below 40 kts, use your toe brakes to correct your heading. Above 40 kts, rudder becomes effective and should be used to correct heading.
11. Start aircraft rotation at 100-105 kts (value for takeoff weight of 4800 kg, use higher speed for greater weights).
12. Nosewheel liftoff should start around 110-115 kts (value for takeoff weight of 4800 kg, use higher speed for greater weights)
13. Once a positive climb rate has been established, retract landing gear at or below 120 kts.
14. Retract flaps below 125 kts.
15. Establish climb speed.
16. Set Engine Ignition Switch to the MIDDLE position to (OFF) when reaching 6000 ft.

8



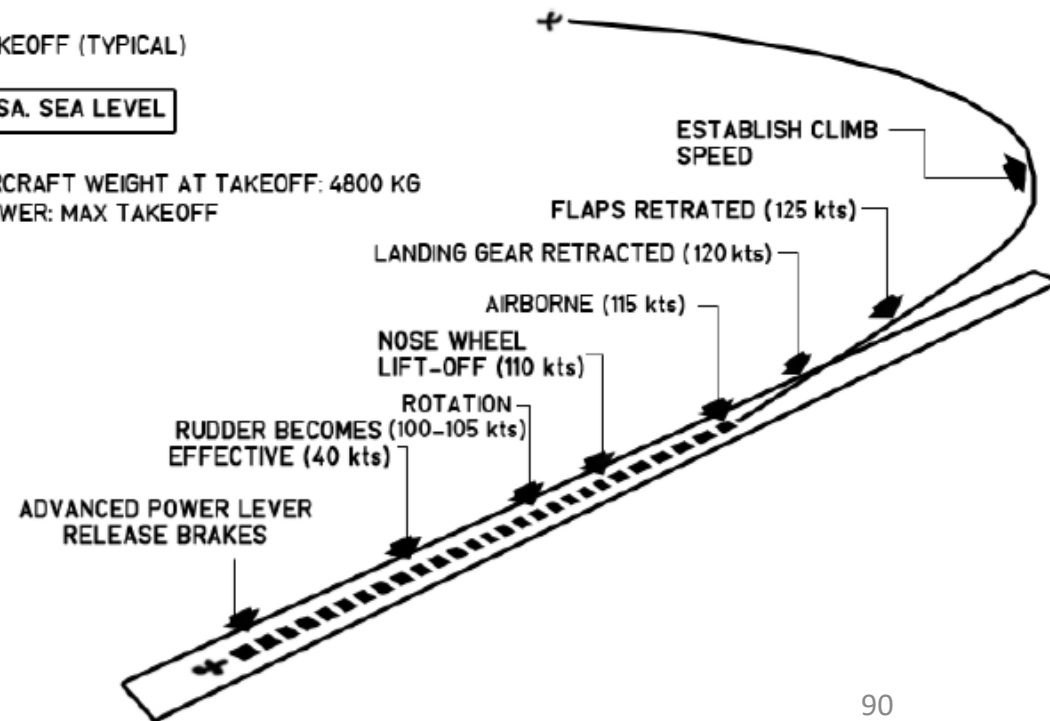


PART 5 - TAXI & TAKEOFF

TAKEOFF (TYPICAL)

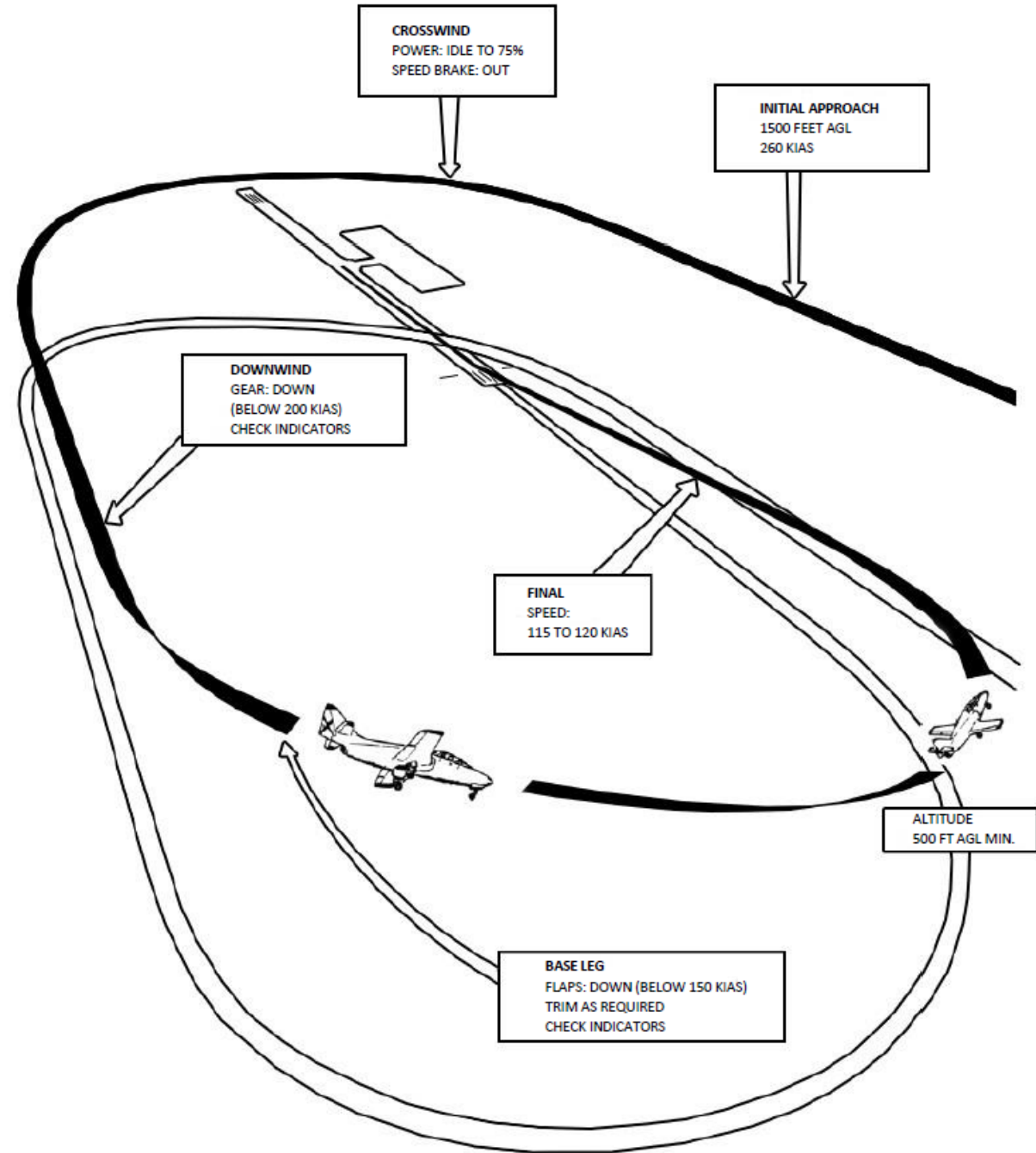
ISA. SEA LEVEL

AIRCRAFT WEIGHT AT TAKEOFF: 4800 KG
POWER: MAX TAKEOFF



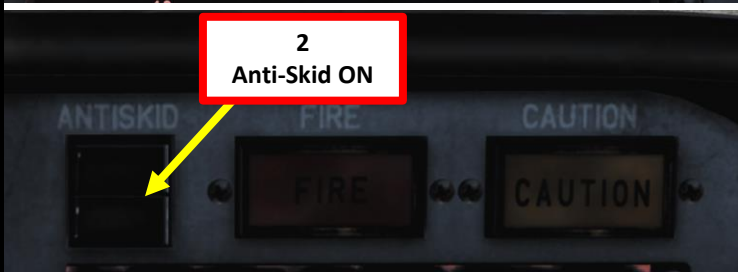
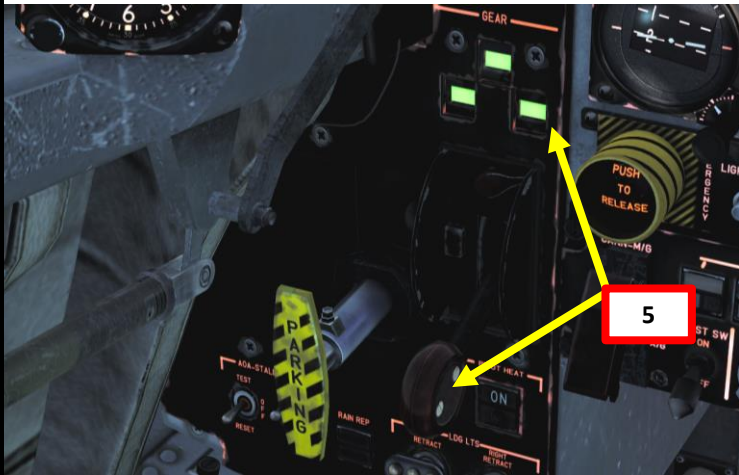
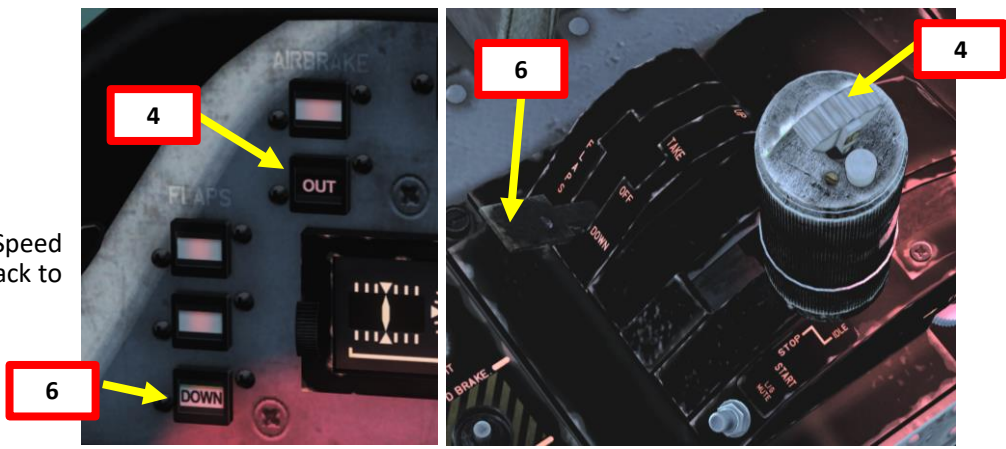
LANDING PROCEDURE

LANDING PATTERN (TYPICAL)



LANDING PROCEDURE

1. Set Engine Ignition Switch AFT to CONTINUOUS IGNITION (*IGNIC CONT*)
2. Set Anti-Skid switch – ON (OFF Light Extinguished)
3. Verify that the radio altimeter is ON
4. In the crosswind turn, set power between IDLE and 75 % N1 and deploy speed brake. Set the Speed Brake switch AFT to EXTEND, wait for the “OUT” indication to appear, then set Speed Brake back to Neutral (Middle) position.
5. On the downwind, deploy landing gear below 200 kts
6. On the base leg, deploy flaps (DOWN) below 150 kts.
7. Final approach speed should be between 115 and 120 kts



LANDING PROCEDURE

8. Trim aircraft to set a ON SPEED Angle of Attack. Use the AoA Indexer as a reference (green doughnut = On Speed).



INDICATOR	INDEXER	SPEED	ATTITUDE
		VERY SLOW	
		SLIGHTLY SLOW	
		ON SPEED	
		SLIGHTLY FAST	
		VERY FAST	

Figure 9-17 Angle-Of-Attack displays

LANDING PROCEDURE

9. Final approach speed should be between 115 and 120 kts. For landings on runways of non-critical length, aerodynamic braking may be used to conserve brakes and tyres.
10. Flare the aircraft at 110 kts over the threshold and touch down at 95 kts on the main landing gears.
11. Hold the nose wheel off the runway by progressive application of aft stick until, when fully aft, the nose wheel smoothly lowers to contact the runway. Apply brakes and counteract yaw and maintain directional control by use of rudder in combination with differential braking. Rudder effectiveness decreases with diminishing rollout speed.



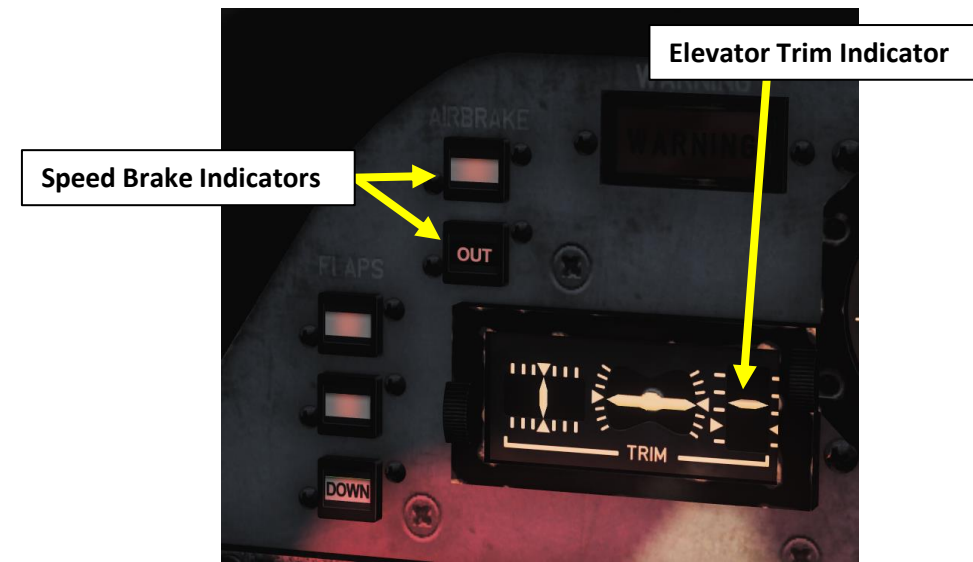
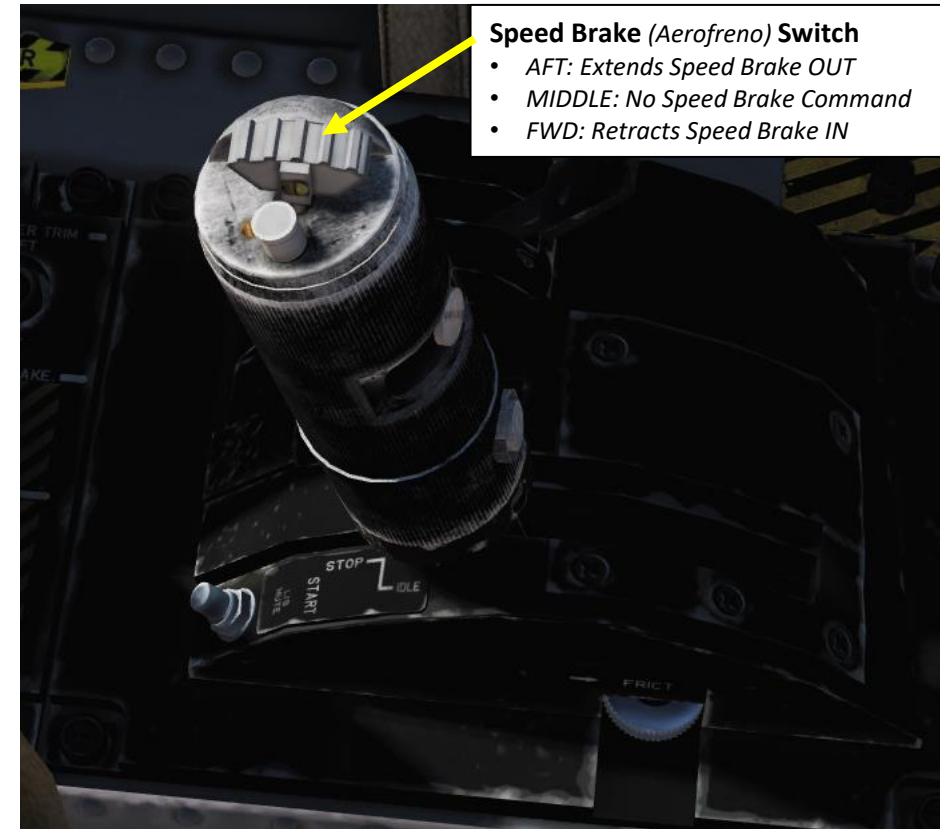
LANDING PROCEDURE

Important Note:

The trim system (*compensador*) is connected to the speed brake system. When you deploy the airbrake, the aircraft wants to pitch the nose up. The trim system wants to prevent a change in aircraft attitude due to the speed brake deployment, therefore the system trims the nose down to, well, compensate (d'uh!). The speed brake system automatically reduces the pitch change resulting from speed brake deployment.

After you deploy airbrakes, you have to make sure to **return the airbrake button on your joystick to the centre (neutral) position...** or the trim system will continue to perpetually trim the nose down. The same is true when retracting the airbrake except the trim system will continue to trim the nose up.

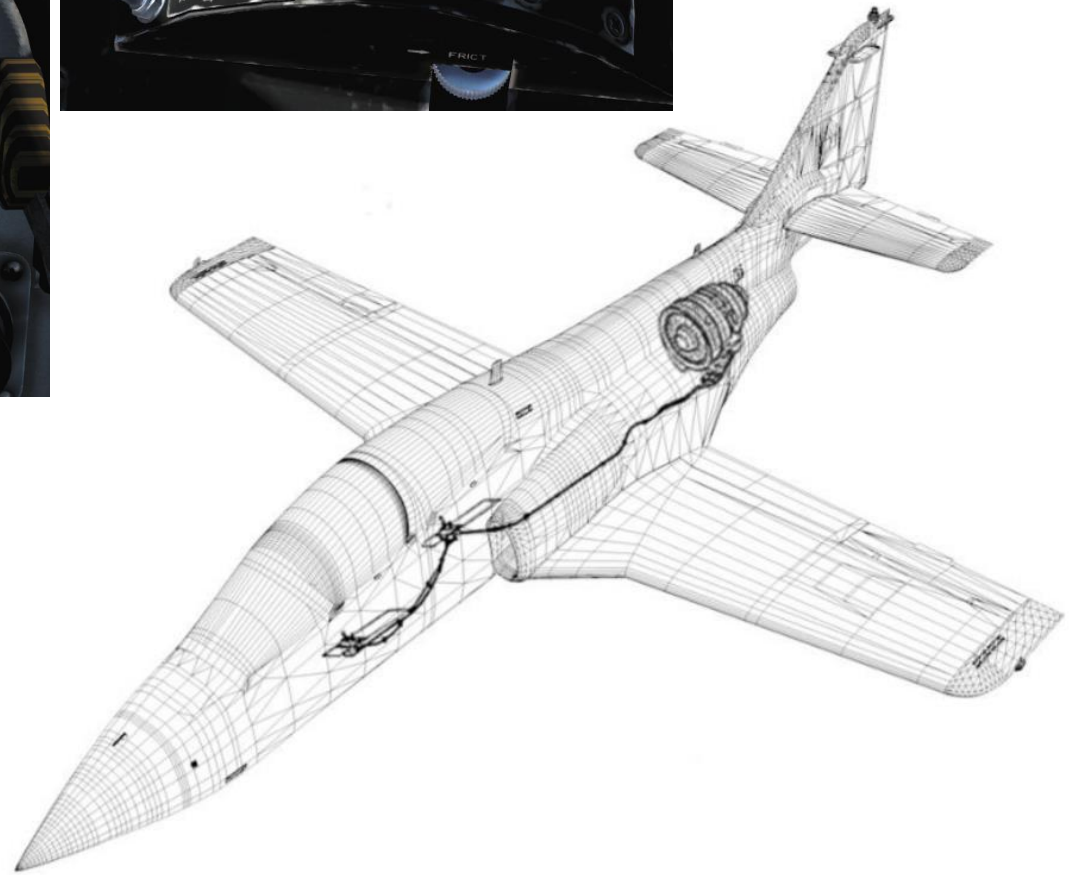
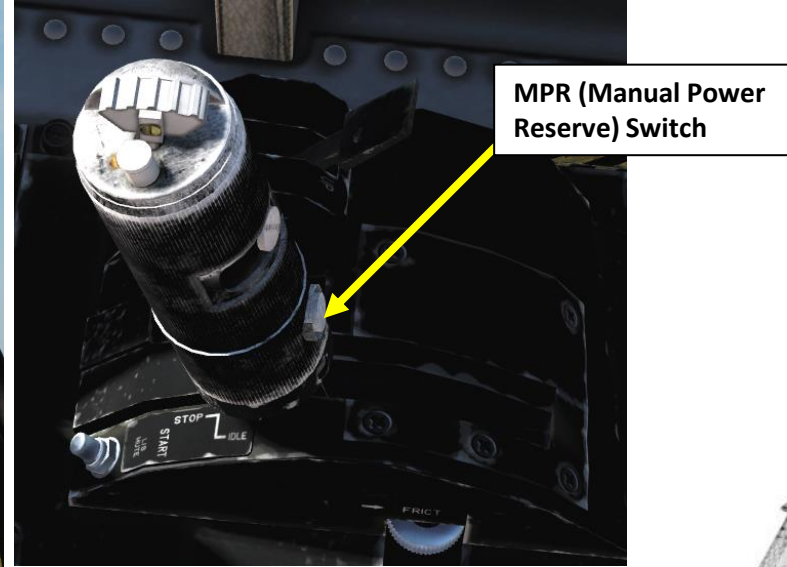
If you use a three-way switch and inadvertently leave the Speed Brake switch to IN or OUT, the stick trim system is overridden by the air brake trim commands and you will not be able to trim the aircraft. This makes an approach very difficult since you will be trimmed fully nose down when the brake is deployed, which makes flaring close to impossible and the aircraft becomes increasingly difficult to control in the pitch axis. Therefore, I advise you to always keep an eye on your Elevator Trim indicator when landing and to make sure that the aircraft is trimmed properly when landing.



GARRETT TFE 731-5-1J – INTRO

The C-101CC is powered by a Garrett TFE 731-5-1J single bypass turbofan engine, while the C-101EB uses a Garrett TFE 731-2-2J. The TFE731 was based on the core of the TSCP700, which was specifically developed for use as the auxiliary power unit (APU) on the McDonnell Douglas DC-10. The design featured two important factors: low fuel consumption, and low noise profiles that met the newly established U.S. noise abatement regulations.

The C-101CC has a MPR switch on the throttle, which allows the engine to use the Manual Power Reserve rating to increase thrust by about 400 lbs. MPR can be used when taking off from short runways. Take note that this switch is not present on the C-101EB.



ENGINE PERFORMANCE: STATIC SEA LEVEL (UNINSTALLED)				
Power	Temperature	Net Thrust lb (Max)	Specific Fuel Consumption lb/h/lb (Max)	Definition
Manual Power Reserve (MPR)	15°C (59°F)	4700	0,477	Maximum Emergency Thrust. 5 Min. Limit.
Maximum Takeoff	15°C (59°F)	4304	0,471	Maximum Emergency Thrust. 5 Min. Limit.
Maximum Climb	15°C (59°F)	4304	0,471	Maximum Climb Thrust. 30 Min. Limit.
Manual Power Reserve (MPR)	18,3°C (65°F)	4700	0,481	As above at 15° OAT.
Maximum Takeoff	18,3°C (65°F)	4304	0,475	
Maximum Climb	18,3°C (65°F)	4179	0,474	

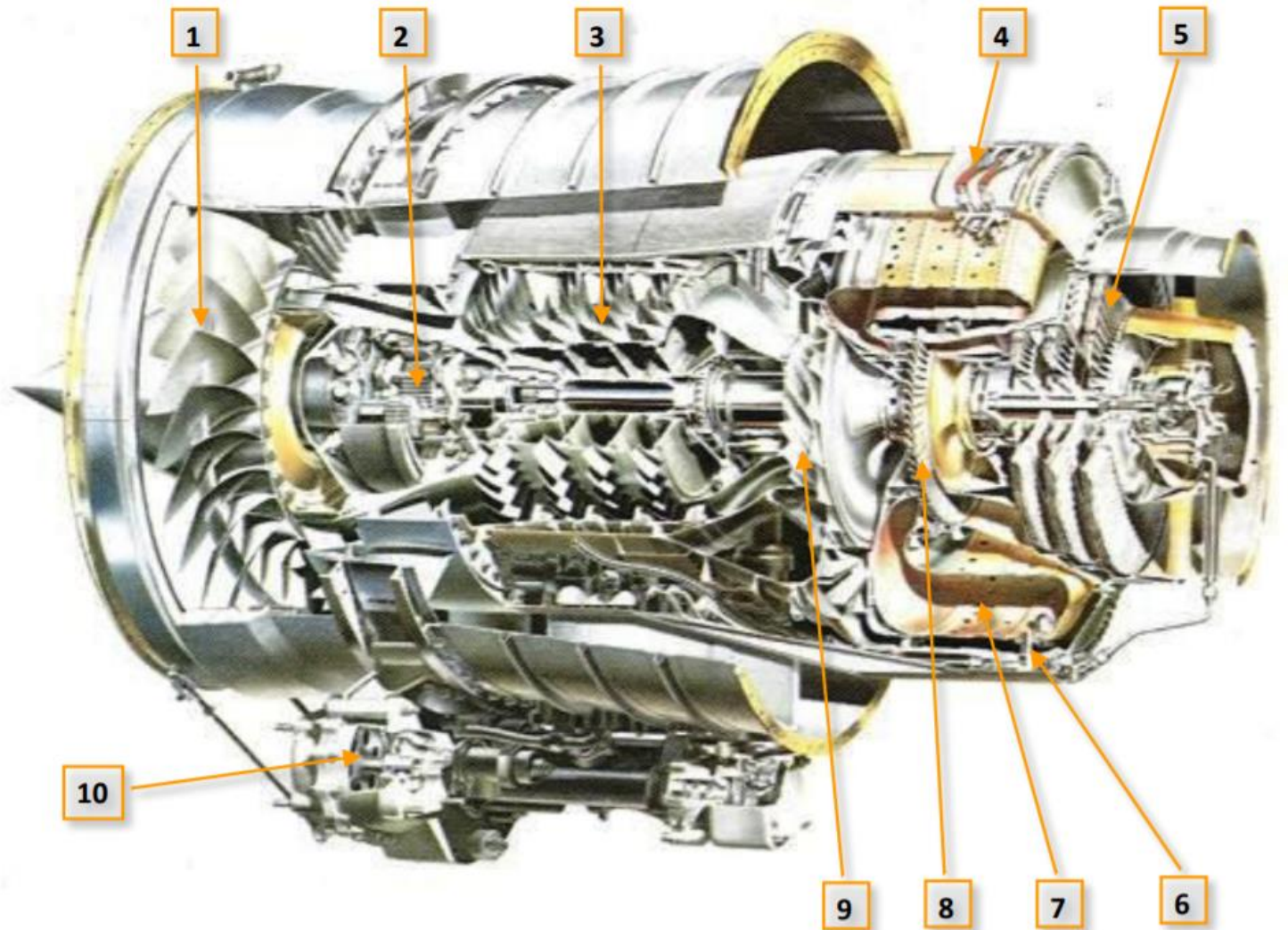
Figure 3-8 Power plant

GARRETT TFE 731-5-1J – COMPONENTS

Equipped with two mechanically independent spools, the low pressure (LP) spool consists of a fan and a four stage axial compressor driven by a three stage axial turbine, while the high pressure (HP) spool consists of a centrifugal compressor driven by an axial turbine, both of which are single stage. The exhaust and fan gases are discharged through independent concentric ducts. The accessory gearbox drives the starter generator and hydraulic pump by means of the HP spool.

There is an anti-surge valve that permits part of the LP compressor air to bleed to the fan duct. This is to avoid compressor stall or surge during certain conditions, like abrupt application of power that can affect the equilibrium of air through the LP spool and the pressure aft of the spool which can create instability of the air flow.

The engine is also equipped with an anti-ice system, which provides an air flow from the HP compressor into the fan nose cone. It also heats Pt2 and Tt2 sensors with electrical resistors.



- 1 FAN
- 2 PLANETARY REDUCTION GEARS
- 3 FOUR STAGE LOW PRESSURE AXIAL COMPRESSOR
- 4 FUEL MANIFOLD
- 5 LOW PRESSURE TURBINE
- 6 IGNITER
- 7 COMBUSTION CHAMBER
- 8 SINGLE STAGE HIGH PRESSURE AXIAL TURBINE
- 9 SINGLE STAGE HIGH PRESSURE RADIAL COMPRESSOR
- 10 ACCESSORY GEARBOX

Figure 3-9 Garrett TFE 731-2-2J

GARRETT TFE 731-5-1J – ENGINE LIMITS

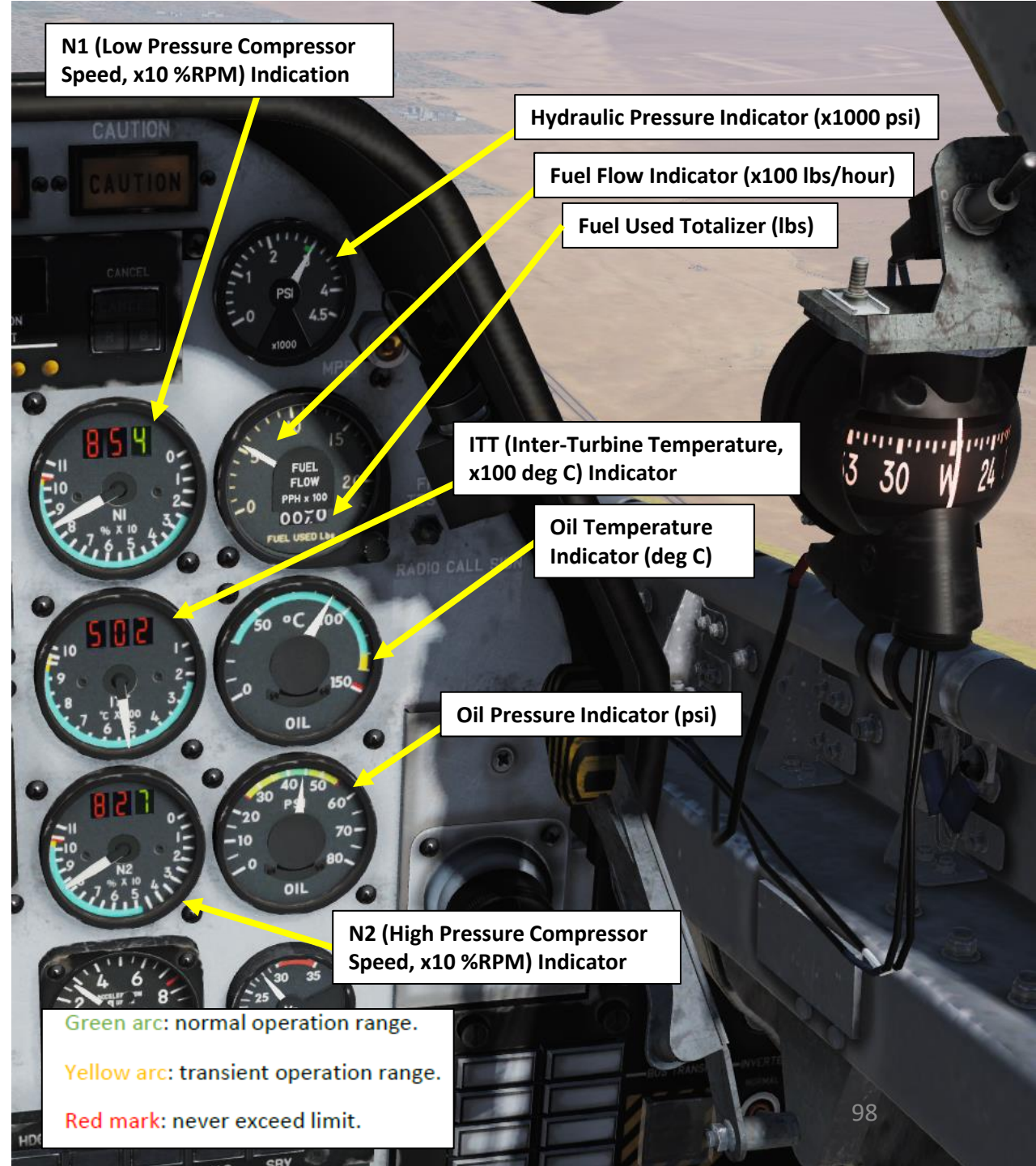
Interestingly, one of the challenges of flying the C-101CC is the fact that the engine is underpowered for most aircraft configurations. The takeoff run and landing length are quite long, the spool-up and spool-down time of the engine is long and the aircraft really struggles to gain airspeed and altitude when heavily loaded. When taking off, it is very important to wait for the engine to spool up to its maximum RPM before releasing the brakes and beginning your takeoff roll. Also, keep in mind that negative Gs will cause oil pressure and fuel pressure drop.

The C-101EB and C-101CC engines have different ITT (Inter Turbine Temperature) limits.

- **C-101EB:** the TF731-2-2J can maintain an ITT of 830 °C for a maximum of 5 minutes. If you exceed this limitation, you are likely to suffer an engine stall and engine fire if you persist in engine mishandling. Be careful: there are no engine limiters that prevent you from reaching this limit.
- **C-101CC:** in practice, the TF731-5-1J cannot reach its ITT limit. According to subject matter experts (SME), C-101CC pilots never thought about exceeding engine limits and could use full power for as long as needed.

LIMITATIONS

ITT	
ITT DURING START	860°C
ITT LIMITATIONS	860°C for 5 min during takeoff 796-832°C for 30 min 795°C maximum continuous
OIL	
OIL PRESSURE	IDLE between 25 and 46 psi NORMAL between 38 and 46 psi MAXIMUM 55 psi for 3 min
OIL TEMPERATURE	30°C MINIMUM 127°C MAXIMUM until 30000 ft 149°C MAXIMUM for 2 min at any altitude
HYDRAULIC	
HYDRAULIC PRESSURE	NORMAL 2850-3050 psi TRANSIENT 3050-3600 psi MAXIMUM 3600 psi
GROUND START CYCLES	
First start attempt:	30 sec ON, 1 min OFF
Second start attempt:	30 sec ON, 1 min OFF
Third start attempt:	30 sec ON, 30 min OFF



N1 (Low Pressure Compressor Speed, x10 %RPM) Indication

Hydraulic Pressure Indicator (x1000 psi)

Fuel Flow Indicator (x100 lbs/hour)

Fuel Used Totalizer (lbs)

ITT (Inter-Turbine Temperature, x100 deg C) Indicator

Oil Temperature Indicator (deg C)

Oil Pressure Indicator (psi)

N2 (High Pressure Compressor Speed, x10 %RPM) Indication

Green arc: normal operation range.

Yellow arc: transient operation range.

Red mark: never exceed limit.

AERODYNAMICS & STALLS

Maximum speed is Mach 0.8 or 450 KIAS and maximum ceiling can be up to 45000 feet, depending on aircraft weight. The aircraft presents longitudinal and directional stability within the CG range in any internal load configuration. Stability is neutral in the lateral axis, thus eliminating special pilot techniques other than a frequent reference to the lateral attitude. Maneuverability is high, ailerons are hydraulically powered by servo-actuators which permit rather high roll rates. Pitch trim is by action of the horizontal stabilizer and roll trim by differential aileron deflection, both are electrically operated. The speed brake provides rapid deceleration and is operable at all aircraft speeds and attitudes

A stall can be entered without requiring full control stick back pressure. Pre-stall buffet is felt at about 5 KIAS before the stall with flaps and gear retracted, while the stall warning system activates at 10-15 KIAS above the stall in level flight. With the control stick fully back and centered, the roll oscillations are more pronounced. Aileron and rudder remain effective during the post-stall regime, and the aircraft remains controllable, unless full aileron and/or rudder are applied. Recovery response is effected immediately by centering the flight controls. Accelerated stalls are preceded by a clear aerodynamic buffet. The aircraft does not present any adverse characteristics during the approach to the stall or the recovery, which is performed by releasing control stick pressure.

The C-101 has a nice (and frequently heard) stick shaker (technically, it might just be a rudder pedal shaker) to let you know when you are demanding a bit too much lift from the wings. The buzz of the shaker will let you know to ease some pressure off the stick or risk destroying what little margin to the stall remains. The straight wing is forgiving though. If you allow yourself to ease into the stall, you can pin the stick full aft and the plane will just mush ahead with a very high sink rate. A more aggressive stall entry with some speed and a snatch on the stick with some rudder input will send it tumbling off on a wing as one would expect.

The C-101's straight wing gives it very good low speed handling and a pretty fair turn rate, but it won't hold energy for long if you put a lot of G-loading on it.

STALL SPEEDS - KIAS						
FLAPS POSITION (°)	GEAR	BANK ANGLE (°)	REMAINING FUEL - KG			
			1015	2115	3220	4100
0	RETRACTED	0	97	103	108	113
		30	104	110	116	121
		45	115	122	129	134
		60	137	145	153	159
10	EXTENDED	0	91	96	102	106
		30	98	104	109	113
		45	108	115	121	126
		60	129	136	144	149
30	EXTENDED	0	84	90	94	98
		30	91	96	101	105
		45	100	106	112	117
		60	119	127	133	139

Figure 7-1 Stall speeds



SPINS, SPEED BRAKE AND DIVES

Inadvertent spins are unlikely. To **enter a spin**, the control stick and rudder must be deliberately held at full travel. In a normal spin, the aircraft assumes a nose down attitude with slow angular velocity. A flat spin (high angle of attack) is difficult to enter and can only be maintained momentarily. The procedure to deliberately enter a spin is the following:

1. Control Stick – Fully Back
2. Rudder – Full Travel
3. Ailerons – Centered

Engine thrust has little effect on spin characteristics or recovery, neither does the spin cause engine flame-out or surge. Spin recovery can be accomplished by centering stick and rudder; recovery is rapid and altitude loss does not normally exceed 2000'. In case of a more abrupt spin, the recovery can be forced by applying opposite rudder to the direction of rotation and simultaneously pushing the control stick forward. Entering an inverted spin is unlikely. In case of loss of control, it may be difficult to determine the direction of rotation. It may be useful to observe the turn needle of the turn and bank indicator as it always indicates the direction of spin rotation. The recovery is accomplished by pulling the control stick fully back and simultaneously applying and holding full rudder opposite to the direction of the turn.

Speed brake extension causes a nose-up moment that increases with airspeed. A switch in the speed brake circuit automatically activates the pitch trim to compensate for the moment change thus eliminating manual trim input or control stick forces. To read more about this, please consult the LANDING section of this guide.

No difficulties arise at **maximum diving speed** as stability is not noticeably influenced by compressibility. Aerodynamic buffeting appears at Mach numbers close to the limit, becoming strong at Mach 0.8. The recommended dive recovery procedure consists of: power reduction, speed brake extension and pull-up with elevators. Take into account that altitude loss during recovery can be very high. For example: near 5000 ft at 4 Gs and near 4000 ft at 6 Gs, in both cases at maximum airspeed and with 1015 lbs of remaining fuel.

SPEED LIMITATIONS
FLAPS TAKEOFF 190 kts
FLAPS DOWN 150 kts
LANDING GEAR 200 kts
LANDING LIGHTS 200 kts
MAX with outer wing tanks empty: Mach 0.8 or 450 kts
MAX with outer wing tanks full: Mach 0.7 or 350 kts
MAX with aileron servo-actuators inoperative: Mach 0.65 or 300 kts

ACCELERATION LIMITATIONS
POSITIVE +7.5 Gs
NEGATIVE -3.9 Gs
Without servo-actuators: +5 Gs
Unsymmetrical maneuvers: +5 Gs
In zero or negative-G flight: 30 seconds



ARMAMENT OVERVIEW

AIR-TO-GROUND MISSILE

NAME	DESCRIPTION
Sea Eagle	Inertial guidance system with active radar homing anti-ship missile

AIR-TO-AIR MISSILES

NAME	DESCRIPTION
AIM-9M	Short range IR guided missile
AIM-9P	Short range IR guided missile
R550 Magic II	Short range IR guided missile

GUNS

NAME	DESCRIPTION
AN-M3	12.7 mm (0.5 in) twin machine guns (440 rounds)
DEFA 553	30 mm cannon (130 rounds)

ROCKETS

NAME	DESCRIPTION
Hydra	19 x 70 mm (2.75 in) unguided rockets
Hydra	7 x 70 mm (2.75 in) unguided rockets

BOMBS (UNGUIDED)	
NAME	DESCRIPTION
BDU-33	Practice bombs
BIN-200	200 kg (441 lbs) unguided low-drag general-purpose bomb
BR-250	250 kg (451 lbs) unguided low-drag general-purpose bomb
BR-500	500 kg (1102 lbs) unguided low-drag general-purpose bomb
BL755	450 kg (1000 lbs) unguided cluster bomb
BLG-66 Belouga	305 kg (672 lbs) unguided anti-runway cluster bomb
FAB-100	100 kg (221 lbs) unguided low-drag general-purpose bomb
FAB-250	250 kg (451 lbs) unguided low-drag general-purpose bomb
Mk-82	227 kg (500 lbs) unguided low-drag general-purpose bomb
Mk-84	925 kg (2039 lbs) unguided low-drag general-purpose bomb



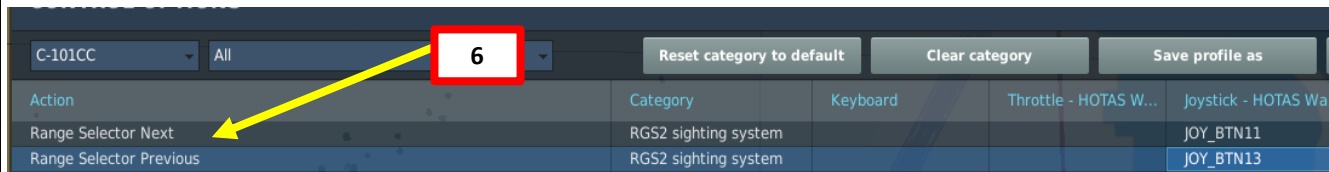
AIR-TO-AIR GUN

1. Verify that a gun pod has been installed on the aircraft
2. Set Fixed Weapons switch to A/A (UP)
3. Set Master Arm switch – ON (UP)
4. Set Gunsight Power switch – ON (UP)
5. Set Gunsight Mode switch – AUTO (UP)
6. Adjust Gunsight range as desired using the throttle twist grip
7. Verify that the ERR (Error) light is extinguished

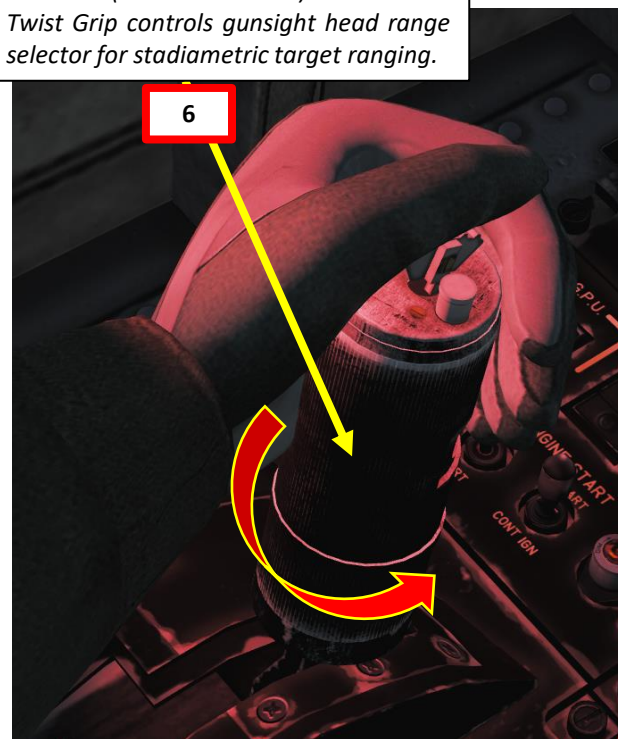


Gun Pod Selected

Ammunition Count



Throttle (Mando de Gases)
Twist Grip controls gunsight head range selector for stadiametric target ranging.



WEAPON MODE	RETICLE PATTERN	RANGE/FUNCTION	SIGHT LINE	SELECTED FROM
A-A GUN	[Reticle Pattern]	700 ft	Lead Computed	Range Selector
A-A GUN	[Reticle Pattern]	1250 ft	Lead Computed	Range Selector
A-A GUN	[Reticle Pattern]	1800 ft	Lead Computed	Range Selector
A-A GUN	[Reticle Pattern]	Snap Shot	Pre-set	Range Selector
A-G GUN	[Reticle Pattern]	2000 ft	Lead Computed & pre-set or manually set depression	Weapon Control CU
A-G BOMB	[Reticle Pattern]		Pre-set or manually set depression	Weapon Control CU
A-G ROCKET	[Reticle Pattern]		Lead Computed & pre-set or manually set depression	Weapon Control CU
ALL	[Reticle Pattern]	FIRING	103	Trigger

Figure 9-36 Reticle Pattern

AIR-TO-AIR GUN

8. Fly the aircraft to align the gunsight on the target.
9. Flip safety catch (Trigger Safety Catch – Unlock) and press Gun Trigger (Fixed Weapons Trigger) to fire (Spacebar)

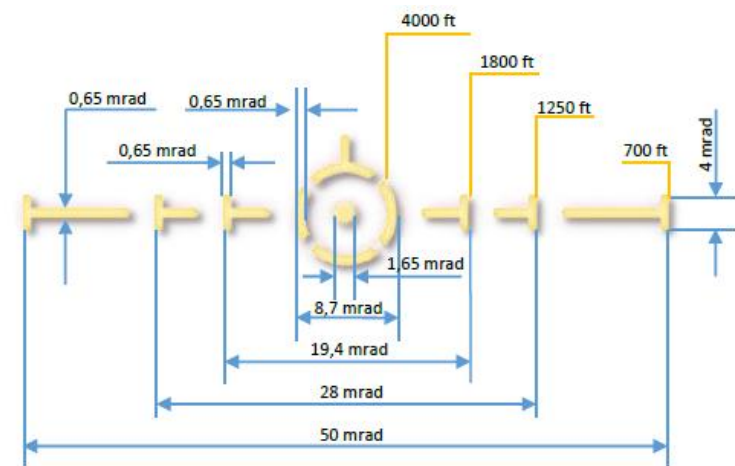
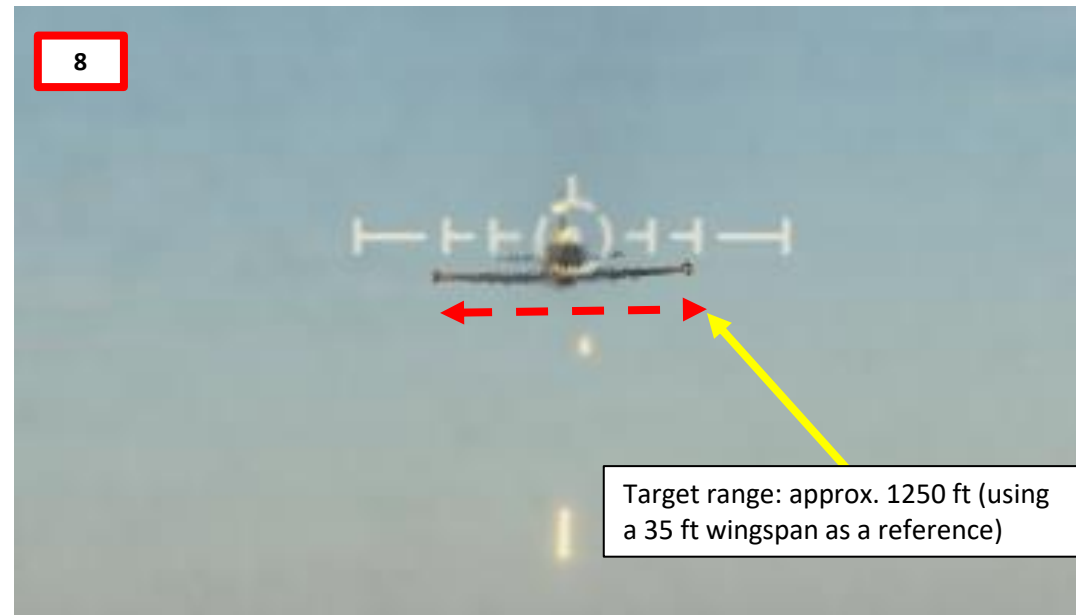


Figure 9-35 Reticule

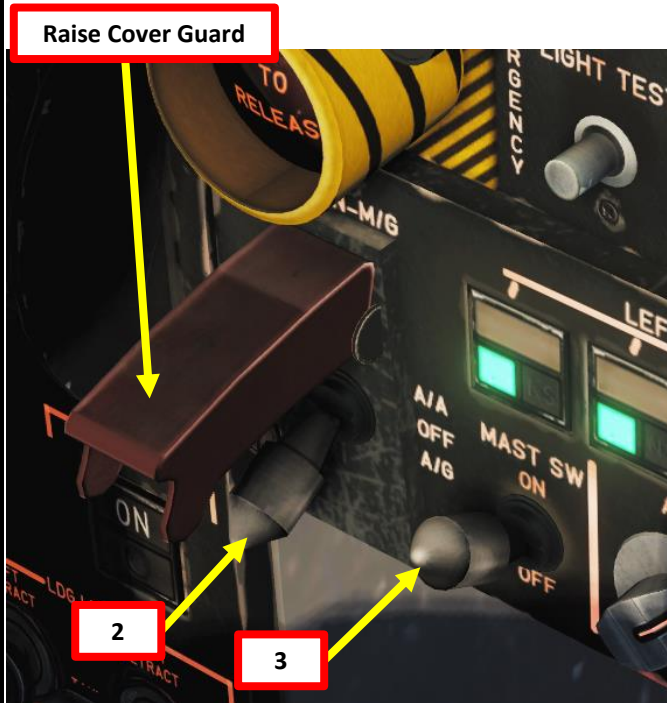
The pattern corresponds to the apparent size of a 35ft-wingspan aircraft at four fixed ranges.



Target range: approx. 1250 ft (using a 35 ft wingspan as a reference)

AIR-TO-GROUND GUN

1. Verify that a gun pod has been installed on the aircraft
2. Set Fixed Weapons switch to A/G (DOWN)
3. Set Master Arm switch – ON (UP)
4. Set Gunsight Power switch – ON (UP)
5. Set Gunsight Mode switch – AUTO (UP)
6. Verify that the ERR (Error) light is extinguished
7. Fly the aircraft to align the gunsight on the target. Your gunsight will be set to a range of 2000 ft.
8. Flip safety catch (Trigger Safety Catch – Unlock) and press Gun Trigger (Fixed Weapons Trigger) to fire (Spacebar)



WEAPON MODE	RETICLE PATTERN	RANGE/FUNCTION	SIGHT LINE	SELECTED FROM
A-A GUN		700 ft	Lead Computed	Range Selector
A-A GUN		1250 ft	Lead Computed	Range Selector
A-A GUN		1800 ft	Lead Computed	Range Selector
A-A GUN		Snap Shot	Pre-set	Range Selector
A-G GUN		2000 ft	Lead Computed & pre-set or manually set depression	Weapon Control CU
A-G BOMB		Pre-set or manually set depression	Pre-set or manually set depression	Weapon Control CU
A-G ROCKET		Lead Computed & pre-set or manually set depression	Lead Computed & pre-set or manually set depression	Weapon Control CU
ALL		FIRING		Trigger

Figure 9-36 Reticle Pattern

C-101CC
AVIOJET

PART 9 – WEAPONS & ARMAMENT

AIR-TO-GROUND GUN

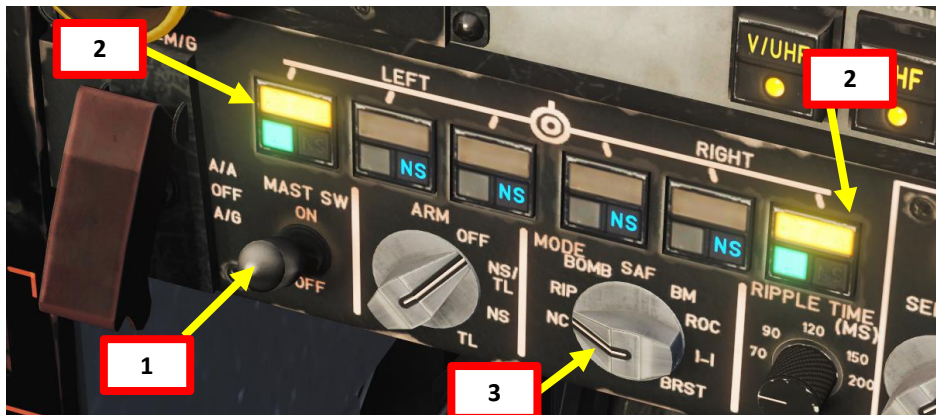


AIR-TO-AIR MISSILE

1. Set Master Arm switch – ON (UP)
2. Select pylons with air-to-air missiles by pressing the Pylon Selector buttons
3. Set Weapon Mode Selector to NC
4. Verify that the ERR (Error) light is extinguished
5. Get close to your target. A low-pitch growl sound indicates that the missile is armed and seeking a heat signature.
6. Once the low-pitch growl sound turns into a high-pitch growl, the missile has detected a heat signature.
7. Flip the safety guard (Stores Release Guard - Open) and press the Weapons Release Trigger (Stores Release Button) to fire your missile (RALT+Space)



Figure 9-40 Pylon Selector/Status Indicator Buttons



AIR-TO-AIR MISSILE

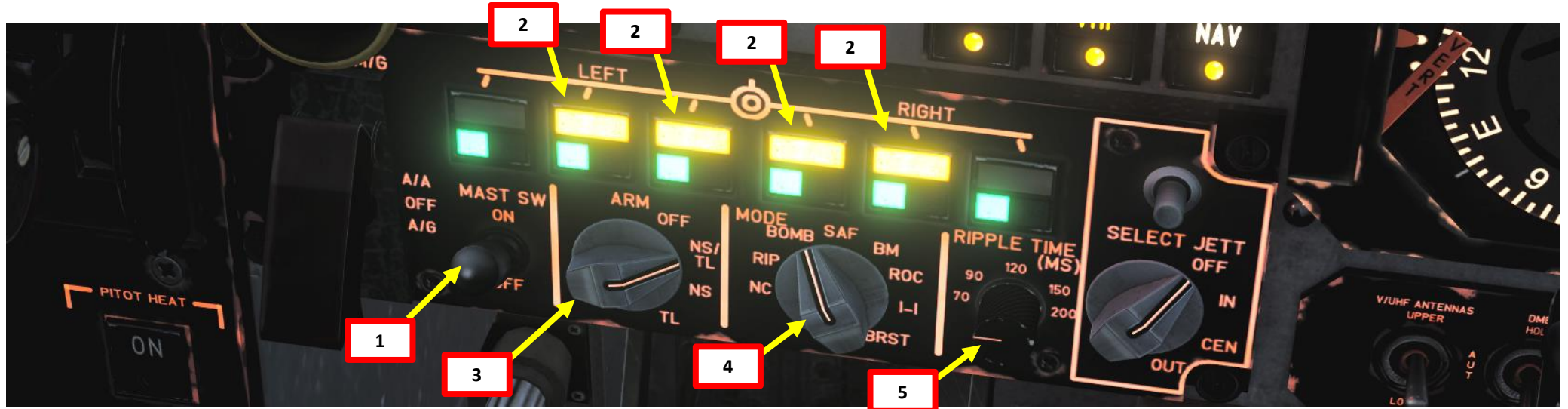


BOMBS

1. Set Master Arm switch – ON (UP)
2. Select pylons with bombs by pressing the Pylon Selector buttons
3. Set Bomb Arming Selector to NS/TL
4. Set Weapon Mode Selector to BOMB (or RIP if using container with 4 bomblets)
5. If using a container with 4 bomblets, set Ripple Time as desired.
6. Verify that pylons are selected, the ARM light is illuminated and that the ERR (Error) light is extinguished

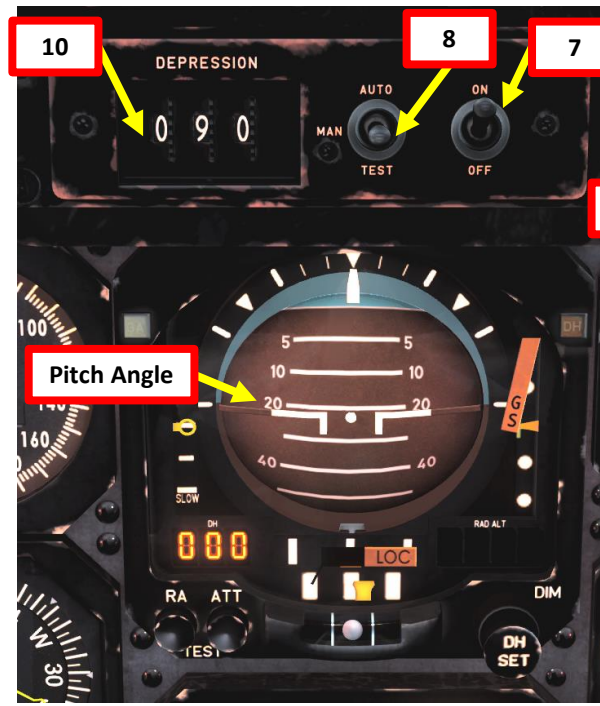


Figure 9-40 Pylon Selector/Status Indicator Buttons



BOMBS

7. Set Gunsight Power switch – ON (UP)
8. Set Gunsight Mode switch – MANUAL (MIDDLE)
9. Select desired bombing profile in the tables.
10. Set a depression angle of 90 mrad on the gunsight.



Mk-82 BOMBS	
5500 Kg 250 KTS DIVE -20°	
HEIGHT (ft)	DEPRESSION ANGLE (mrad)
250	70
500	90
750	110

Mk-82 BOMBS	
5500 Kg 250 KTS DIVE -30°	
HEIGHT (ft)	DEPRESSION ANGLE (mrad)
500	70
750	90
1000	110

Mk-82 BOMBS	
5500 Kg 300 KTS DIVE -30°	
HEIGHT (ft)	DEPRESSION ANGLE (mrad)
500	30
750	50
1000	70
1500	110
2000	120

Mk-82 BOMBS	
5500 Kg 300 KTS DIVE -40°	
HEIGHT (ft)	DEPRESSION ANGLE (mrad)
1000	40
1500	70
2000	90
2500	100
3000	120

Mk-82 BOMBS	
5500 Kg 350 KTS DIVE -30°	
HEIGHT (ft)	DEPRESSION ANGLE (mrad)
750	30
1000	50
1500	70
2000	90
2500	110
3000	120

Mk-82 BOMBS	
5500 Kg 350 KTS DIVE -40°	
HEIGHT (ft)	DEPRESSION ANGLE (mrad)
1000	20
1500	40
2000	50
2500	80
3000	90
4000	110
4500	120

Mk-82 BOMBS	
5500 Kg 400 KTS DIVE -30°	
HEIGHT (ft)	DEPRESSION ANGLE (mrad)
1000	20
1500	60
2000	60

Mk-82 BOMBS	
5500 Kg 400 KTS DIVE -40°	
HEIGHT (ft)	DEPRESSION ANGLE (mrad)
750	25
1000	40
1250	45
1500	55
1750	65
2000	70
2250	85
2500	90
2750	100
3000	110
3500	120

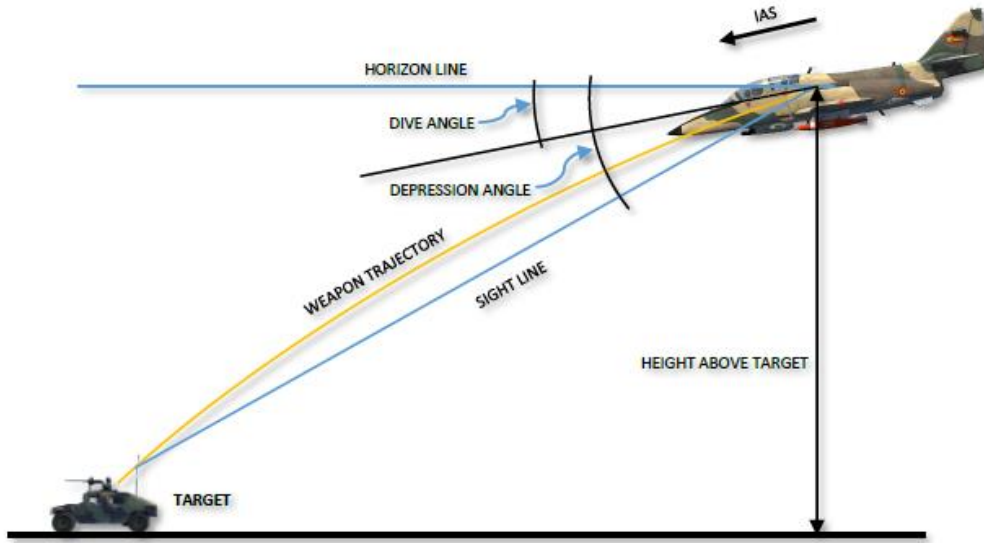
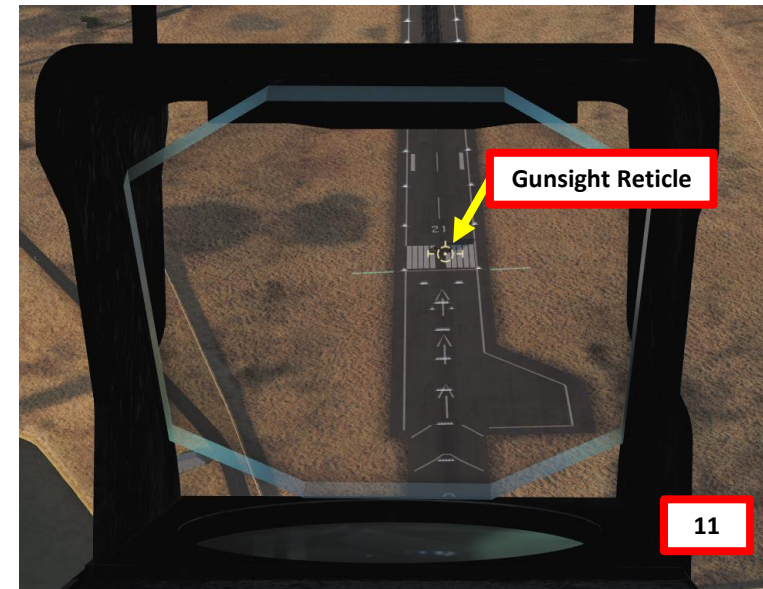


Figure 9-45 Sight Line and Depression Angle

BOMBS

11. Perform a 20 deg dive at 250 kts.
12. When reaching 500 ft, flip the safety guard (Stores Release Guard - Open) and press the Weapons Release Trigger (Stores Release Button) to drop your bomb (RALT+Space)



WEAPON MODE	RETICLE PATTERN	RANGE/FUNCTION	SIGHT LINE	SELECTED FROM
A-A GUN		700 ft	Lead Computed	Range Selector
A-A GUN		1250 ft	Lead Computed	Range Selector
A-A GUN		1800 ft	Lead Computed	Range Selector
A-A GUN		Snap Shot	Pre-set	Range Selector
A-G GUN		2000 ft	Lead Computed & pre-set or manually set depression	Weapon Control CU
A-G BOMB			Pre-set or manually set depression	Weapon Control CU
A-G ROCKET			Lead Computed & pre-set or manually set depression	Weapon Control CU
ALL		FIRING		Trigger

Figure 9-36 Reticle Pattern

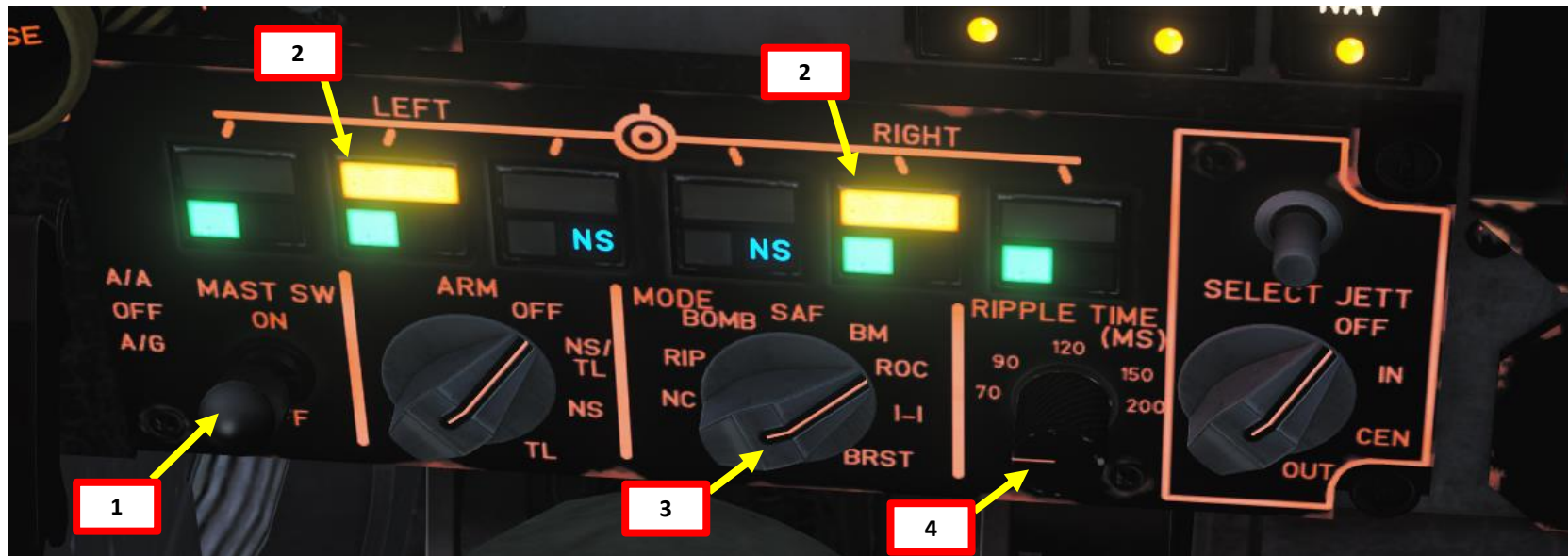
ROCKETS

1. Set Master Arm switch – ON (UP)
2. Select pylons with bombs by pressing the Pylon Selector buttons
3. Set Weapon Mode Selector to ROCKET (or BURST if using multiple rockets per trigger press)
4. If using BURST, set Ripple Time as desired.
5. Verify that pylons are selected and that the ERR (Error) light is extinguished

Pylon Selector / Status Indicator Pushbuttons



Figure 9-40 Pylon Selector/Status Indicator Buttons



ROCKETS

6. Set Gunsight Power switch – ON (UP)
7. Set Gunsight Mode switch – MANUAL (MIDDLE)
8. Select desired bombing profile in the tables.
9. Set a depression angle of 25 mrad on the gunsight.



151-HE ROCKETS	
5500 Kg 300 KTS DIVE -10°	
HEIGHT (ft)	DEPRESSION ANGLE (mrad)
750	25
1350	30
2600	35
3000	40
4200	45
4500	50
4800	55
5200	60
5600	65
6100	70
6600	75

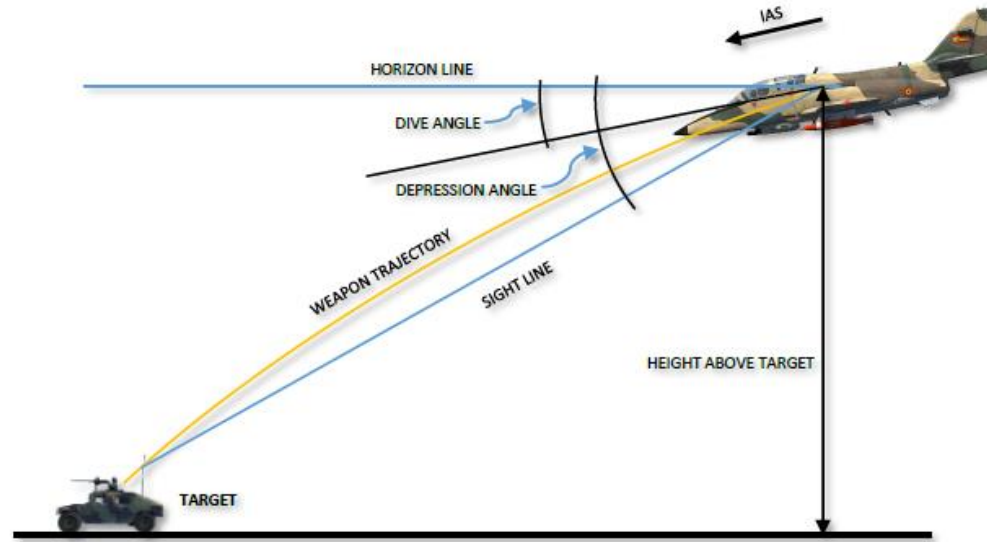


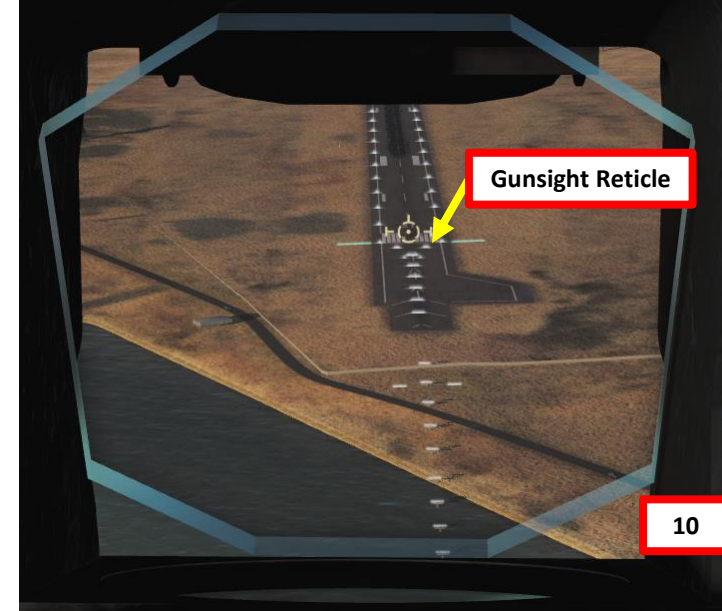
Figure 9-45 Sight Line and Depression Angle

151-HE ROCKETS	
5500 Kg 300 KTS DIVE -15°	
HEIGHT (ft)	DEPRESSION ANGLE (mrad)
250	25
1300	30
2300	35
3400	40
4000	45
4700	50
5300	60
6500	70

Figure 9-44 Depression angle tables

ROCKETS

- 10. Perform a 10 deg dive at 300 kts.
- 11. When reaching 750 ft, flip the safety guard (Stores Release Guard - Open) and press the Weapons Release Trigger (Stores Release Button) to fire your rockets (RALT+Space)



WEAPON MODE	RETICLE PATTERN	RANGE/FUNCTION	SIGHT LINE	SELECTED FROM
A-A GUN		700 ft	Lead Computed	Range Selector
A-A GUN		1250 ft	Lead Computed	Range Selector
A-A GUN		1800 ft	Lead Computed	Range Selector
A-A GUN		Snap Shot	Pre-set	Range Selector
A-G GUN		2000 ft	Lead Computed & pre-set or manually set depression	Weapon Control CU
A-G BOMB			Pre-set or manually set depression	Weapon Control CU
A-G ROCKET			Lead Computed & pre-set or manually set depression	Weapon Control CU
ALL		FIRING	114	Trigger

Figure 9-36 Reticle Pattern

AIR-TO-GROUND “SEA EAGLE” ANTI-SHIP MISSILE

MISSION EDITOR PREPARATION

The Sea Eagle missile is simulated as a fire-and-forget anti-ship missile with preset homing coordinates. These coordinates to the target need to be entered via the Mission Editor.

1. Create a Ship and a C-101CC in the mission editor.
2. Create a waypoint near the ship, and set C-101CC “TASK” field to “Anti-Ship Strike”.
3. Then, click on “WAYPOINT EDIT”, “ADVANCED (WAYPOINT ACTIONS)”, and click “ADD”.
4. Set “TYPE” to “PERFORM TASK”
5. Set “ACTION” to “ATTACK UNIT”
6. Select the ship in the “GROUP” and “UNIT” fields.

And that’s it! Your missile has its coordinates. You just need to arm the missile and fire it at a range below 60 nm.



The screenshot displays the Mission Editor interface. On the left, a map shows a "Russian Ship" (red icon) and a waypoint "1" (white circle). A yellow "F" icon with a "0" is positioned above the ship. A red box labeled "2" points to the "TASK" field in the "AIRPLANE GROUP" panel, which is set to "Anti-ship Strike". A red box labeled "3a" points to the "ADD" button in the "ADVANCED (WAYPOINT ACTIONS)" panel. A red box labeled "3b" points to the "EDIT" button in the same panel. A red box labeled "3c" points to the "ADD" button in the "ADVANCED (WAYPOINT ACTIONS)" panel. A red box labeled "4" points to the "TYPE" field in the "Perform Task" panel, which is set to "Perform Task". A red box labeled "5" points to the "ACTION" field in the "Attack Unit" panel, which is set to "Attack Unit". A red box labeled "6" points to the "GROUP" and "UNIT" fields in the "Attack Unit" panel, which are both set to "Russian Ship 1" and "Russian Ship" respectively.

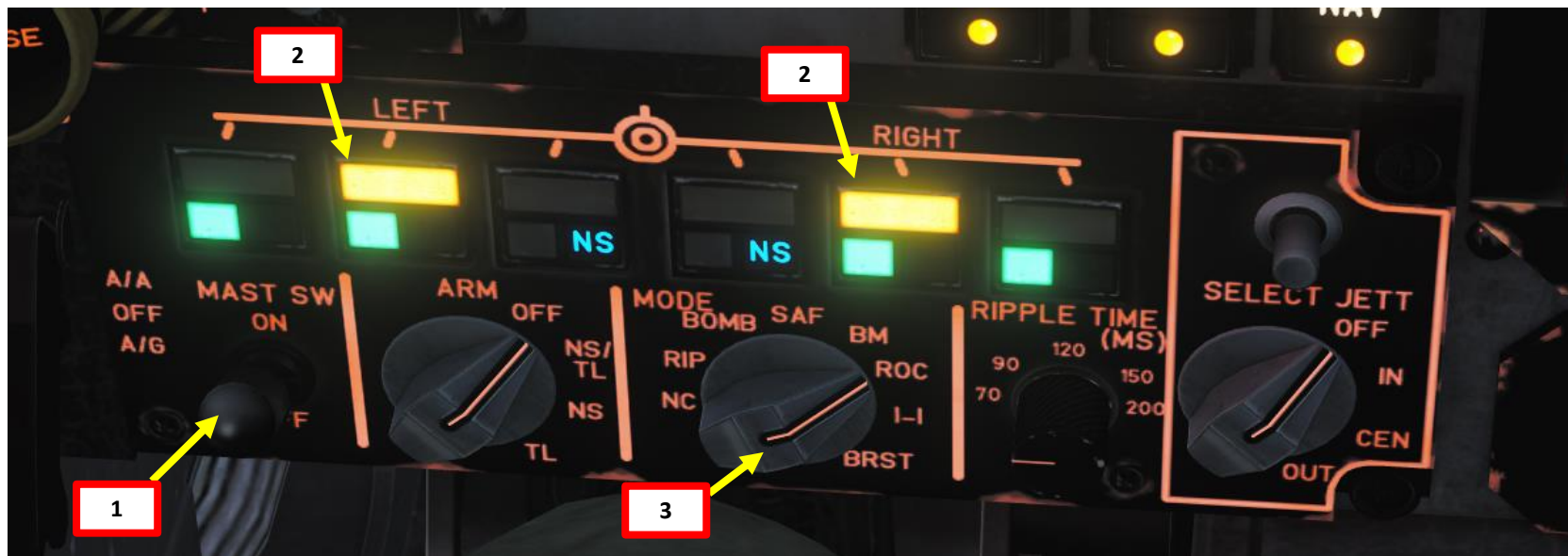
AIR-TO-GROUND “SEA EAGLE” ANTI-SHIP MISSILE

1. Set Master Arm switch – ON (UP)
2. Select pylons with bombs by pressing the Pylon Selector buttons
3. Set Weapon Mode Selector to ROCKET
4. Verify that pylons are selected and that the ERR (Error) light is extinguished

Pylon Selector / Status Indicator Pushbuttons



Figure 9-40 Pylon Selector/Status Indicator Buttons



AIR-TO-GROUND “SEA EAGLE” ANTI-SHIP MISSILE

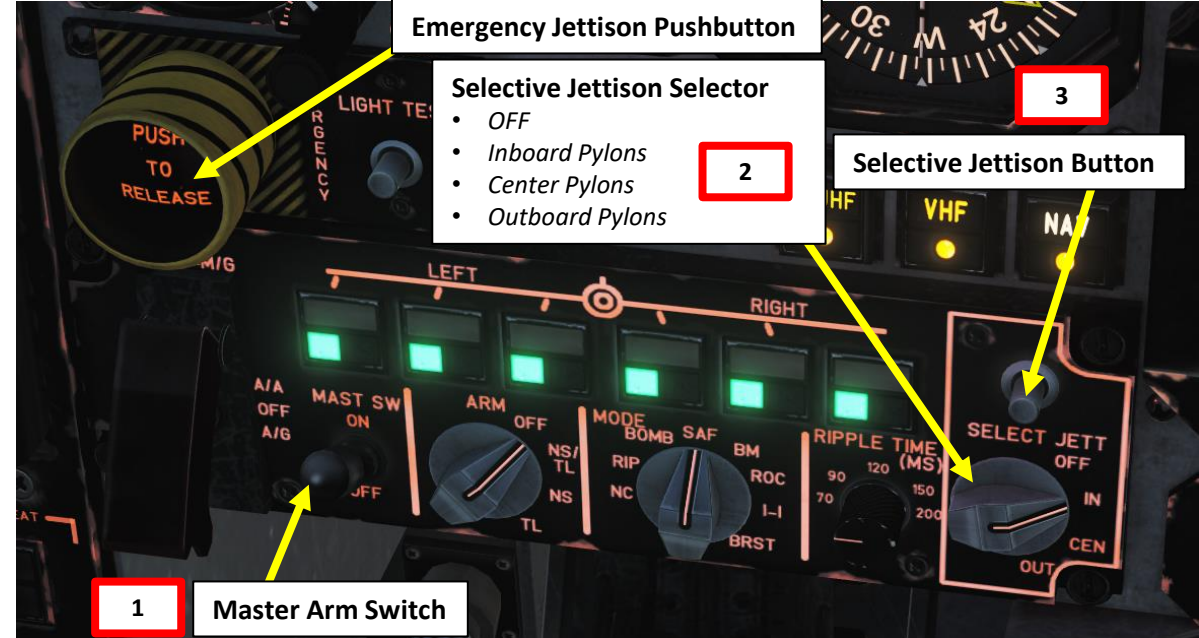
- When you are less than 60 nm from the target, flip the safety guard (Stores Release Guard - Open) and press the Weapons Release Trigger (Stores Release Button) to launch your missile (RALT+Space)



HOW TO JETTISON ORDNANCE

1. Set Master Arm Switch – ON (UP)
2. Select desired ordnance to be jettisoned using the Selective Jettison Selector. As an example, setting the selector to “IN” will select the inboard pylons.
3. Press the Selective Jettison Button

Note: To jettison everything at once, press the Emergency Jettison Pushbutton.



RADIO OVERVIEW

C-101CC	C-101EB
AN/AIC-18 Audio Control System	AN/AIC-18 Audio Control System
VHF-20B VHF Radio <ul style="list-style-type: none"> • 116.000 to 151.975 	AN/ARC-134 VHF Radio <ul style="list-style-type: none"> • 116.000 – 149.975 MHz
V/TVU-740 V/UHF Radio <ul style="list-style-type: none"> • 118.00 to 149.975 MHz • 225.000 to 399.975 MHz 	AN/ARC-164(V) UHF Radio <ul style="list-style-type: none"> • 225.000 – 339.975 MHz
Interphone System	Interphone System

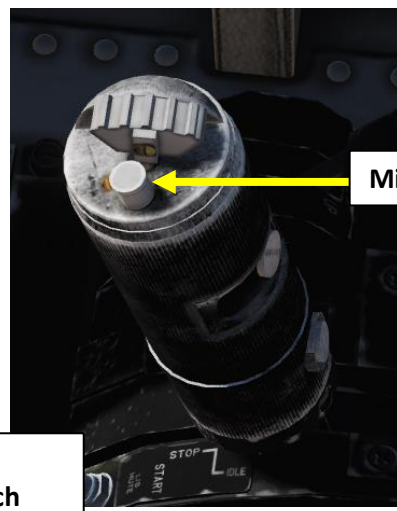


C-101CC Radio Equipment (V/UHF)

To communicate on the V/TVU-740 V/UHF Radio:

1. In the mission editor, you can manually set each preset channel to a certain frequency.
2. Set Intercom Mode Selector to V/U
3. Set Radio Function Selector to A3
4. Set Radio Mode to either M (Manual) or P (Preset)
5. If using a preset channel, use Preset Selector to set desired channel. If using a manual channel, tune frequency manually using the Manual Frequency Selectors.
6. Use microphone switch (on throttle) to communicate on set frequency (Communication Menu = "\ " binding).

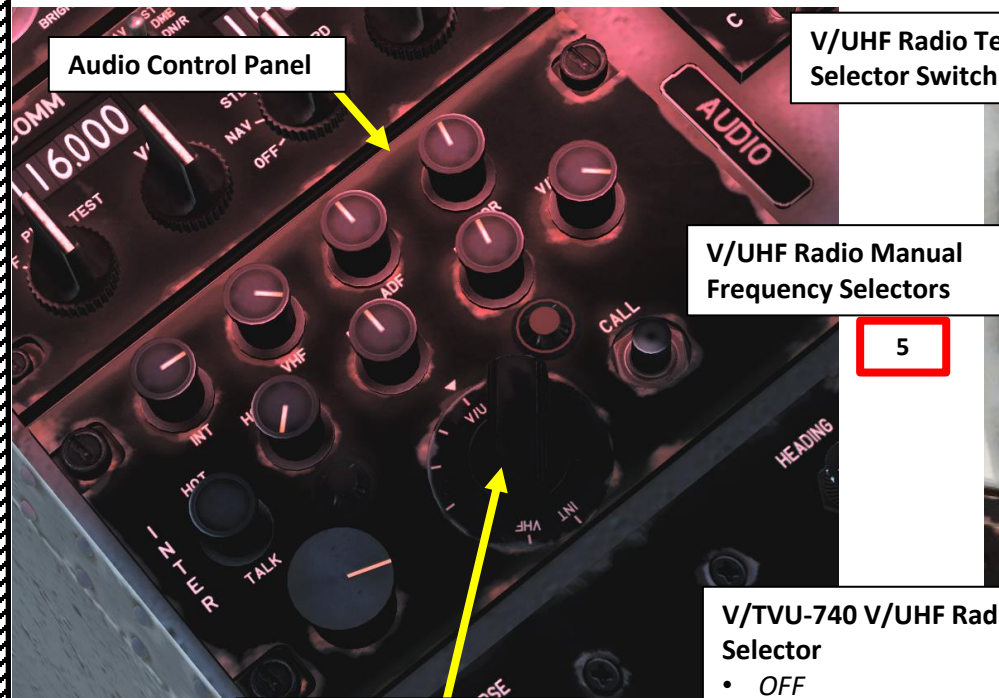
C-101CC	
AN/AIC-18 Audio Control System	
VHF-20B VHF Radio	
<ul style="list-style-type: none"> • 116.000 to 151.975 	
V/TVU-740 V/UHF Radio	
<ul style="list-style-type: none"> • 118.00 to 149.975 MHz • 225.000 to 399.975 MHz 	
Interphone System	



6

Microphone Push-to-Talk Switch

Action	Category	Keyboard
Communication menu	Communications	\

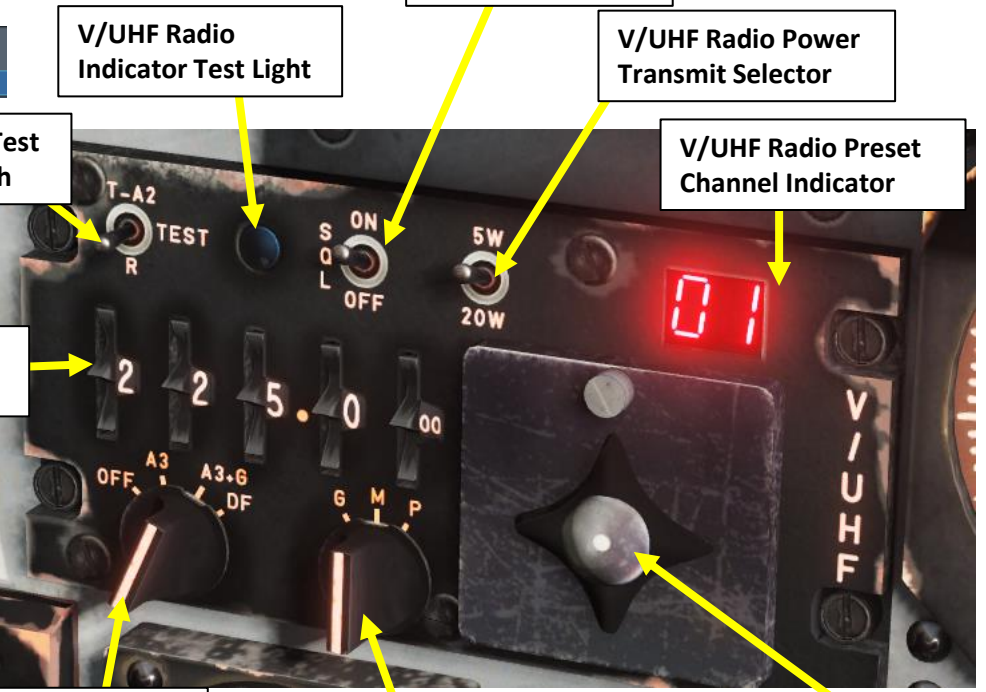


Audio Control Panel

V/UHF Radio Test Selector Switch

V/UHF Radio Manual Frequency Selectors

5



V/UHF Radio Indicator Test Light

V/UHF Radio Squelch Switch

V/UHF Radio Power Transmit Selector

V/UHF Radio Preset Channel Indicator

V/TVU-740 V/UHF Radio Function Selector

- OFF
- A3: Transmit-Receive
- A3+G: Transmit-Receive + Guard
- DF: Directional Finding

3

V/TVU-740 V/UHF Radio Mode Selector

- G: Guard Frequency
- M: Manual Frequency
- P: Preset Frequency

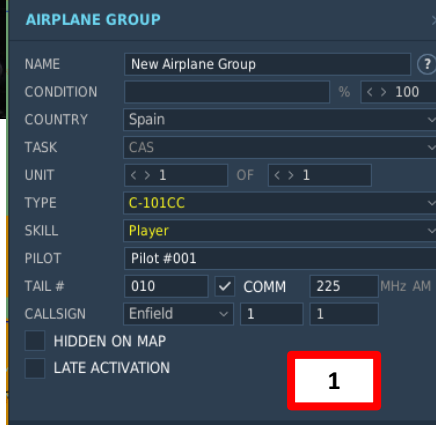
4

V/UHF Radio Preset Channel Selector

5

2

Intercom Mode (Biscuit) Selector Switch
V/UHF, VHF, Intercom



1

V/TVU-740 RADIO PRESETS

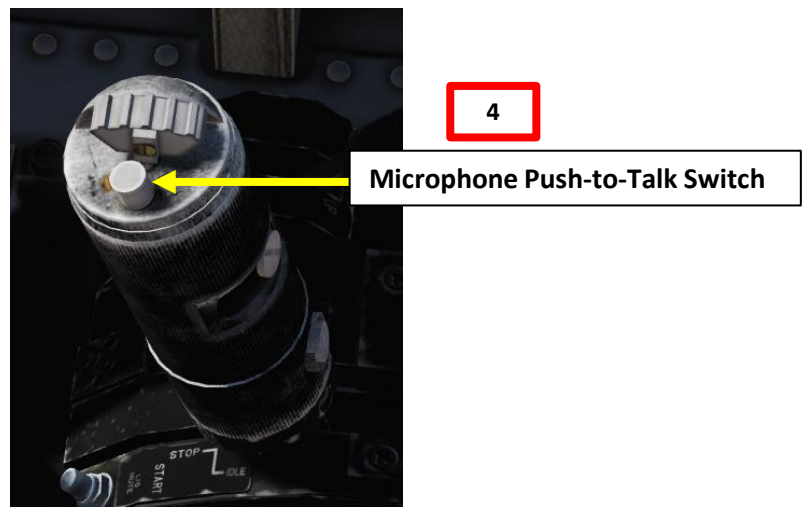
Channel 1	< >	225	MHz	AM
Channel 2	< >	258	MHz	AM
Channel 3	< >	260	MHz	AM
Channel 4	< >	270	MHz	AM
Channel 5	< >	255	MHz	AM
Channel 6	< >	259	MHz	AM
Channel 7	< >	262	MHz	AM
Channel 8	< >	257	MHz	AM
Channel 9	< >	253	MHz	AM
Channel 10	< >	263	MHz	AM
Channel 11	< >	267	MHz	AM
Channel 12	< >	254	MHz	AM
Channel 13	< >	264	MHz	AM
Channel 14	< >	266	MHz	AM
Channel 15	< >	265	MHz	AM
Channel 16	< >	252	MHz	AM
Channel 17	< >	268	MHz	AM
Channel 18	< >	271	MHz	AM
Channel 19	< >	275	MHz	AM
Channel 20	< >	281	MHz	AM
Channel 21	< >	285	MHz	AM

C-101CC Radio Equipment (VHF)

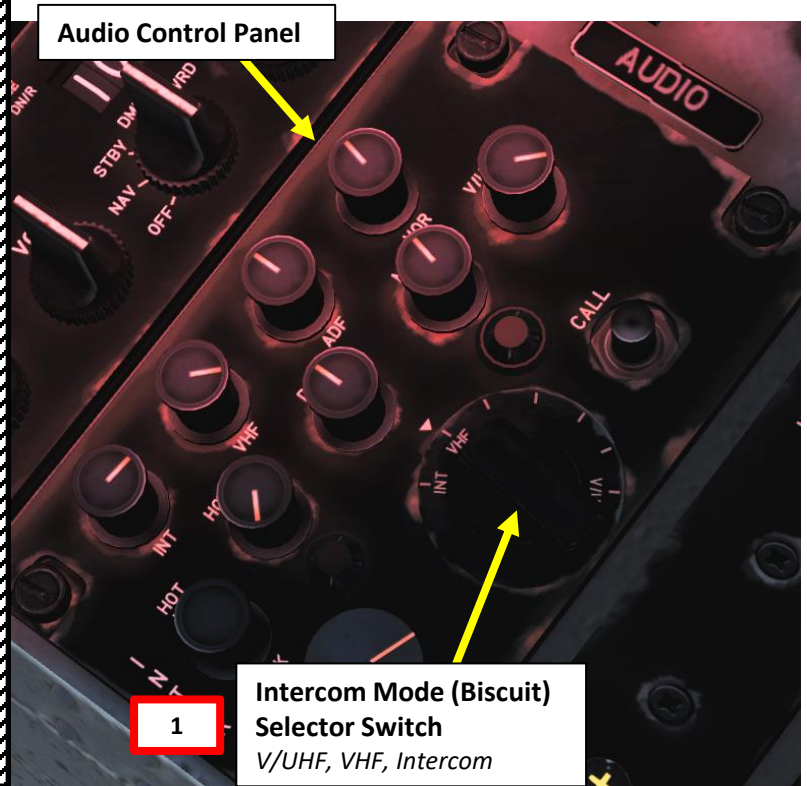
To communicate on the VHF-20B VHF Radio:

1. Set Intercom Mode Selector to VHF
2. Set Radio Mode Control to POWER (Click mouse button).
3. Tune frequency manually by scrolling mousewheel on both VHF Radio Frequency Setting knobs
4. Use microphone switch (on throttle) to communicate on set frequency (Communication Menu = “\” binding).

C-101CC	
AN/AIC-18 Audio Control System	
VHF-20B VHF Radio	<ul style="list-style-type: none"> • 116.000 to 151.975
V/TVU-740 V/UHF Radio	<ul style="list-style-type: none"> • 118.00 to 149.975 MHz • 225.000 to 399.975 MHz
Interphone System	



Action	Category	Keyboard
Communication menu	Communications	\



C-101EB Radio Equipment (UHF & VHF)

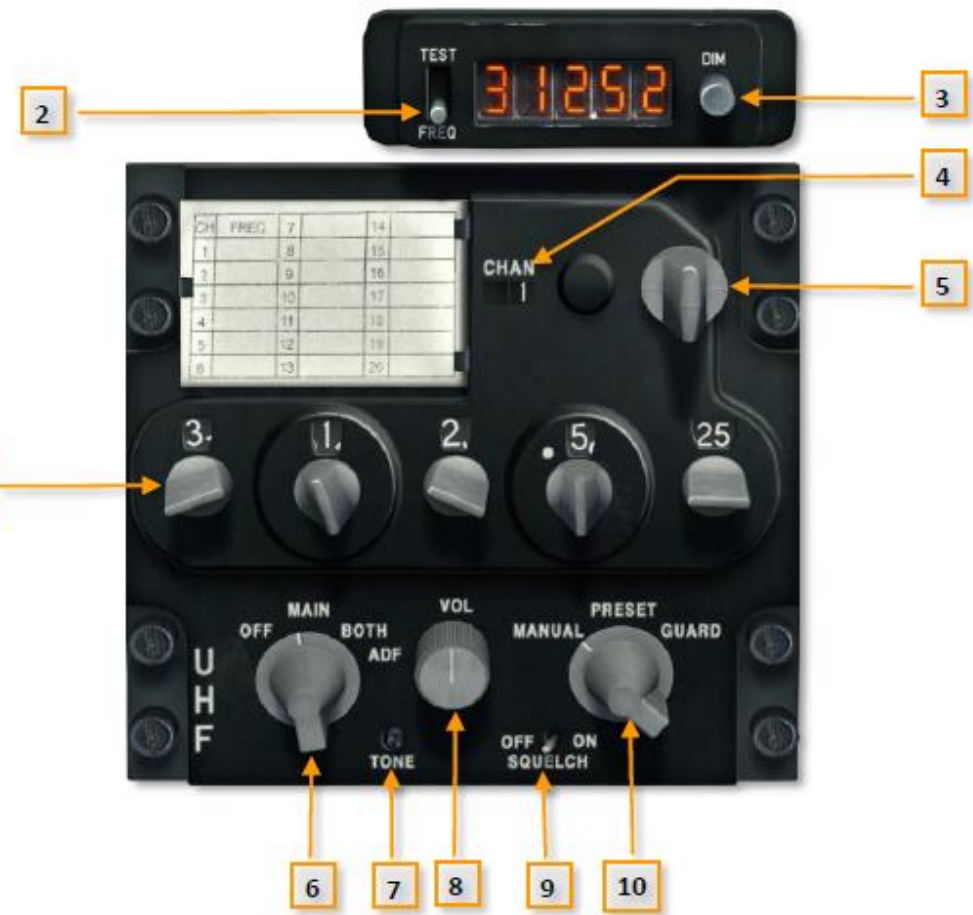
To communicate on the AN/ARC-134 VHF Radio or on the AN/ARC-164(V) UHF Radio, you can pretty much use the same methods described for the C-101CC VHF and V/UHF radio tutorials.

C-101EB	
AN/AIC-18 Audio Control System	
AN/ARC-134 VHF Radio	
• 116.000 – 149.975 MHz	
AN/ARC-164(V) UHF Radio	
• 225.000 – 339.975 MHz	
Interphone System	



AN/ARC-134 VHF Radio Control Panel

- 1 POWER SWITCH
- 2 DIGITS TEST
- 3 FREQUENCY SELECTOR (10 MHz INCREMENTS)
- 4 FREQUENCY SELECTOR (1 MHz INCREMENTS)
- 5 FREQUENCY SELECTOR (0.1 MHz INCREMENTS)
- 6 FREQUENCY SELECTOR (25 kHz INCREMENTS)
- 7 DIMMER/VOLUME KNOB



AN/ARC-164(V) UHF Radio Control Panel

- 1 FREQUENCY SELECTORS
- 2 INDICATION MODE AND TEST SELECTOR
- 3 DIMMER
- 4 PRESET CHANNEL INDICATOR
- 5 PRESET CHANNEL SELECTOR
- 6 FUNCTION SELECTOR
- 7 TONE TEST BUTTON
- 8 VOLUME KNOB
- 9 SQUELCH
- 10 MODE SELECTOR

FLIGHT DIRECTOR – INTRODUCTION

The Flight Director (FD) system provides attitude and radio navigation information integrated in the ADI and HSI. The system comprises the following components located in the cockpit:

- Attitude Director Indicator (ADI)
- Horizontal Situation Indicator (HSI)
- Flight Director Computer
- Flight Director Annunciator
- HSI Remote Control
- Altitude Control

The Flight Director is not an autopilot: it merely gives you a visual reference on the ADI to “direct” you in the desired attitude, speed or direction selected with the Mode Selectors. Some FD modes can be combined together, and the Flight Director bars will take all of the selected modes into account when giving you directions.

Flight Director Mode Selectors (C-101CC)				
HDG: Heading Mode	NAV: Navigation Mode	APR: Approach Mode	BC: Back Course Mode	VOR APR: VOR Approach Mode
ALT: Altitude Mode	GA: Go Around Mode (Shown on ADI)	VS: Vertical Speed Hold Mode	IAS: Indicated Airspeed Mode	SBY: Standby Mode



FLIGHT DIRECTOR – C-101CC MODES

- 1 GO-AROUND MODE ANNUNCIATOR
- 2 SPEED COMMAND POINTER
- 3 RISING RUNWAY
- 4 DECISION HEIGHT DISPLAY
- 5 RATE OF TURN WARNING FLAG
- 6 RADIO ALTITUDE TEST SWITCH
- 7 ATTITUDE TEST SWITCH

- 8 DECISION HEIGHT SET KNOB AND DIM CONTROL
- 9 RATE OF TURN POINTER
- 10 RADIO ALTITUDE DISPLAY
- 11 LOCALIZER WARNING FLAG
- 12 GLIDE SLOPE WARNING FLAG
- 13 DH ANNUNCIATOR

Attitude Director Indicator (ADI)

Flight Director Mode Selectors (C-101CC)

HDG:
Heading Mode. The heading mode is selected by pressing the HDG push-button. It holds the heading selected in the HSI with the heading selector knob. It can be used in conjunction with the ALT mode.

NAV:
Navigation Mode. This mode is used to intercept and follow a VOR radial (navigate towards or from a VOR station). This can be also called VOR mode. It can also be used to make a LOC (localizer) approach, when the GS (glide slope) signal has failed or is simply missing.

APR:
Approach Mode. This mode is used to make an ILS (Instrument Landing System) approach, that is, full ILS with both LOC (Localizer) and GS (Glide Slope) signals operative. If the GS signal is inexistent or inoperative, you can make a LOC approach and use then the NAV mode of the Flight Director.

VOR APR:
VOR Approach Mode. This mode is used to perform a VOR approach. A VOR approach is a type of non-precision approach that can be used in IFR conditions at certain airports when, for example, there is no ILS available. The mode operates in an identical way to the VOR mode (NAV mode) but with optimized gain, which provides more precision for the VOR approach.

ALT:
Altitude Mode. The altitude hold mode is selected by pressing the ALT push-button. It commands the remote pitch to maintain barometric altitude. It should be connected with wings level, and can be used in conjunction with HDG mode before glide slope capture.

GA:
Go Around Mode (annunciator shown on ADI). The go-around mode is selected by pressing the remote go-around switch, which is the front cockpit control stick GA switch. The horizontal command bar receives a fixed pitch-up attitude command. Once go-around is selected, any roll mode can be selected and will cancel the wings-level roll command. The go-around mode is cancelled by selecting another pitch mode or TCS.

VS:
Vertical Speed Hold Mode. The vertical speed hold mode is selected by pressing the VS button on the Mode Selector. It overrides the APR CAP, GA, ALT, IAS or pitch hold modes. In the VS mode, pitch command is proportional to VS error provided by the air data computer. Pressing and holding the TCS button on the stick allows the pilot to maneuver the aircraft to a new vertical speed hold reference without disengaging the mode.

IAS:
Indicated Airspeed Mode. The indicated airspeed hold mode is selected by pressing the IAS button on the Mode Selector. It overrides the APR CAP, GA, ALT, VS or pitch hold modes. In the IAS mode, pitch command is proportional to airspeed error provided by the air data computer. Pressing and holding the TCS button on the stick allows the pilot to maneuver the aircraft to a new airspeed hold reference without disengaging the mode.

BC:
Back Course Mode. This mode is used when making a BC approach. A BC approach is a type of non-precision approach that uses the back beam of the ILS localizer signal. For example, when there is no ILS for one of the runway directions, you can use this type of approach since all ILS localizer antenna array radiate not only the frontal beam, but a back beam also, but with lower intensity and lower precision.

SBY:
Standby Mode. The standby mode is selected by pressing the SBY push-button on the Mode Selector located in the front cockpit. This resets all the other flight director modes and biases the command bars from view



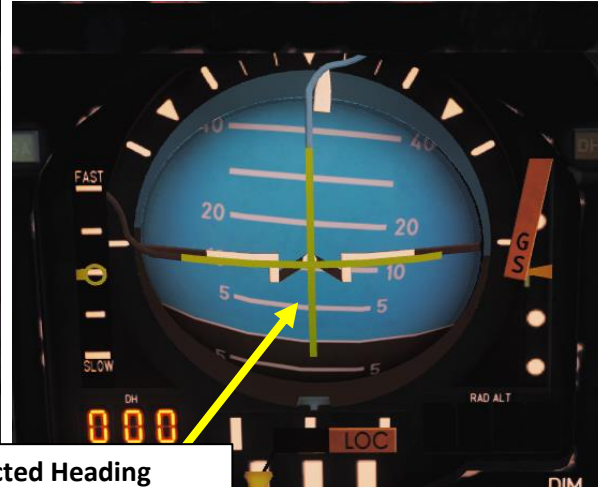
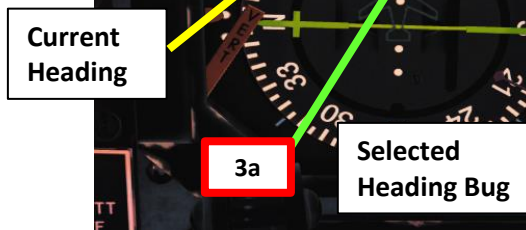
Figure 9-24 Attitude Director Indicator



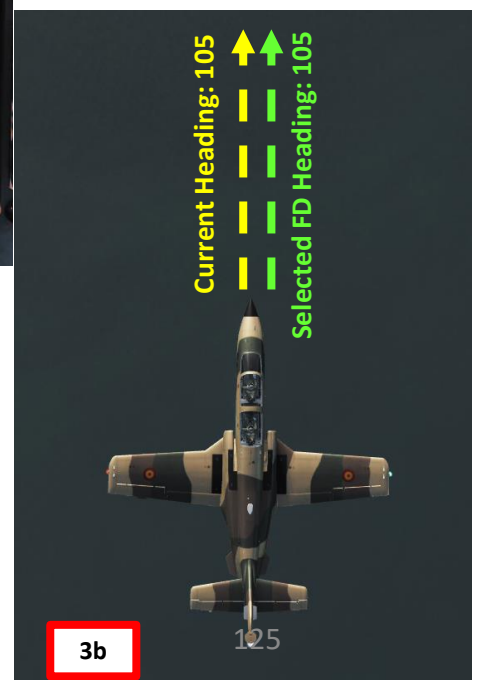
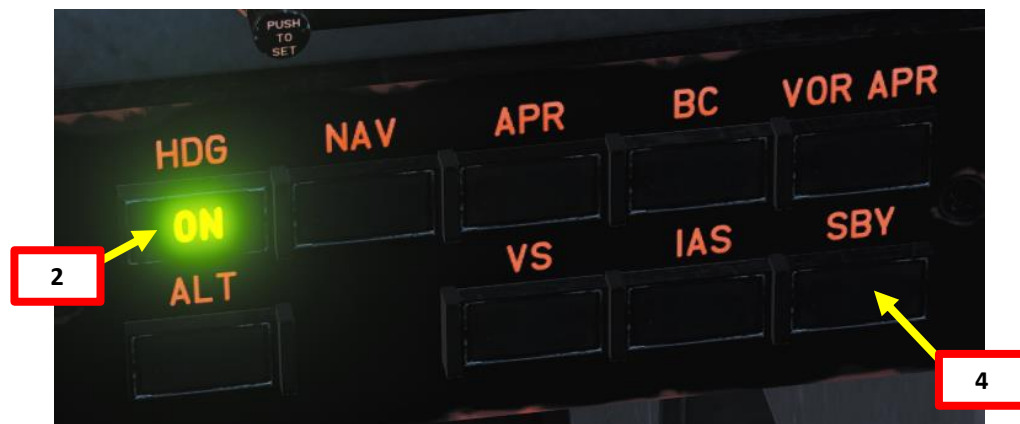
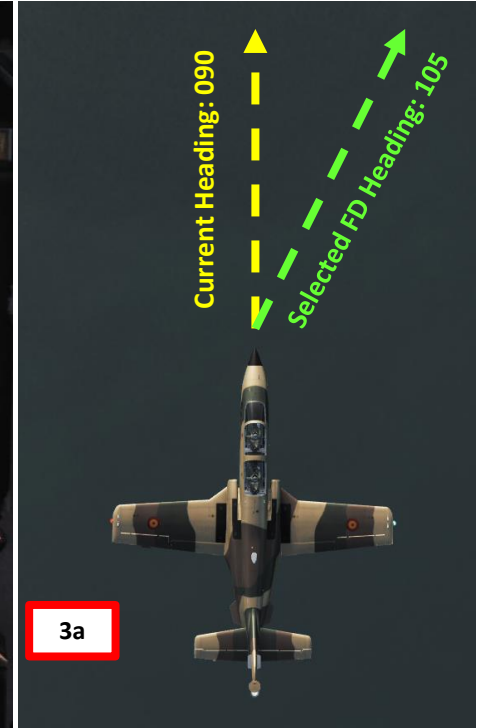
FLIGHT DIRECTOR – C-101CC

HEADING MODE TUTORIAL

1. Select the desired flight director heading to be used as a reference with the HSI Heading Bug Remote Control.
2. Press the HDG Flight Director Mode Button
3. Steer the aircraft to align center of your ADI with the vertical FD bar. Turn the aircraft towards the FD bar to steer towards the selected heading reference.
4. Press the SBY (Standby) FD Mode Button to disengage flight director.



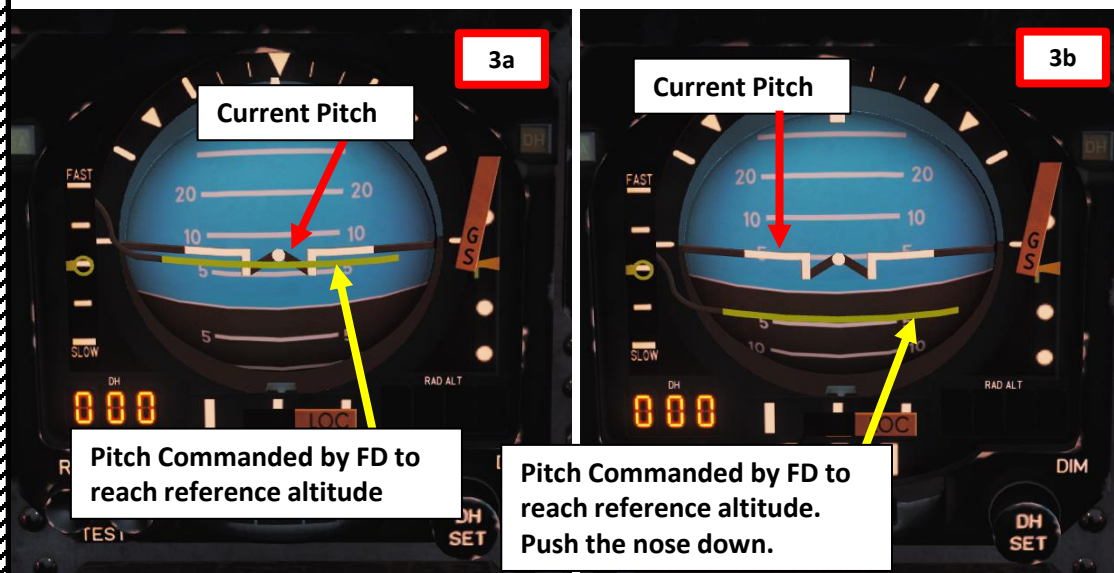
3b



FLIGHT DIRECTOR – C-101CC

ALTITUDE HOLD MODE TUTORIAL

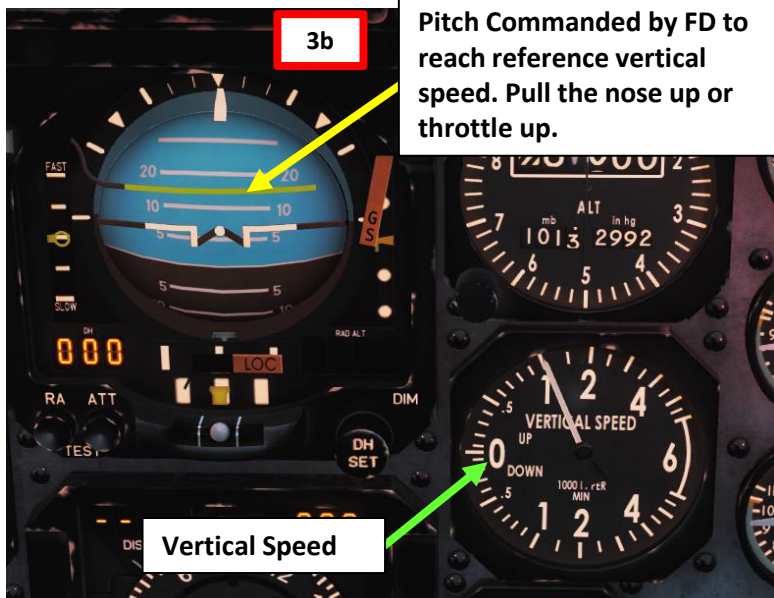
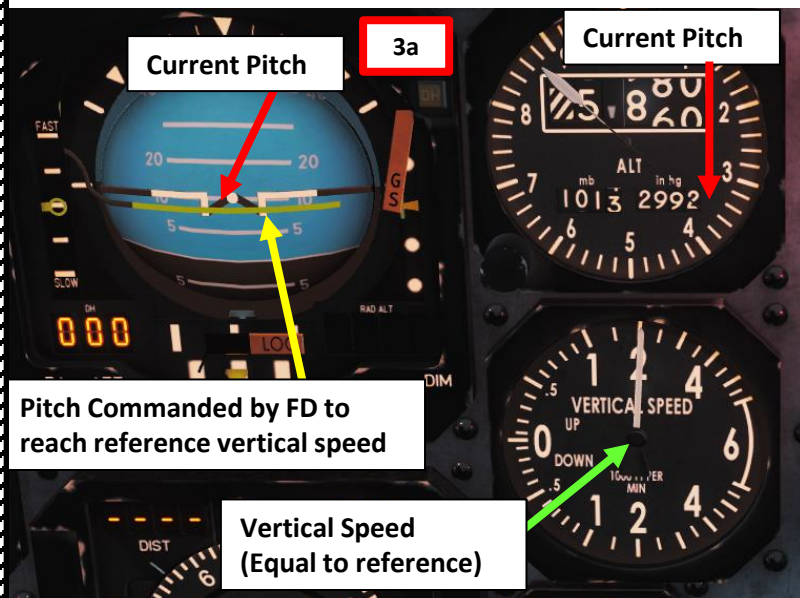
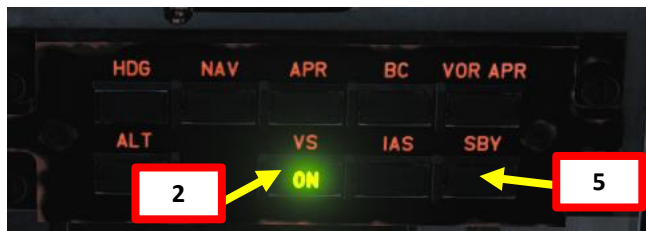
1. Fly to the desired altitude you want to maintain
2. Press the ALT Flight Director Mode Button to record your current altitude as the reference altitude of the flight director
3. Use throttle and/or stick to control your altitude in order to align aircraft pitch on your ADI with the horizontal FD bar. As you deviate from the reference altitude, follow the FD bar to go back to reference altitude.
4. If you want to change your reference altitude, you can press the TCS (Touch Control Steering) button to set your current altitude as the new reference altitude (FD bar will move to center).
5. Press the SBY (Standby) FD Mode Button to disengage flight director.



FLIGHT DIRECTOR – C-101CC

VERTICAL SPEED HOLD MODE TUTORIAL

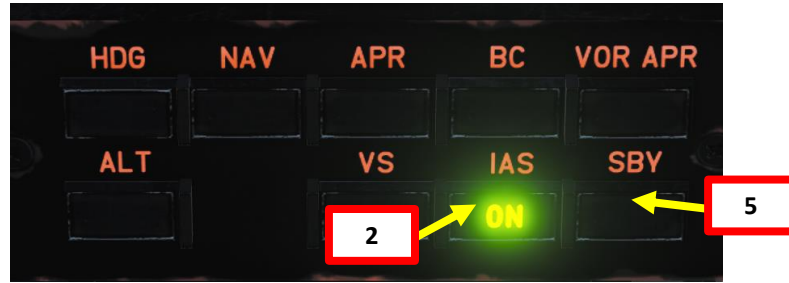
1. Fly to maintain desired vertical speed
2. Press the VS Flight Director Mode Button to record your current vertical speed as the reference vertical speed of the flight director
3. Use throttle and/or stick to control your vertical speed in order to align aircraft pitch on your ADI with the horizontal FD bar. As you deviate from the reference vertical speed, follow the FD bar to go back to reference altitude.
4. If you want to change your reference vertical speed, you can press the TCS (Touch Control Steering) button to set your current vertical speed as the new reference vertical speed (FD bar will move to center).
5. Press the SBY (Standby) FD Mode Button to disengage flight director.



FLIGHT DIRECTOR – C-101CC

IAS HOLD MODE TUTORIAL

1. Fly to maintain desired speed
2. Press the IAS Flight Director Mode Button to record your current speed as the reference speed of the flight director
3. Use throttle and/or stick to control your speed in order to align aircraft pitch on your ADI with the horizontal FD bar. As you deviate from the reference speed, follow the FD bar to go back to reference altitude.
4. If you want to change your reference speed, you can press the TCS (Touch Control Steering) button to set your current vertical speed as the new reference speed (FD bar will move to center).
5. Press the SBY (Standby) FD Mode Button to disengage flight director.



Pitch Commanded by FD to reach reference speed. We are going 20 kts above reference speed: pull the nose up or throttle down to reduce airspeed.



4

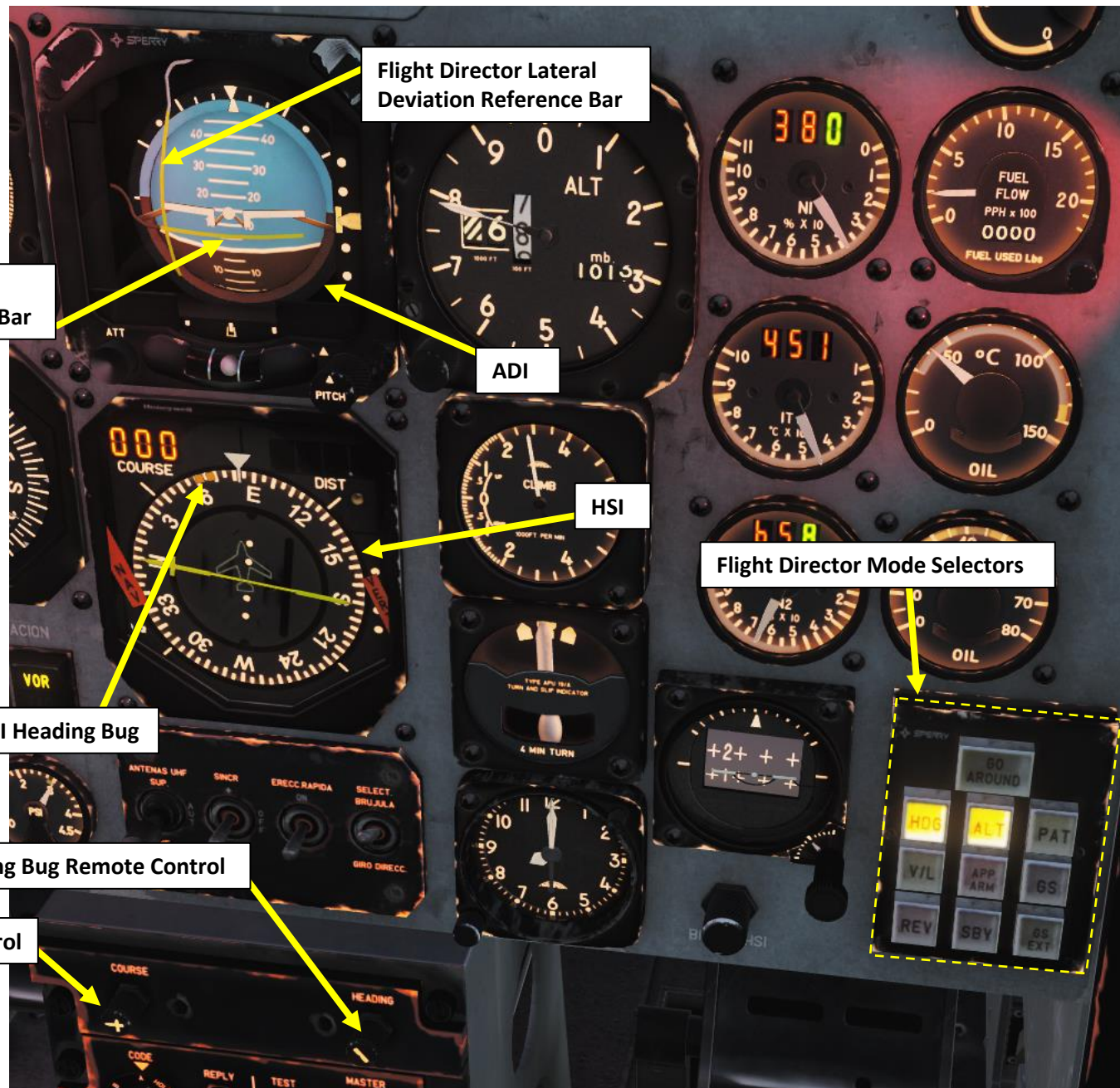
Flight Director TCS (Touch Control Steering) Button

FLIGHT DIRECTOR – C-101EB

The Flight Director (FD) on the C-101EB works very similarly to the C-101CC's. Some FD modes are different between both aircraft.

Flight Director Mode Selectors (C-101EB)

	GO AROUND: Go Around Mode	
HDG: Heading Mode	ALT: Altitude Mode	PAT: Pitch Attitude Trim Mode
V/L: VOR or Localizer Mode	APP ARM: Approach Arm Mode	GS: Glide Slope Mode
REV: Reverse Localizer Mode	SBY: Standby Mode	GS EXT: Glide Slope Extended Mode



Flight Director Lateral Deviation Reference Bar

Flight Director Pitch Deviation Reference Bar

ADI

HSI

Flight Director Mode Selectors

HSI Heading Bug

HSI Heading Bug Remote Control

HSI Course Select Remote Control

FLIGHT DIRECTOR – C-101EB MODES

Flight Director Mode Selectors (C-101EB)

	<p>GO AROUND: <u>Go Around Mode.</u> Go Around Mode. The go around mode is selected by pressing the GO AROUND push-button. When pressed, the horizontal bar will show optimum climb angle and the vertical bar wings level. When a lateral mode is selected afterwards, the vertical bar will show that mode and the horizontal bar will remain in the go around mode.</p>	
<p>HDG: <u>Heading Mode.</u> The heading mode is selected by pressing the HDG push-button. It holds the heading selected in the HSI with the heading selector knob. It can be used in conjunction with the PAT or ALT modes.</p>	<p>ALT: <u>Altitude Mode.</u> The altitude hold mode is selected by pressing the ALT push-button. It commands the required pitch to maintain barometric altitude. It should be connected with wings level, and can be used in conjunction with HDG and V/L modes before glide slope capture.</p>	<p>PAT: <u>Pitch Attitude Trim Mode.</u> The pitch attitude trim mode is selected by pressing the PAT push-button. The FD horizontal bar will hold the pitch set with the ADI pitch adjustment knob in the front cockpit.</p>
<p>V/L: <u>VOR or Localizer Mode.</u> The VOR or LOC mode is selected by pressing the V/L push-button. When selected, the FD will keep heading until intercept and capture of the selected VOR radial or LOC.</p>	<p>APP ARM: <u>Approach Arm Mode.</u> The approach arm mode is selected by pressing the APP ARM push-button. When selected, the system stays ready for GS and LOC capture. V/L and GS will illuminate when the LOC and GS are captured. It can be used in combination with HDG mode.</p>	<p>GS: <u>Glide Slope Mode.</u> The glide slope mode is selected by pressing the GS push-button. When selected, the system will provide commands for LOC and GS capture. V/L and GS will illuminate provided that there is a valid LOC and/or GS signal.</p>
<p>REV: <u>Reverse Localizer Mode.</u> The reverse localizer mode is selected by pressing the REV push-button. It allows to fly a back course approach and it can be used with both pitch modes, PAT and ALT.</p>	<p>SBY: <u>Standby Mode.</u> The standby mode is selected by pressing the SBY push-button on the Mode Selector located in the front cockpit. This resets all the other flight director modes and biases the command bars from view.</p>	<p>GS EXT: <u>Glide Slope Extended Mode.</u> When following the ILS, after passing the Middle Marker, the computer adjusts automatically its gain to compensate for the narrowing of the glide path beam, changing the flight director system from GS mode to GS EXT (glide path extension) mode and illuminating the GS EXT indicator. The indications of the flight director's bars continue presenting the maneuver to be made in a normalized way.</p>

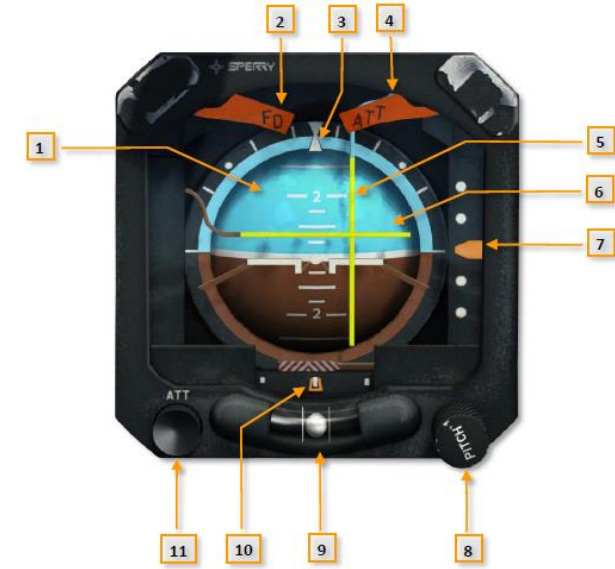


Figure 3-76 ADI

- 1 ATTITUDE SPHERE
- 2 FLIGHT DIRECTOR FAILURE FLAG
- 3 ROLL INDEX
- 4 ATTITUDE FAILURE FLAG
- 5 ROLL COMMAND BAR
- 6 PITCH COMMAND BAR
- 7 GLIDE SLOPE DEVIATION POINTER
- 8 PITCH ADJUSTMENT KNOB
- 9 INCLINOMETER
- 10 LOCALIZER DEVIATION POINTER
- 11 ATTITUDE TEST BUTTON



NAVIGATION EQUIPMENT OVERVIEW

Navigation is an extensive subject. You can check chapter 16 of FAA manual for more details on navigation.

LINK: https://www.faa.gov/sites/faa.gov/files/18_phak_ch16.pdf

“NDB” is what we call a non-directional beacon. It transmits radio waves on a certain frequency on long distances. These waves are read by an ADF (automatic direction finder), which is the ADF system on the C-101CC. NDBs are typically used for radio navigation.

- “VOR” is what we call a VHF Omnidirectional Range system. It transmits radio waves on a certain frequency. These waves are read by a VOR receiver. VOR systems, just like NDBs, can be used for radio navigation.
- NDB and VOR are used just like lighthouses were used to guide ships. This way, air corridors and airways are created to help control an increasingly crowded sky.
- ILS (Instrument Landing System) allows an aircraft find their way to an airstrip (provided it is equipped with a VOR or NDB) despite bad visibility conditions.
- TACAN is a Tactical Air Navigation System used by the military. TACAN beacons can be placed on ground stations, airfields or even aircraft themselves like tankers. The TACAN station equipment on the ground has two parts, one provides bearing and the other one distance. A VOR station on the ground only provides bearing. There are also DME stations on the ground to provide distance. A VOR onboard equipment can receive the distance signal from the TACAN "distance part" of the equipment on ground. And, of course, a VOR onboard equipment can receive also the distance signal from a DME (Distance Measuring Equipment) station.
- The **ADF-60 ADF** (Automatic Direction Finder) system on the C-101CC can help you track NDB stations.
- The **VHF-20B** (C-101CC) and **AN/ARN-127** (C-101EB) systems both track VOR stations.

C-101CC	C-101EB
ADF-60 ADF Equipment <ul style="list-style-type: none"> • 190 – 1749.5 KHz 	AN/ARN-118 TACAN Equipment
VHF-20B NAV (VOR/ILS) Equipment <ul style="list-style-type: none"> • 108.00 – 117.95 MHz 	AN/ARN-127 VOR/ILS/MB <ul style="list-style-type: none"> • 108.00 – 117.95 MHz
Note: The C-101CC doesn't really have a TACAN receiver, but we can tune any TACAN ground station using the VOR receiver, to obtain the distance to the Station. However, this doesn't provide us with a Heading to the Station, only distance. There is a conversion chart available for TACAN/DME channels paired with NAV/VOR frequencies.	

NAVIGATION – MAGNETIC DEVIATION

The direction in which a compass needle points is known as magnetic north. In general, this is not exactly the direction of the North Magnetic Pole (or of any other consistent location). Instead, the compass aligns itself to the local geomagnetic field, which varies in a complex manner over the Earth's surface, as well as over time. The local angular difference between magnetic north and true north is called the magnetic declination. Most **map coordinate** systems are based on **true north**, and magnetic declination is often shown on map legends so that the direction of true north can be determined from north as indicated by a compass.

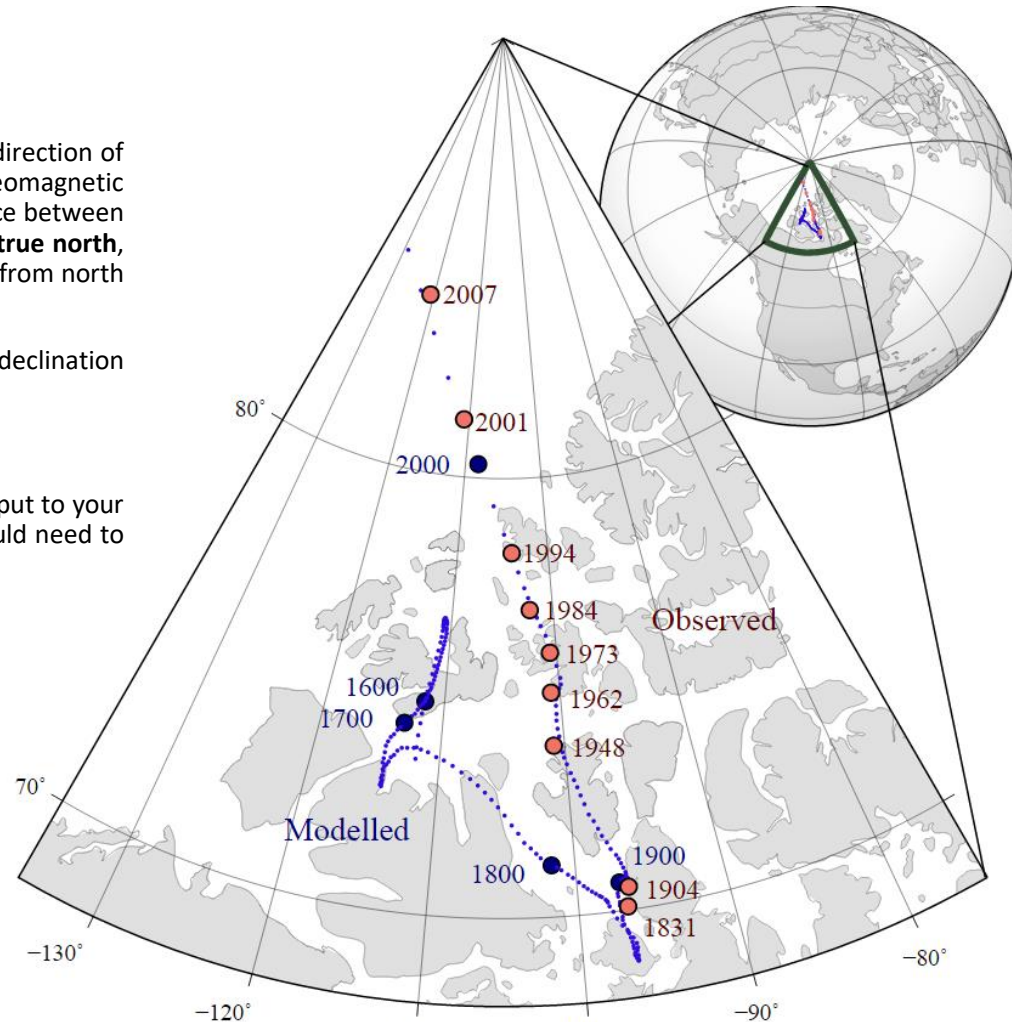
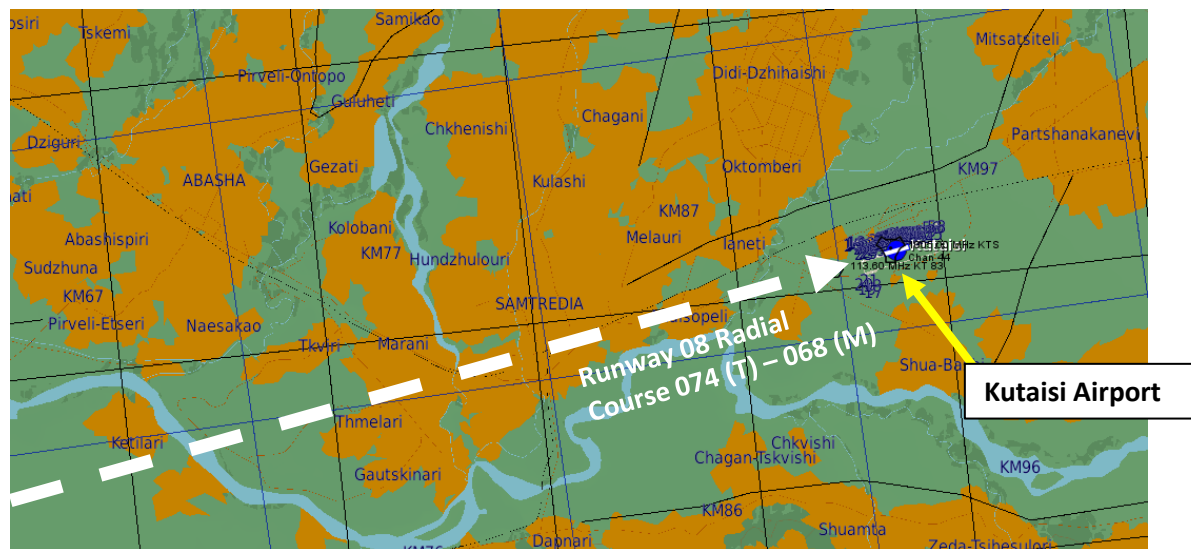
This is the reason why in DCS, the course to a runway needs to be “adjusted” to take into account this magnetic declination of the magnetic North pole (which is actually modelled in the sim, which is pretty neat).

True Heading = Magnetic Heading + Magnetic Deviation

As an example, if the runway heading that you read on the F10 map in Kutaisi is 074 (True Heading), then the input to your magnetic compass course should be 074 subtracted with the Magnetic Deviation (+6 degrees), or 068. You would need to enter a course of 068 (M) on the HSI.

Magnetic Declination:

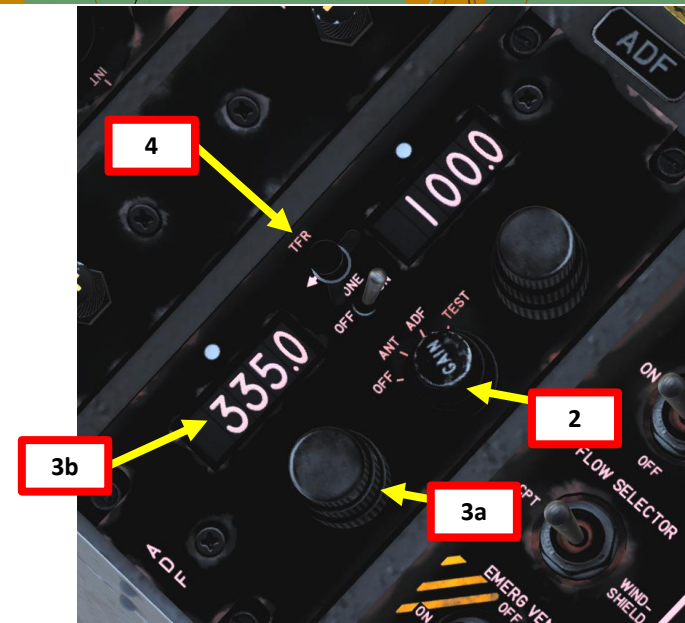
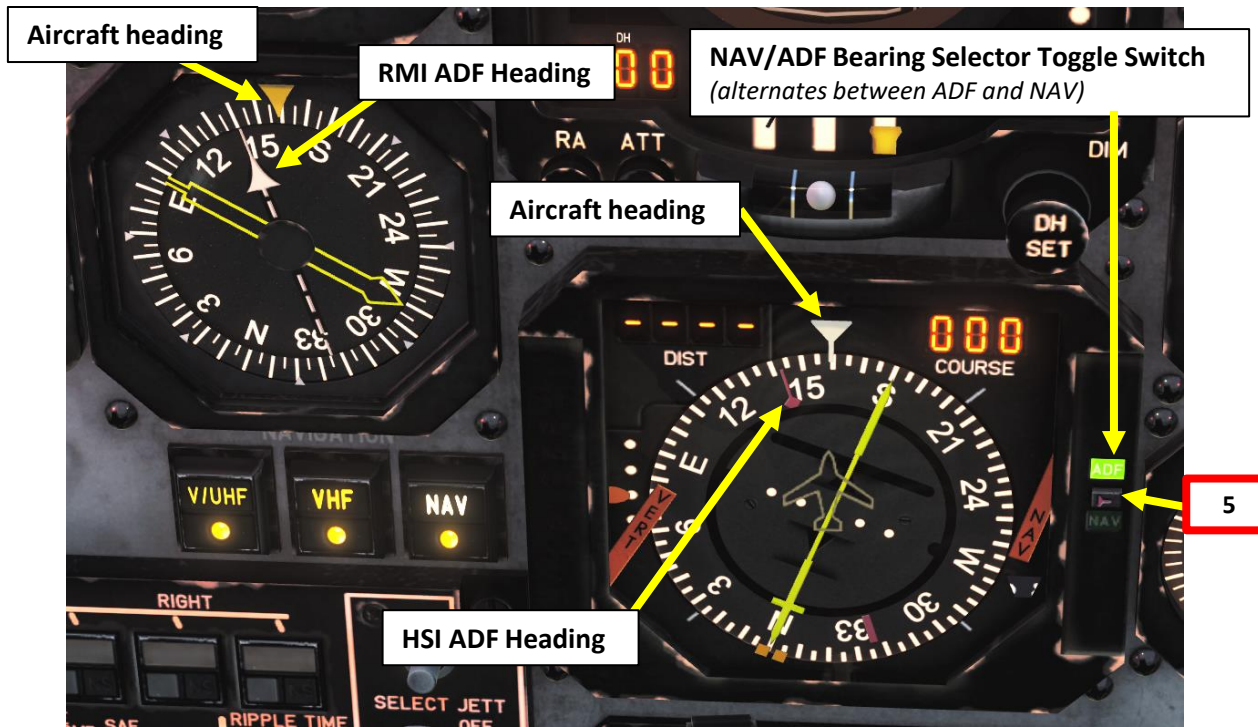
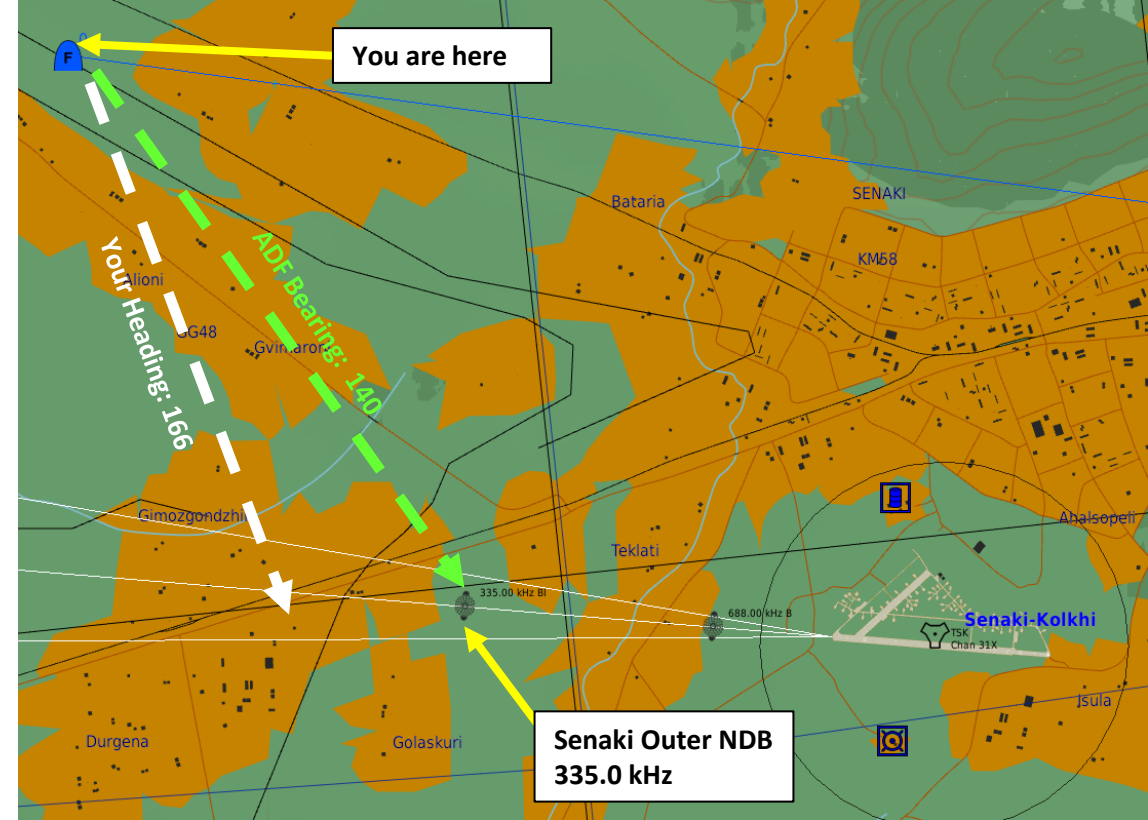
- **Caucasus = approx +6° (East)**
- **Nevada = approx +12° (East)**
- **Normandy = approx +8 ° (East)**
- **Persian Gulf = approx +1.6° (East)**



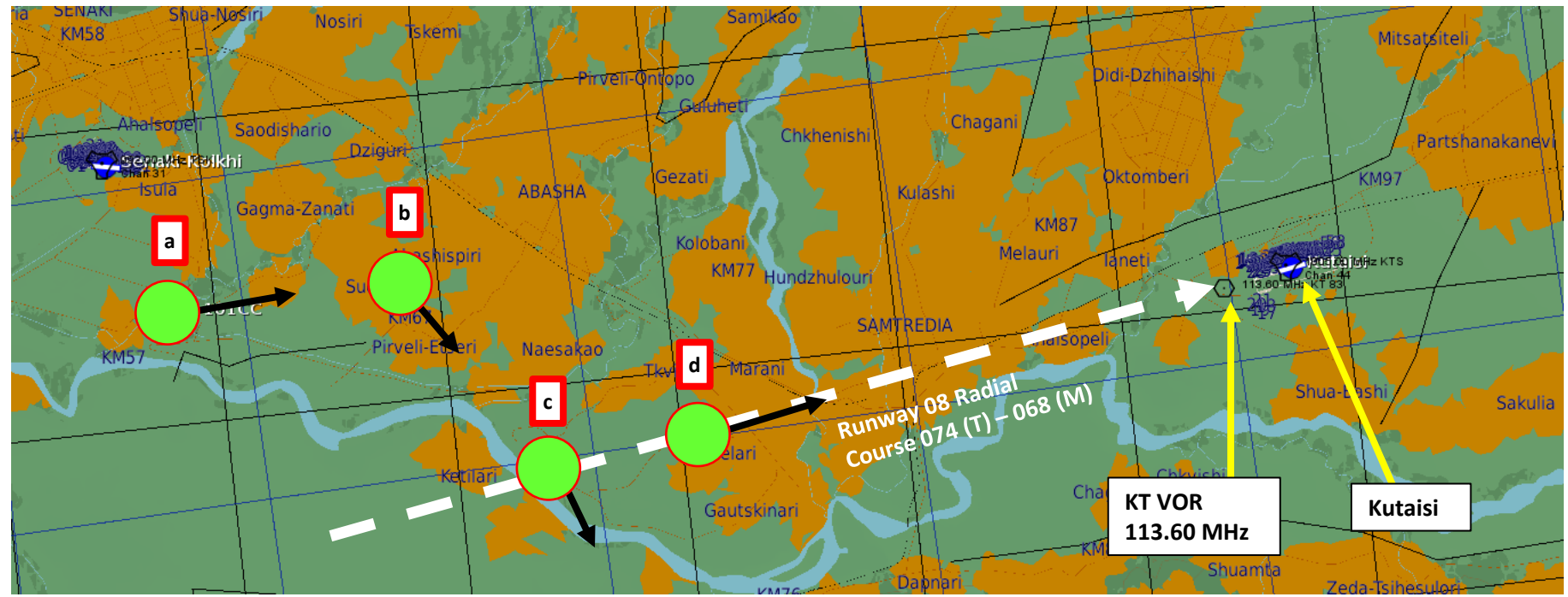
The movement of Earth's north magnetic pole across the Canadian arctic, 1831–2007.

ADF-60 ADF NAVIGATION TUTORIAL (C-101CC)

1. We will track Senaki's outer NDB (335.0 kHz) and get the bearing information from it.
2. Set ADF Mode selector to ADF (click mouse button).
3. Set the ADF's frequency (335.0 kHz) on the ADF panel by using the tuning knob of the left panel visor.
 - Mousewheel scrolling dials the tens
 - Right Click Hold + Mousewheel scrolling dials the units
 - Left Click Hold + Mousewheel scrolling dials the hundreds
4. Set ADF TFR (Transfer) selector to the left panel visor (active station)
5. ADF direction will be shown on the RMI (Radio-Magnetic Indicator) thin white needle.
6. Set HSI (Horizontal Situation Indicator) mode to ADF by pressing the NAV/ADF Bearing Selector button.
7. After a few seconds, the HSI will display the bearing to the ADF with the pointy end of the pink needle.
8. Steer the aircraft to align your current heading triangle with the pointy end of the ADF needle.



VHF-20B VOR NAVIGATION TUTORIAL (C-101CC)



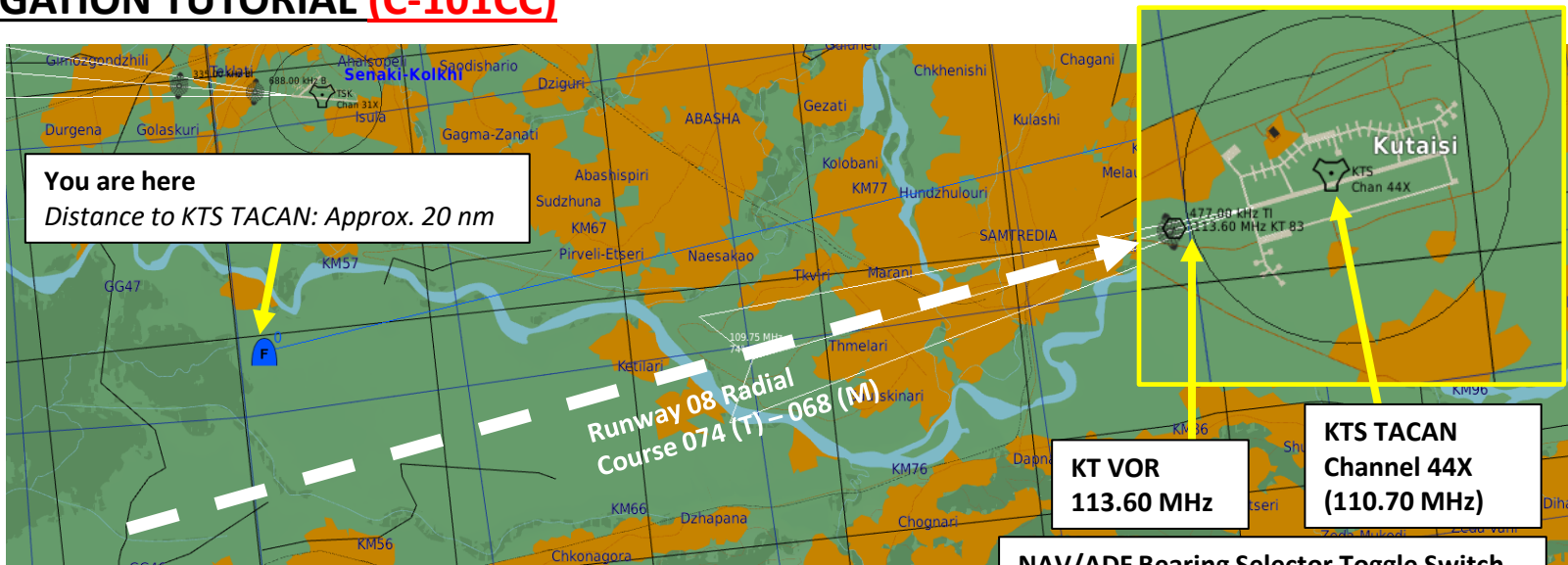
VHF-20B VOR NAVIGATION TUTORIAL (C-101CC)



VHF-20B TACAN (VOR RECEIVER) NAVIGATION TUTORIAL (C-101CC)

The C-101CC doesn't really have a TACAN receiver, but we can tune any TACAN ground station using the VOR receiver, to obtain the distance to the Station. However, this doesn't provide us with a Heading to the Station, only distance. We can then use the "DME HOLD" function to combine the tracked TACAN distance to an actual VOR bearing.

1. We will track Kutaisi's TACAN 44X and get the distance information from it, then track the KT VOR (113.60 MHz) next to it to get a bearing information to Kutaisi.
2. Use the "TACAN/DME Channels and Paired Frequencies" chart on the next page to convert the 44X TACAN frequency into a valid VOR frequency. For 44X, we will use a NAV frequency of 110.70 MHz.
3. Set NAV Mode selector to DME (click mouse button).
4. Set the TACAN's converted VOR frequency (110.70) on the NAV panel by scrolling mousewheel.
5. Set HSI (Horizontal Situation Indicator) mode to NAV by pressing the NAV/ADF Bearing Selector button.
6. After a few seconds, the HSI will display DME (Distance Measuring Equipment) distance to the TACAN in nautical miles on the DIST visor.
7. Verify that the NAV Korry is illuminated: this means the information displayed on your HSI comes from the frequencies and modes set in your cockpit instead of the other one.
8. To keep tracking the TACAN distance, set DME switch to HOLD (UP). This will memorize the TACAN frequency and keep tracking its distance information while allowing us to track another navigation aid to get bearing information.



STATION	TACAN
FREQ. MHz	CHANNEL
110.70	44X



VHF-20B TACAN (VOR RECEIVER) NAVIGATION TUTORIAL (C-101CC)

TACAN/DME CHANNELS AND PAIRED FREQUENCIES

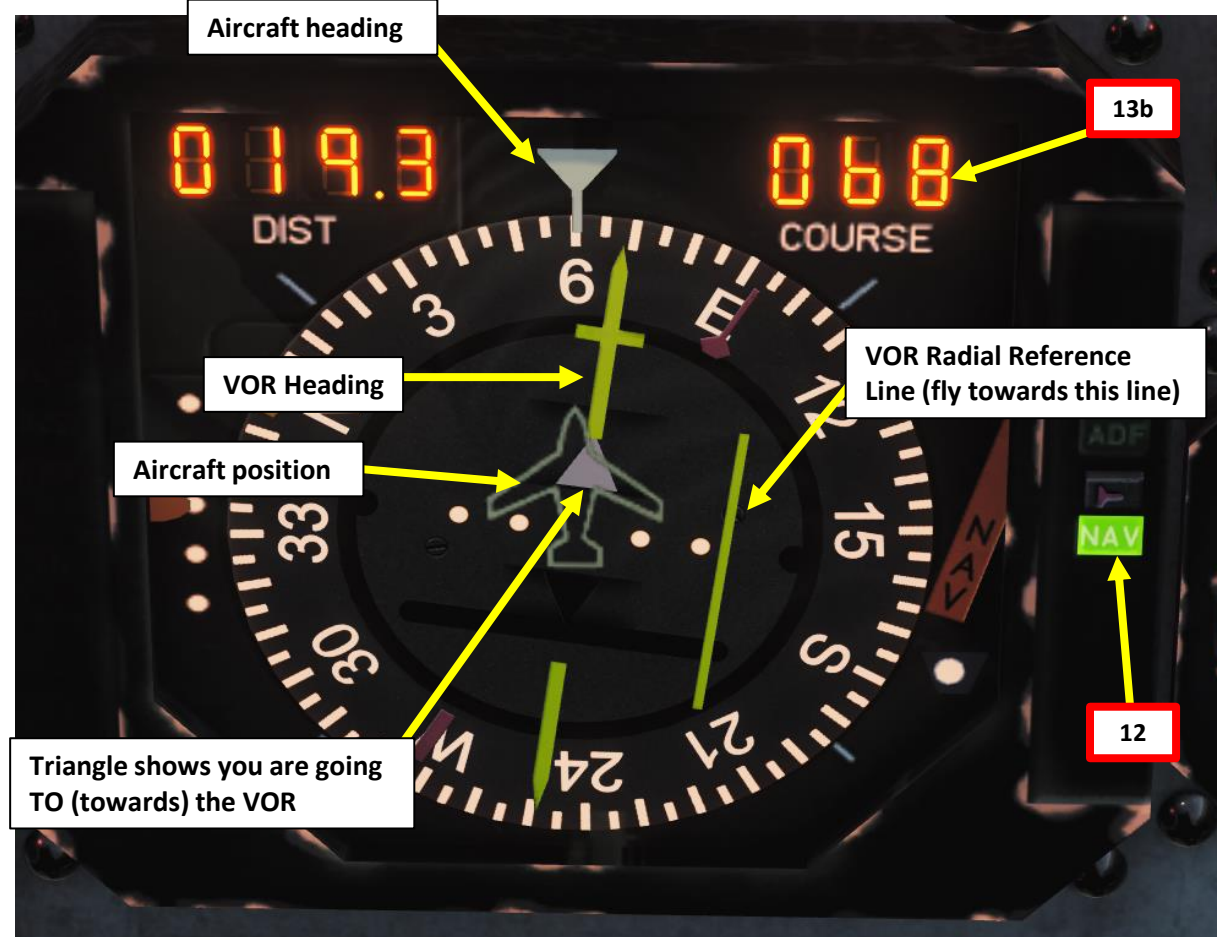
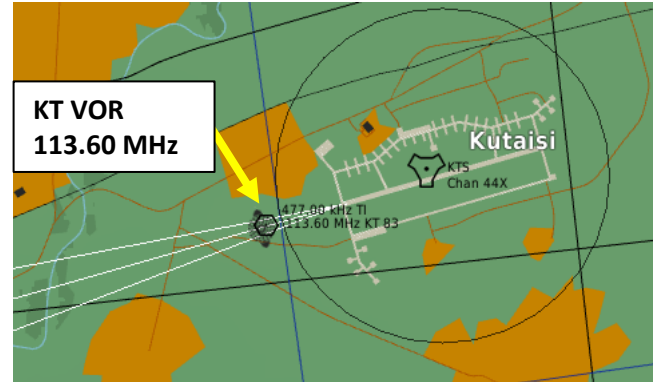
STATION FREQ. MHz	TACAN CHANNEL	INT. FREQ. MHz	REPLY FREQ. MHz	STATION FREQ. MHz	TACAN CHANNEL	INT. FREQ. MHz	REPLY FREQ. MHz
134.40	1X	1025	962	108.55	22Y	1046	1109
134.45	1Y	1025	1088	108.60	23X	1047	984
134.50	2X	1026	963	108.65	23Y	1047	1110
134.55	2Y	1026	1089	108.70	24X	1048	985
134.60	3X	1027	964	108.75	24Y	1048	1111
134.65	3Y	1027	1090	108.80	25X	1049	986
134.70	4X	1028	965	108.85	25Y	1049	1112
134.75	4Y	1028	1091	108.90	26X	1050	987
134.80	5X	1029	966	108.95	26Y	1050	1113
134.85	5Y	1029	1092	109.00	27X	1051	988
134.90	6X	1030	967	109.05	27Y	1051	1114
134.95	6Y	1030	1093	109.10	28X	1052	989
135.00	7X	1031	968	109.15	28Y	1052	1115
135.05	7Y	1031	1094	109.20	29X	1053	990
135.10	8X	1032	969	109.25	29Y	1053	1116
135.15	8Y	1032	1095	109.30	30X	1054	991
135.20	9X	1033	970	109.35	30Y	1054	1117
135.25	9Y	1033	1096	109.40	31X	1055	992
135.30	10X	1034	971	109.45	31Y	1055	1118
135.35	10Y	1034	1097	109.50	32X	1056	993
135.40	11X	1035	972	109.55	32Y	1056	1119
135.45	11Y	1035	1098	109.60	33X	1057	994
135.50	12X	1036	973	109.65	33Y	1057	1120
135.55	12Y	1036	1099	109.70	34X	1058	995
135.60	13X	1037	974	109.75	34Y	1058	1121
135.65	13Y	1037	1100	109.80	35X	1059	996
135.70	14X	1038	975	109.85	35Y	1059	1122
135.75	14Y	1038	1101	109.90	36X	1060	997
135.80	15X	1039	976	109.95	36Y	1060	1123
135.85	15Y	1039	1102	110.00	37X	1061	998
135.90	16X	1040	977	110.05	37Y	1061	1124
135.95	16Y	1040	1103	110.10	38X	1062	999
108.00	17X	1041	978	110.15	38Y	1062	1125
108.05	17Y	1041	1104	110.20	39X	1063	1000
108.10	18X	1042	979	110.25	39Y	1063	1126
108.15	18Y	1042	1105	110.30	40X	1064	1001
108.20	19X	1043	980	110.35	40Y	1064	1127
108.25	19Y	1043	1106	110.40	41X	1065	1002
108.30	20X	1044	981	110.45	41Y	1065	1128
108.35	20Y	1044	1107	110.50	42X	1066	1003
108.40	21X	1045	982	110.55	42Y	1066	1129
108.45	21Y	1045	1108	110.60	43X	1067	1004
108.50	22X	1046	983	110.65	43Y	1067	1130

STATION FREQ. MHz	TACAN CHANNEL	INT. FREQ. MHz	REPLY FREQ. MHz	STATION FREQ. MHz	TACAN CHANNEL	INT. FREQ. MHz	REPLY FREQ. MHz
110.70	44X	1068	1005	134.00	67X	1091	1154
110.75	44Y	1068	1131	134.05	67Y	1091	1028
110.80	45X	1069	1006	134.10	68X	1092	1155
110.85	45Y	1069	1132	134.15	68Y	1092	1029
110.90	46X	1070	1007	134.20	69X	1093	1156
110.95	46Y	1070	1133	134.25	69Y	1093	1030
111.00	47X	1071	1008	112.30	70X	1094	1157
111.05	47Y	1071	1134	112.35	70Y	1094	1031
111.10	48X	1072	1009	112.40	71X	1095	1158
111.15	48Y	1072	1135	112.45	71Y	1095	1032
111.20	49X	1073	1010	112.50	72X	1096	1159
111.25	49Y	1073	1136	112.55	72Y	1096	1033
111.30	50X	1074	1011	112.60	73X	1097	1160
111.35	50Y	1074	1137	112.65	73Y	1097	1034
111.40	51X	1075	1012	112.70	74X	1098	1161
111.45	51Y	1075	1138	112.75	74Y	1098	1035
111.50	52X	1076	1013	112.80	75X	1099	1162
111.55	52Y	1076	1139	112.85	75Y	1099	1036
111.60	53X	1077	1014	112.90	76X	1100	1163
111.65	53Y	1077	1140	112.95	76Y	1100	1037
111.70	54X	1078	1015	113.00	77X	1101	1164
111.75	54Y	1078	1141	113.05	77Y	1101	1038
111.80	55X	1079	1016	113.10	78X	1102	1165
111.85	55Y	1079	1142	113.15	78Y	1102	1039
111.90	56X	1080	1017	113.20	79X	1103	1166
111.95	56Y	1080	1143	113.25	79Y	1103	1040
112.00	57X	1081	1018	113.30	80X	1104	1167
112.05	57Y	1081	1144	113.35	80Y	1104	1041
112.10	58X	1082	1019	113.40	81X	1105	1168
112.15	58Y	1082	1145	113.45	81Y	1105	1042
112.20	59X	1083	1020	113.50	82X	1106	1169
112.25	59Y	1083	1146	113.55	82Y	1106	1043
133.30	60X	1084	1021	113.60	83X	1107	1170
133.35	60Y	1084	1147	113.65	83Y	1107	1044
133.40	61X	1085	1022	113.70	84X	1108	1171
133.45	61Y	1085	1148	113.75	84Y	1108	1045
133.50	62X	1086	1023	113.80	85X	1109	1172
133.55	62Y	1086	1149	113.85	85Y	1109	1046
133.60	63X	1087	1024	113.90	86X	1110	1173
133.65	63Y	1087	1150	113.95	86Y	1110	1047
133.70	64X	1088	1151	114.00	87X	1111	1174
133.75	64Y	1088	1025	114.05	87Y	1111	1048
133.80	65X	1089	1152	114.10	88X	1112	1175
133.85	65Y	1089	1026	114.15	88Y	1112	1049
133.90	66X	1090	1153	114.20	89X	1113	1176
133.95	66Y	1090	1027	114.25	89Y	1113	1050

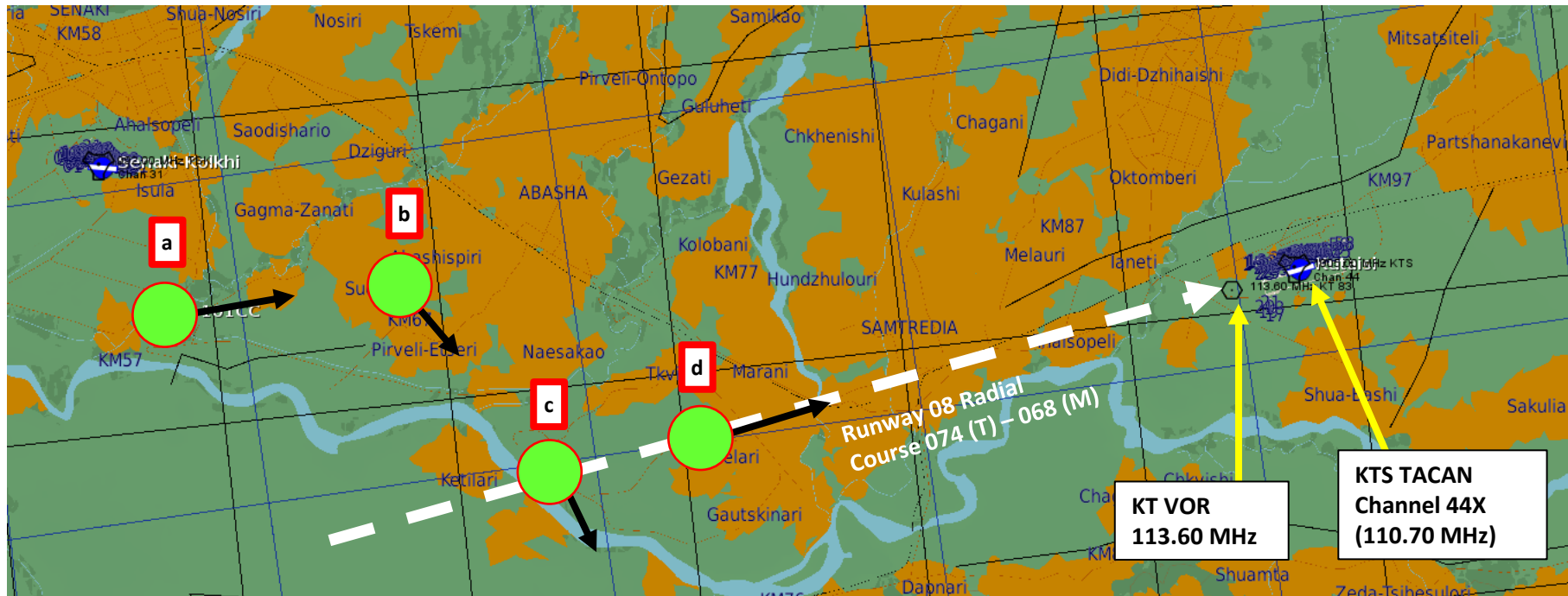
STATION FREQ. MHz	TACAN CHANNEL	INT. FREQ. MHz	REPLY FREQ. MHz	STATION FREQ. MHz	TACAN CHANNEL	INT. FREQ. MHz	REPLY FREQ. MHz
114.30	90X	1114	1177	116.15	108Y	1132	1069
114.35	90Y	1114	1051	116.20	109X	1133	1196
114.40	91X	1115	1178	116.25	109Y	1133	1070
114.45	91Y	1115	1052	116.30	110X	1134	1197
114.50	92X	1116	1179	116.35	110Y	1134	1071
114.55	92Y	1116	1053	116.40	111X	1135	1198
114.60	93X	1117	1180	116.45	111Y	1135	1072
114.65	93Y	1117	1054	116.50	112X	1136	1199
114.70	94X	1118	1181	116.55	112Y	1136	1073
114.75	94Y	1118	1055	116.60	113X	1137	1200
114.80	95X	1119	1182	116.65	113Y	1137	1074
114.85	95Y	1119	1056	116.70	114X	1138	1201
114.90	96X	1120	1183	116.75	114Y	1138	1075
114.95	96Y	1120	1057	116.80	115X	1139	1202
115.00	97X	1121	1184	116.85	115Y	1139	1076
115.05	97Y	1121	1058	116.90	116X	1140	1203
115.10	98X	1122	1185	116.95	116Y	1140	1077
115.15	98Y	1122	1059	117.00	117X	1141	1204
115.20	99X	1123	1186	117.05	117Y	1141	1078
115.25	99Y	1123	1060	117.10	118X	1142	1205
115.30	100X	1124	1187	117.15	118Y	1142	1079
115.35	100Y	1124	1061	117.20	119X	1143	1206
115.40	101X	1125	1188	117.25	119Y	1143	1080
115.45	101Y	1125	1062	117.30	120X	1144	1207
115.50	102X	1126	1189	117.35	120Y	1144	1081
115.55	102Y	1126	1063	117.40	121X	1145	1208
115.60	103X	1127	1190	117.45	121Y	1145	1082
115.65	103Y	1127	1064	117.50	122X	1146	1209
115.70	104X	1128	1191	117.55	122Y	1146	1083
115.75	104Y	1128	1065	117.60	123X	1147	1210
115.80	105X	1129	1192	117.65	123Y	1147	1084
115.85	105Y	1129	1066	117.70	124X	1148	1211
115.90	106X	1130	1193	117.75	124Y	1148	1085
115.95	106Y	1130	1067	117.80	125X	1149	1212
116.00	107X	1131	1194	117.85	125Y	1149	1086
116.05	107Y	1131	1068	117.90	126X	1150	1213
116.10	108X	1132	1195	117.95	126Y	1150	1087

VHF-20B TACAN (VOR RECEIVER) NAVIGATION TUTORIAL (C-101CC)

9. We will now track the KT VOR (113.60 MHz) next to it to get a bearing information to Kutaisi.
10. Make sure the NAV Mode selector is still set to DME.
11. Set the KT VOR's frequency (113.60) on the NAV panel by scrolling mousewheel
12. Make sure HSI (Horizontal Situation Indicator) mode is still set to NAV by checking the NAV Bearing Light on the HSI.
13. Set the desired course to the VOR using the HSI Course Select Remote Control knob (068)
14. Steer the aircraft towards the VOR Radial Reference Line. As you approach the radial, the line deviation with the centerline of the HSI will gradually diminish.
15. When Reference line is centered, this means you are on the 068 radial.
16. Turn towards the VOR Heading needle to follow the radial to the runway.



VHF-20B TACAN (VOR RECEIVER) NAVIGATION TUTORIAL (C-101CC)

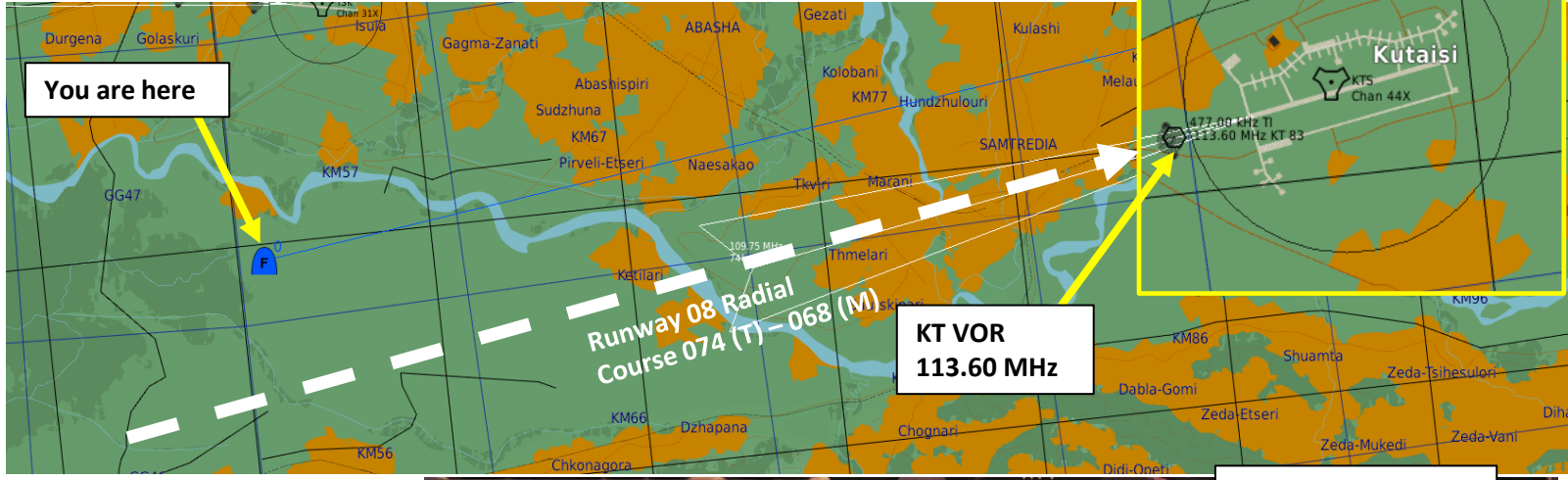


VHF-20B TACAN (VOR RECEIVER) NAVIGATION TUTORIAL (C-101CC)

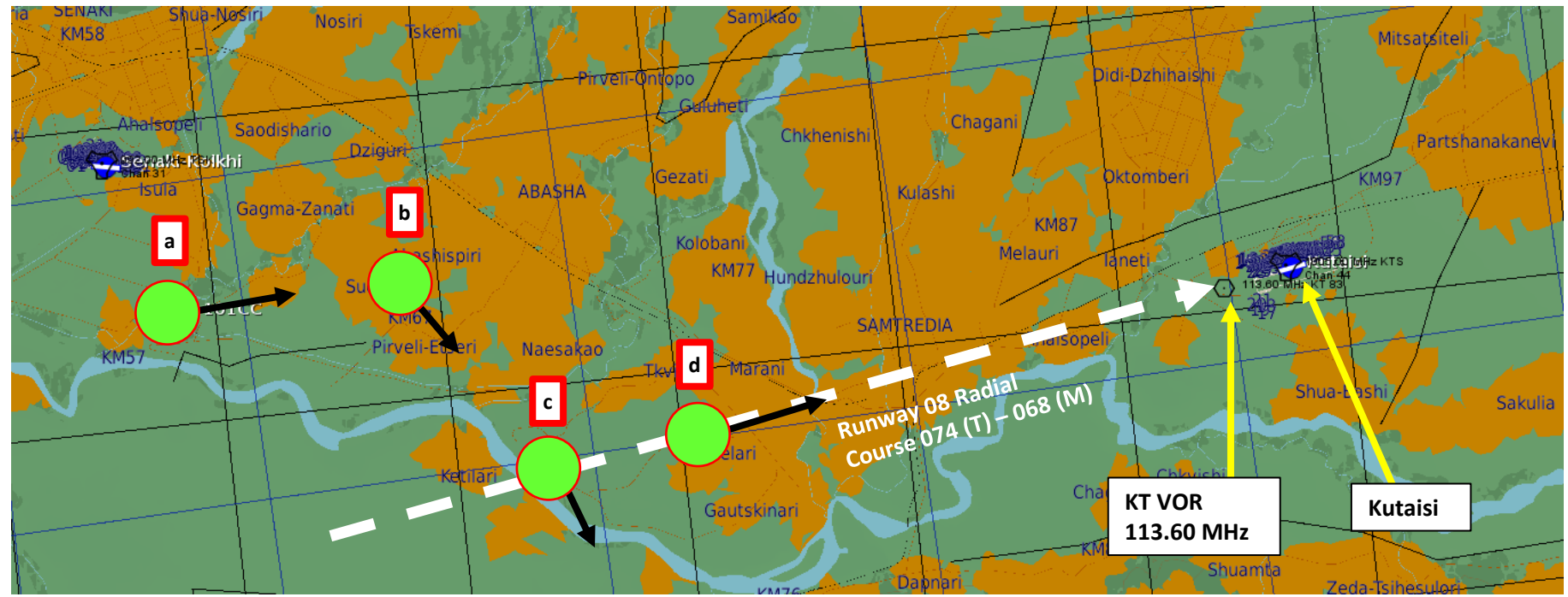


AN/ARN-127 VOR NAVIGATION TUTORIAL (C-101EB)

1. We will track the KT VOR (113.60 MHz) next to it to get a bearing information to Kutaisi.
2. Power up the NAV control panel by rotating the NAV/VOL knob.
3. Set the KT VOR's frequency (113.60) on the NAV panel by clicking on the selector knobs
4. Make sure HSI (Horizontal Situation Indicator) mode is set to VOR by checking the VOR/TACAN Bearing Light on the HSI.
5. Verify that the NAV Korry is illuminated: this means the information displayed on your HSI comes from the frequencies and modes set in your cockpit instead of the other one.
6. Set the desired course to the VOR using the HSI Course Select Remote Control knob (068)
7. Steer the aircraft towards the VOR Radial Reference Line. As you approach the radial, the line deviation with the centerline of the HSI will gradually diminish.
8. The direction of the VOR beacon will be displayed by the pointy end of the pink needle on the RMI and the yellow needle on the HSI.
9. When Reference line is centered, this means you are on the 068 radial.
10. Turn towards the VOR Heading needle to follow the radial to the runway.

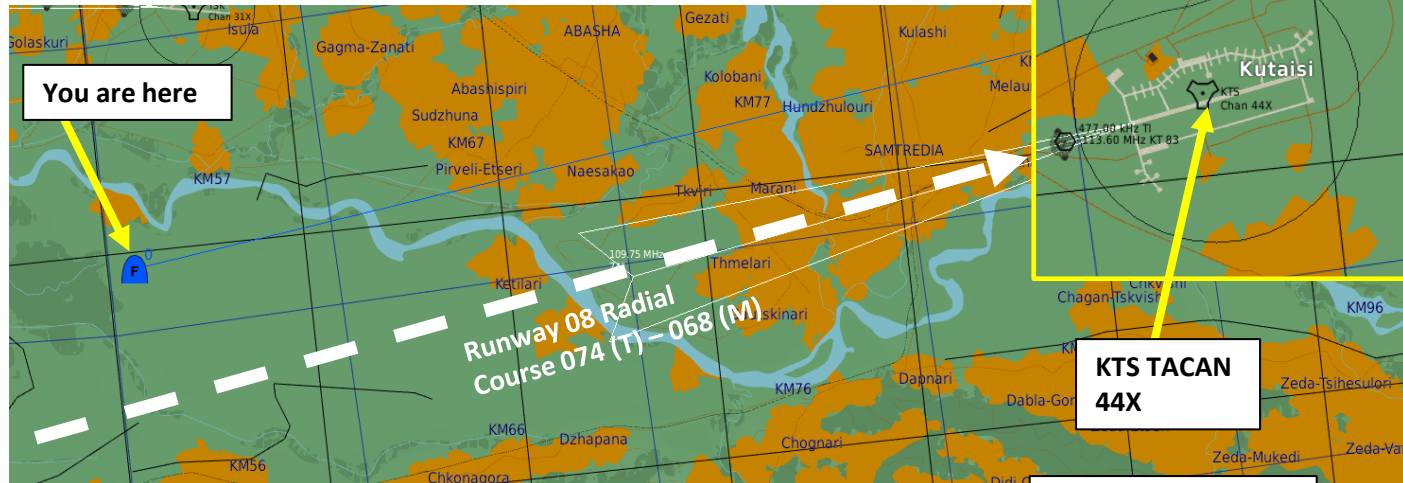


AN/ARN-127 VOR NAVIGATION TUTORIAL (C-101EB)

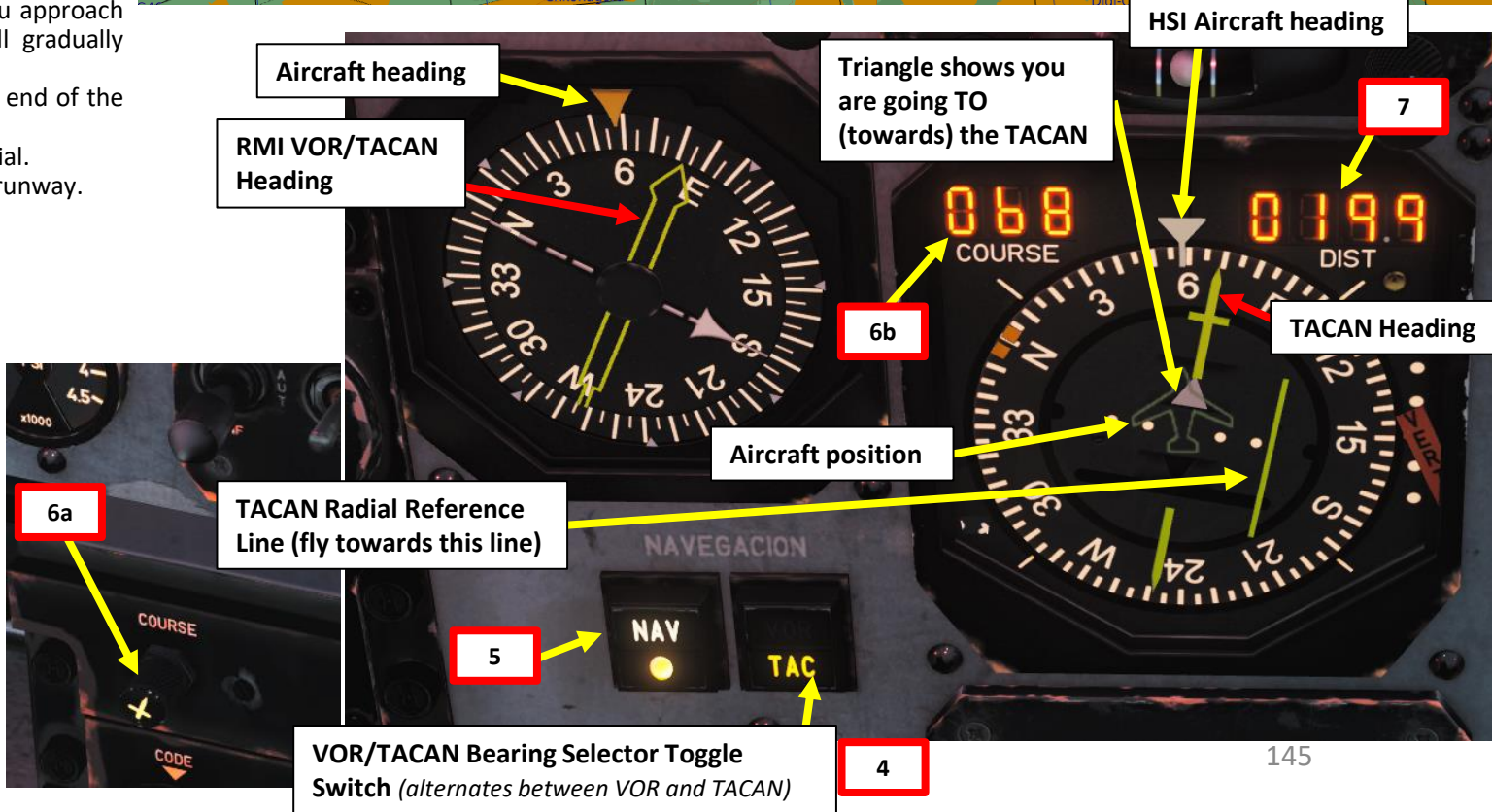


AN/ARN-118 TACAN NAVIGATION TUTORIAL (C-101EB)

1. We will track the KTS TACAN (44X) next to it to get a bearing information to Kutaisi.
2. Power up the TACAN control panel by setting the Mode Selector to T/R (Transmit-Receive).
3. Set the KTS TACAN frequency (44X) on the TACAN panel by clicking and scrolling mousewheel on the selector knobs
4. Make sure HSI (Horizontal Situation Indicator) mode is set to TAC by checking the VOR/TACAN Bearing Light on the HSI.
5. Verify that the NAV Korry is illuminated: this means the information displayed on your HSI comes from the frequencies and modes set in your cockpit instead of the other one.
6. Set the desired course to the TACAN using the HSI Course Select Remote Control knob (068)
7. After a few seconds, the HSI will display DME (Distance Measuring Equipment) distance to the TACAN in nautical miles on the DIST visor.
8. Steer the aircraft towards the TACAN Radial Reference Line. As you approach the radial, the line deviation with the centerline of the HSI will gradually diminish.
9. The direction of the TACAN beacon will be displayed by the pointy end of the yellow needle on the HSI and the yellow needle on the RMI.
10. When Reference line is centered, this means you are on the 068 radial.
11. Turn towards the TACAN Heading needle to follow the radial to the runway.

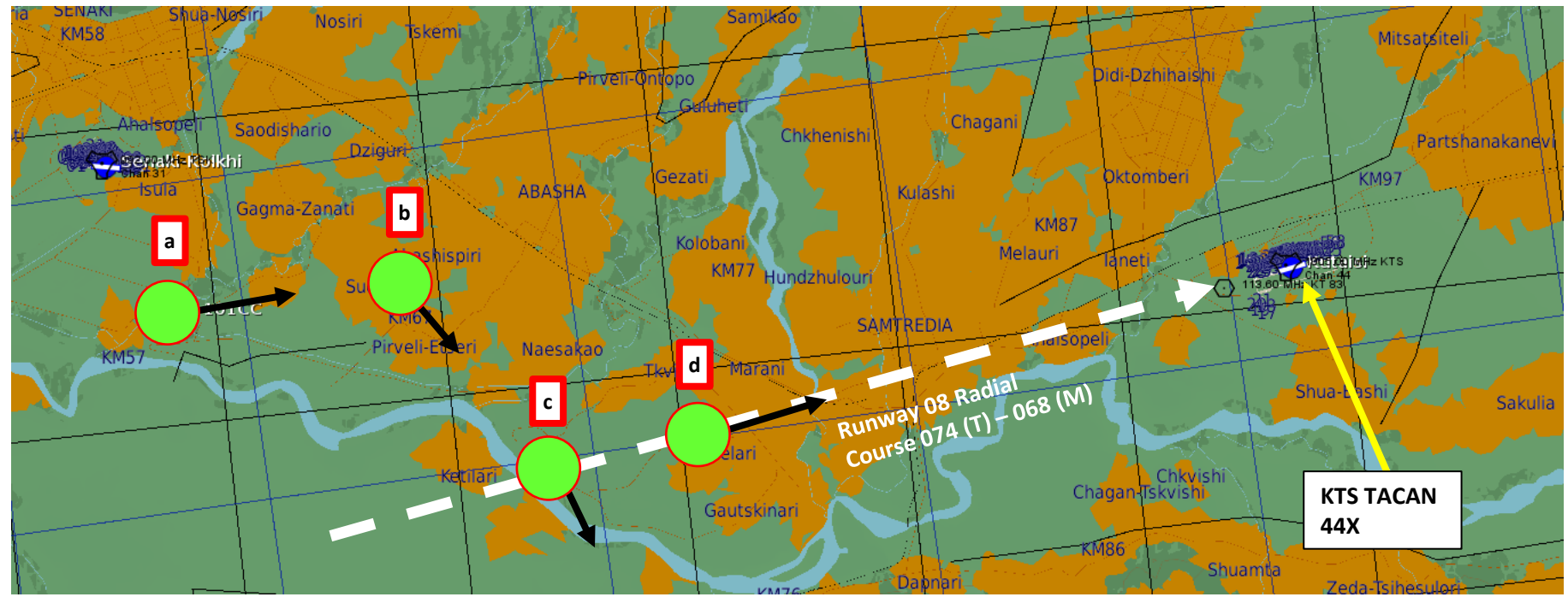


3: Right mouse click to select X/Y, scroll mousewheel to select channel number



VOR/TACAN Bearing Selector Toggle Switch (alternates between VOR and TACAN)

AN/ARN-118 TACAN NAVIGATION TUTORIAL (C-101EB)



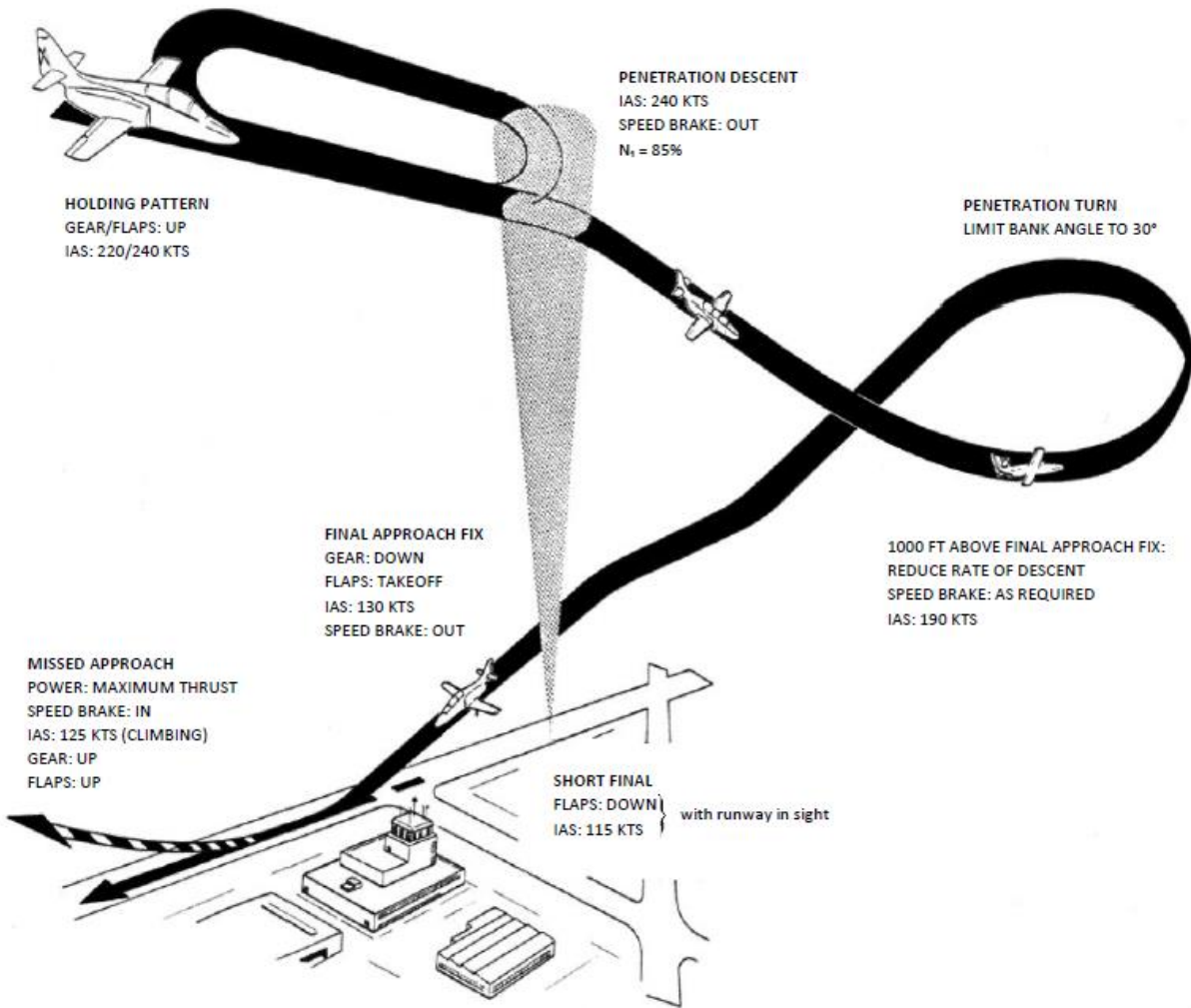
AN/ARN-118 TACAN NAVIGATION TUTORIAL [\(C-101EB\)](#)



INTRODUCTION TO PRECISION APPROACHES

In the C-101CC and C-101EB, bad weather should not be a concern. Precision approaches are easily performed with VOR (VHF Omnidirectional Range), ILS (Instrument Landing System) and TACAN systems. The VOR alone gives you lateral guidance, the TACAN gives you distance information, and the ILS gives you both lateral and vertical guidance.

VOR PENETRATION AND APPROACH (TYPICAL)



TACAN PENETRATION AND APPROACH (TYPICAL)

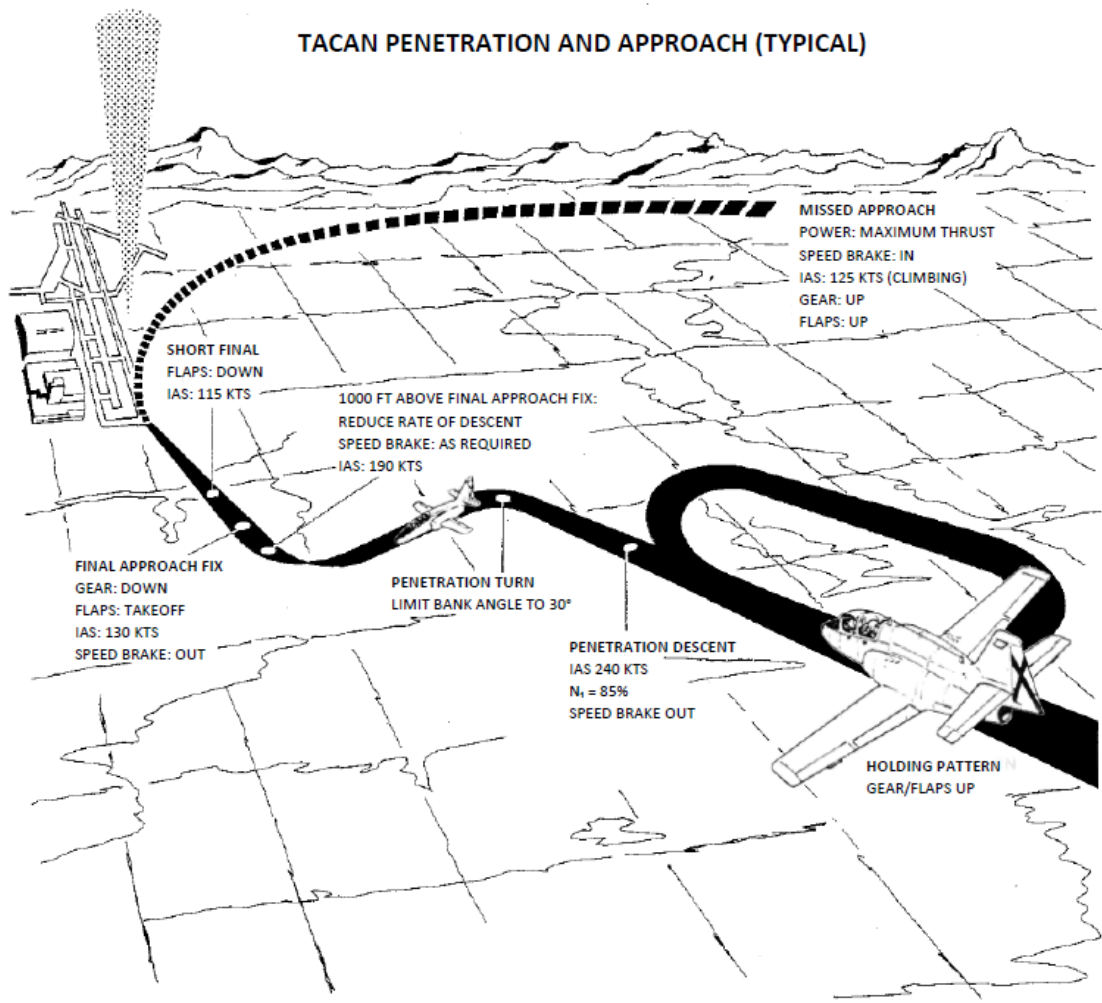


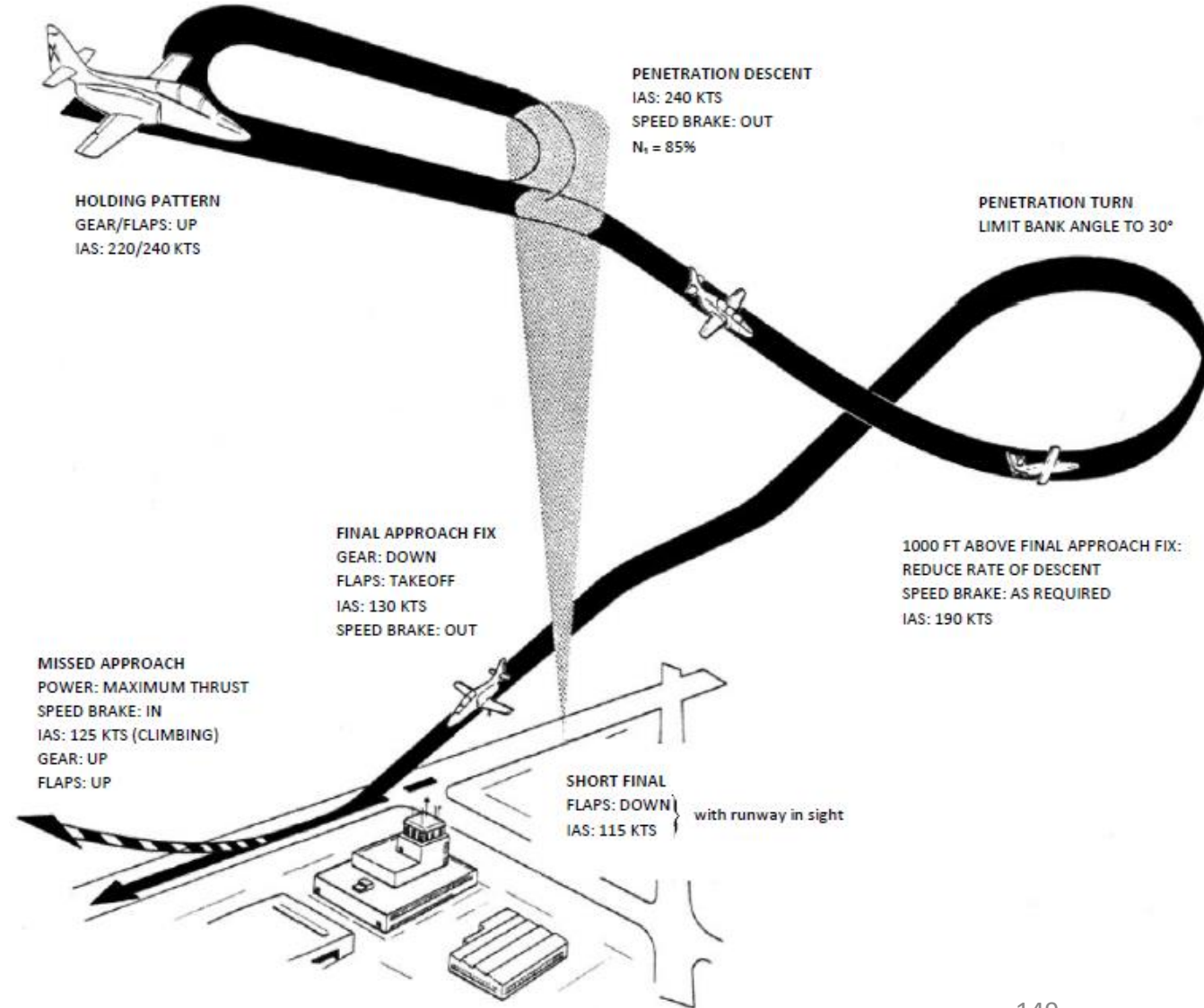
Figure 8-1 TACAN penetration

VOR APPROACH TUTORIAL

The VOR approach isn't that different from a standard ILS approach, but the only navigation aid you have at your disposal is a VOR that will give you lateral guidance but no vertical guidance. You will have to manually manage your vertical descent profile. Here are some reminders:

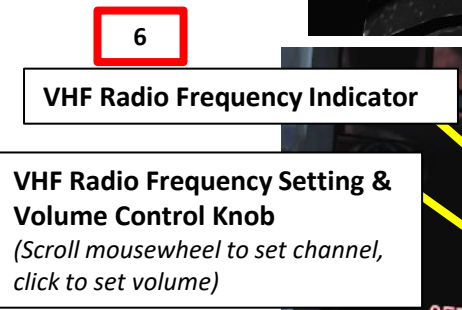
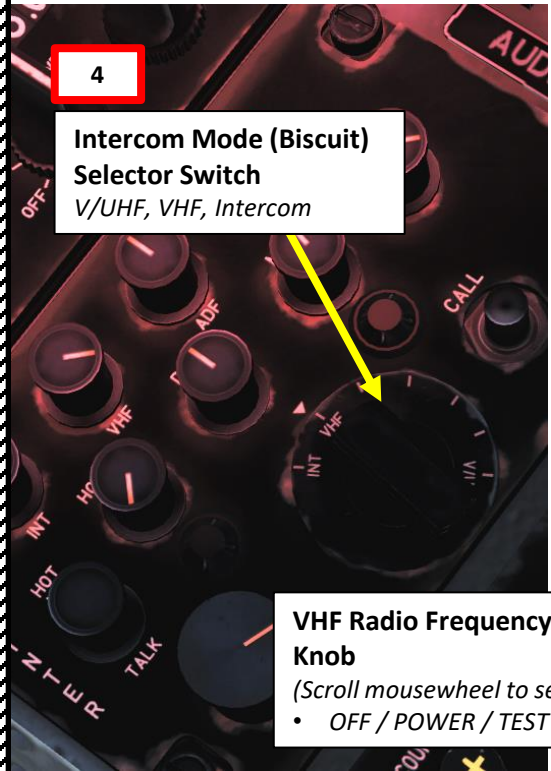
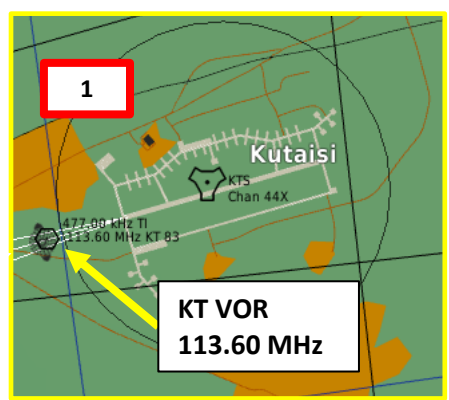
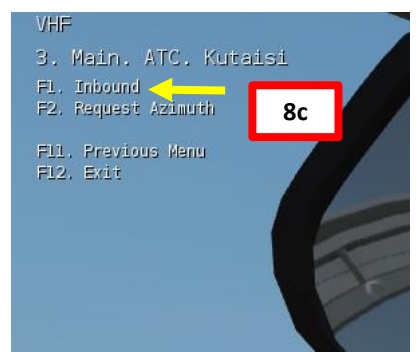
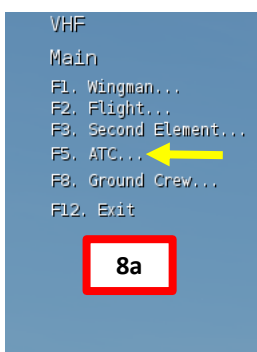
- The approach is performed by following a VOR radial that is aligned with the airport's runway
- No distance information is available with the VOR alone.
 - For the C-101CC: In the case that both a VOR and a TACAN are available, you can couple both navigation aids to get both bearing and distance information by using the DME HOLD switch as shown in the Navigation section. Your aircraft's VOR receiver alone will not give you a bearing from a TACAN; just distance information.
 - For the C-101EB: This version of the Aviojet has both bearing and distance information available from a TACAN beacon. The TACAN tutorial for the C-101EB is almost identical to this one with the difference that you use your AN/ARN-118 control panel to set the TACAN information.
- If available at an airport, Inner and Outer Marker Beacons can give you an idea of when you are about to reach the runway threshold.
- Don't forget to turn on your radar altimeter: your barometric altimeter will not take into account airport elevation.
- Don't forget to contact the airport and ask for a landing clearance. Otherwise, the airport lights will stay extinguished.
- You can use the FD (Flight Director) NAV Mode to give you steering cues on your ADI (Attitude Director Indicator).

VOR PENETRATION AND APPROACH (TYPICAL)



VOR APPROACH TUTORIAL

1. We will track the KT VOR (113.60 MHz) next to it to get a bearing information to Kutaisi.
2. Set NAV Mode selector to NAV (click mouse button).
3. Set the KT VOR's frequency (113.60) on the NAV panel by scrolling mousewheel
4. Set Intercom Mode Selector to VHF
5. Set Radio Mode Control to POWER (Click mouse button).
6. Tune VHF frequency manually to the Kutaisi tower: 134.000 MHz. Scrolling mousewheel on both VHF Radio Frequency Setting knobs
7. Use microphone switch (on throttle) to communicate on set frequency (Communication Menu = "\ " binding).
8. Select F5 (ATC), Kutaisi, and Request approach clearance (F1 - Inbound)



VHF Radio Frequency Setting & Volume Control Knob
(Scroll mousewheel to set channel, click to set volume)

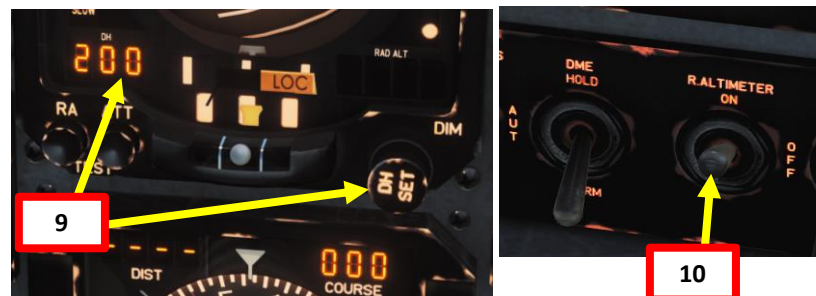
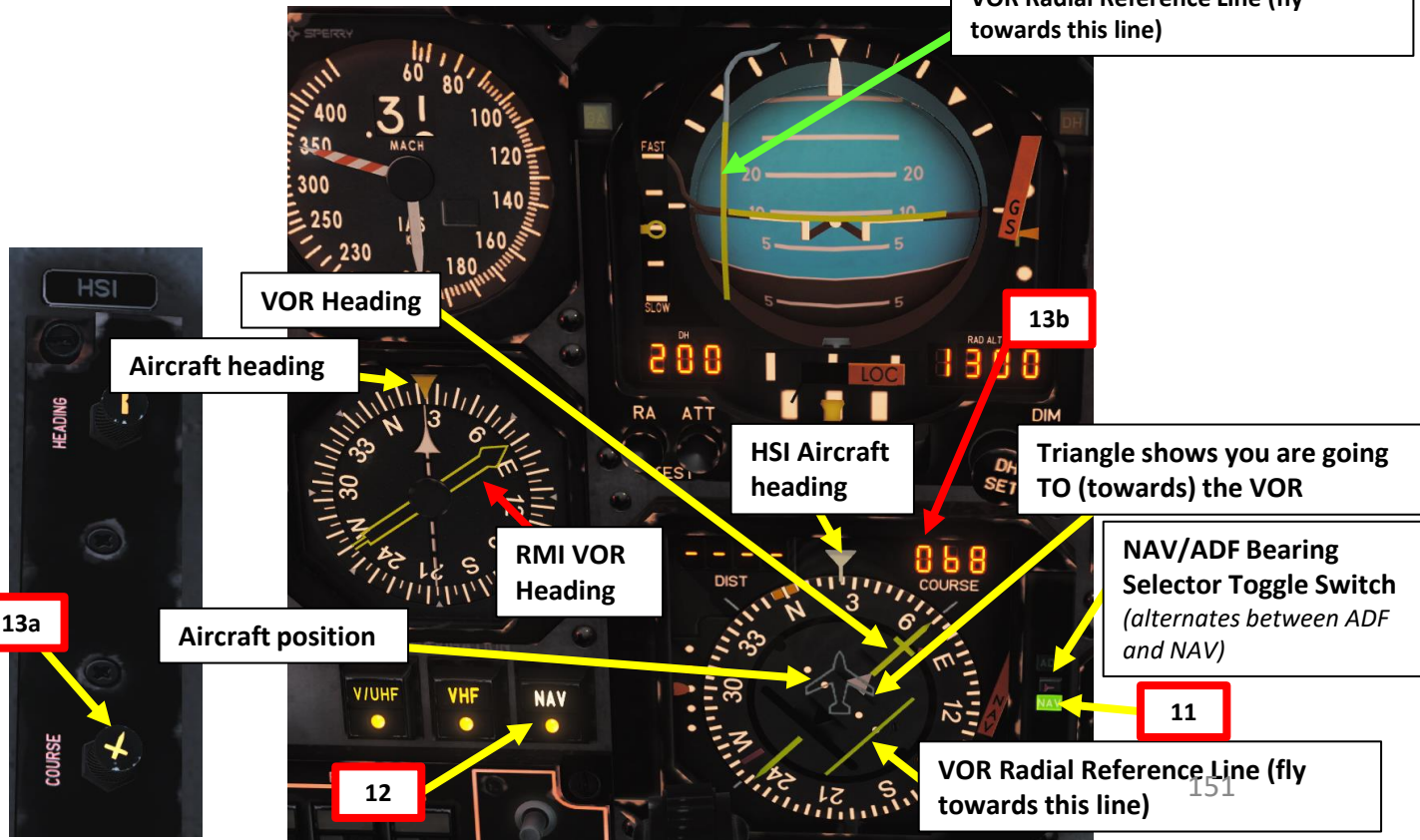
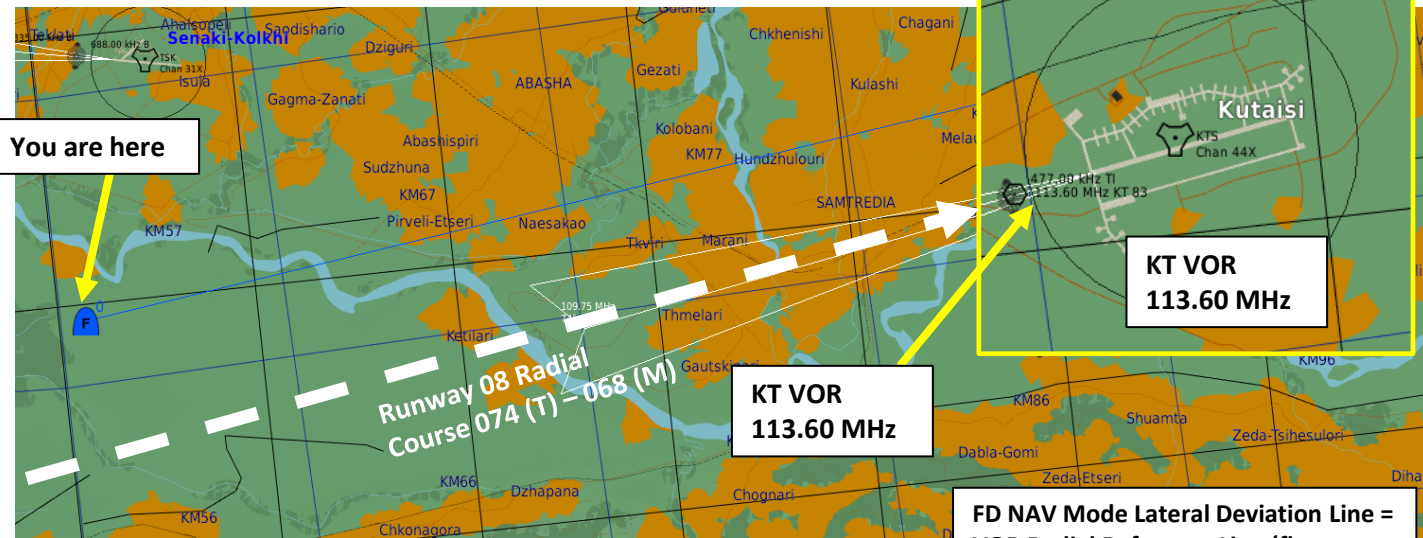


AIRDROME DATA	
NAME	Kutaisi
ICAO	UGKO
COALITION	Neutral
ELEVATION	147 ft
RWY Length	7937 ft
COORDINATES	42°10'44" N 42°29'44" E
TACAN	44X (KTS)
VOR	113.60 (KT)
RSBN	--
ATC	4,400, 134,000, 41,000, 263,000
RWYs	26 8
ILS	-- 109.75 (IKS)
PRMG	-- --
OUTER NDB	-- --
INNER NDB	-- --

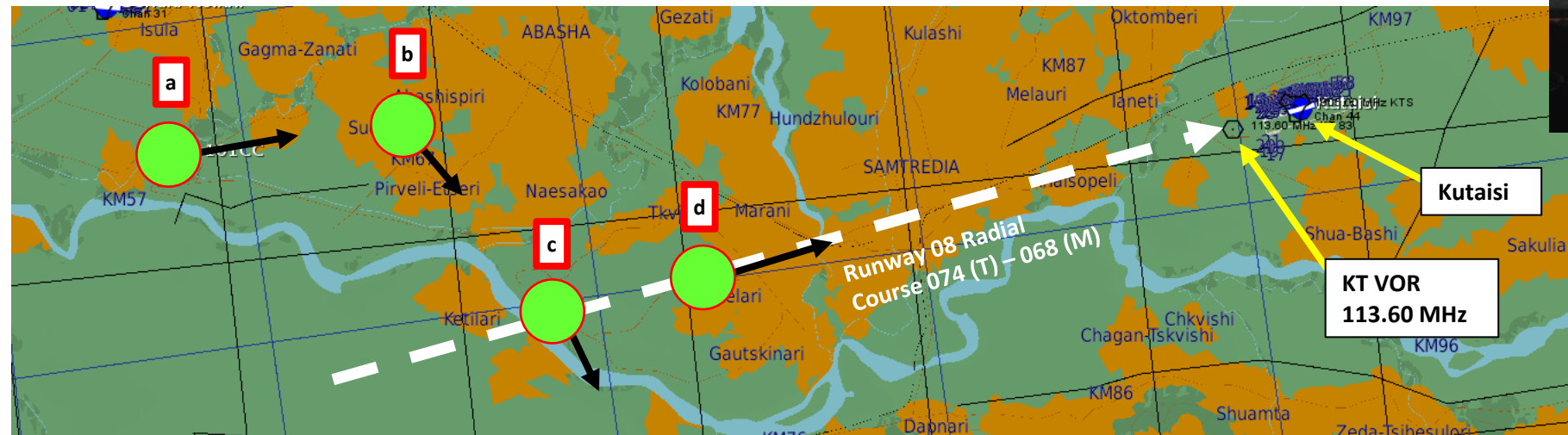


VOR APPROACH TUTORIAL

9. Set Decision Height to 200 ft
10. Set Radio Altimeter Switch – ON (UP)
11. Make sure HSI (Horizontal Situation Indicator) mode is still set to NAV by checking the NAV Bearing Light on the HSI.
12. Verify that the NAV Korry is illuminated: this means the information displayed on your HSI comes from the frequencies and modes set in your cockpit instead of the other one.
13. Set the desired course to the VOR using the HSI Course Select Remote Control knob (068)
14. Arm the Flight Director NAV mode (or press the VOR APR mode button, which will arm the NAV mode automatically). When VOR signal is captured, the CAP light will illuminate.
15. Steer the aircraft towards the VOR Radial Reference Line. You can follow the FD NAV Mode vertical line as a reference too. As you approach the radial, the line deviation with the centerline of the HSI will gradually diminish.
16. The direction of the VOR beacon will be displayed by the pointy end of the yellow needle on the HSI and the yellow needle on the RMI.
17. When Reference line is centered, this means you are on the 068 radial.
18. Turn towards the VOR Heading needle to follow the radial to the runway.



VOR APPROACH TUTORIAL



VOR APPROACH TUTORIAL

19. As you are heading towards the runway, descend to 1000 ft above ground level. Use your radio altimeter for altitude reference. Descend at 190 kts.
20. Speed brake – Out
21. Landing Gear Lever – Down
22. Flaps Lever – Down
23. Landing Lights – Land (DOWN)
24. Stay aligned with the runway by keeping the FD vertical bar centered on the ADI
25. When you are approaching the airport, the ATC will contact you. You can now request landing clearance.
26. Slow down to 130 kts for final segment, then 115 kts in short final (with runway in sight). When you have the runway in sight, disregard the FD NAV Mode vertical bar since it will be unreliable as you fly over it.



25

23

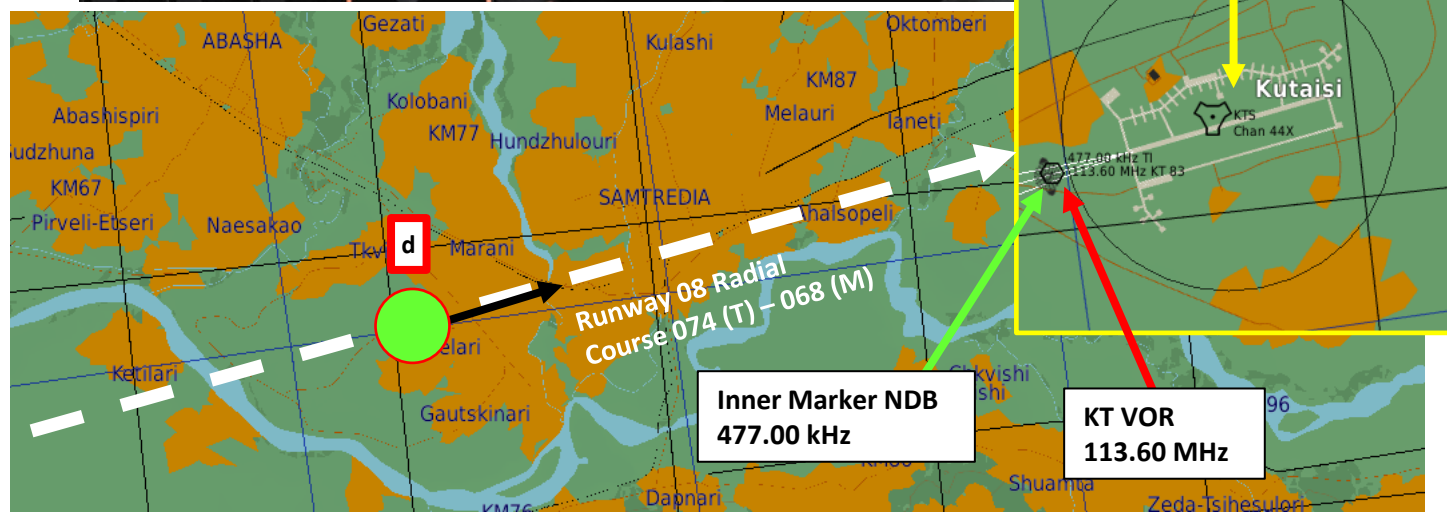
ATC (Kutaisi): Enfield 1-1, cleared for visual, contact tower

VHF
 Kutaisi. Arrival. Ready to land
 F1. Request Landing ←
 F2. Abort Inbound
 F3. Request Azimuth

 F11. Parent Menu
 F12. Exit

PLAYER: Kutaisi, Enfield 1-1, request landing

PLAYER: Kutaisi, Enfield 1-1, request landing
 ATC (Kutaisi): Enfield 1-1, Kutaisi, cleared to land, runway 08, wind 106 at 10 meters per second



Inner Marker NDB
477.00 kHz

KT VOR
113.60 MHz

VOR APPROACH TUTORIAL

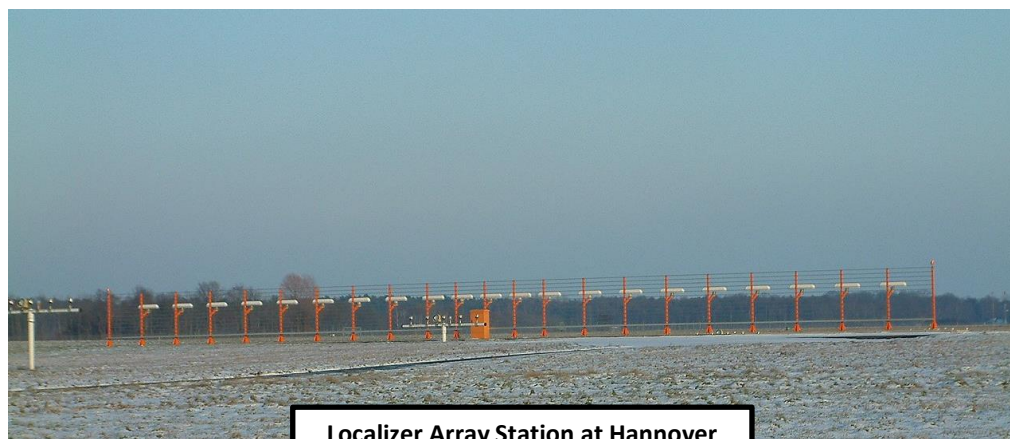
27. The Inner Marker light should illuminate with an aural warning once you overfly it
28. Flare the aircraft at 110 kts over the threshold and touch down at 95 kts on the main landing gears.



ILS APPROACH TUTORIAL

The ILS (Instrument Landing System) exists to guide you during your approach.

- The Localizer is generally an array of antennas that will give you a lateral reference to the center of the runway.
- The Glide Slope station will help you determine the descent speed you need in order to not smack the runway in a smoldering ball of fire.

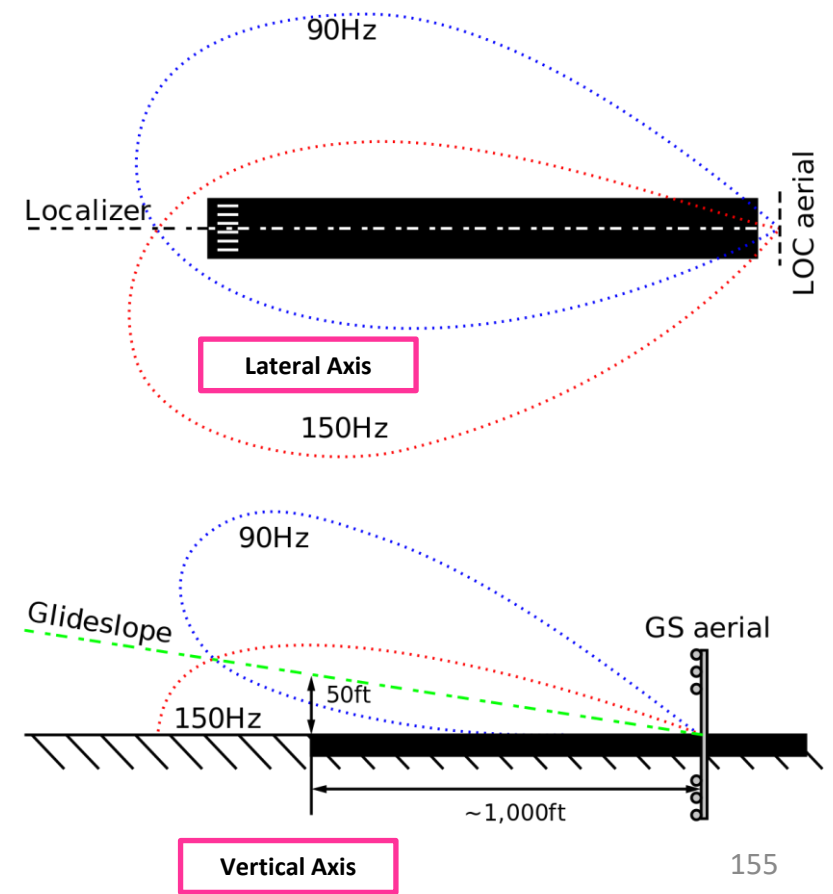
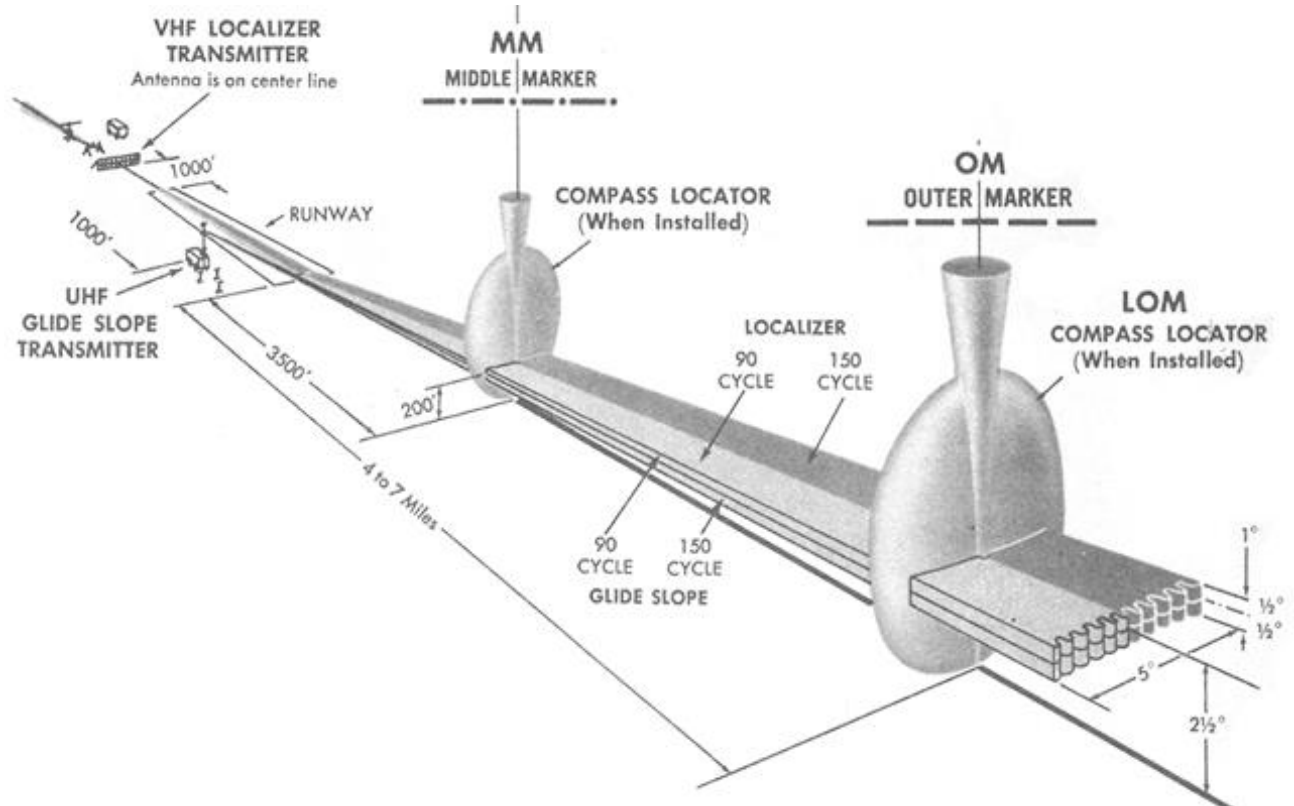


Localizer Array Station at Hannover



Glide Slope Station at Hannover

Great video explanation of ILS
<https://www.youtube.com/watch?v=KVtEfDcNMO8>



ILS APPROACH TUTORIAL

MISSION EDITOR FILE EDIT FLIGHT CAMPAIGN CUSTOMIZE MISSION GENERATOR MISC

FILE MIS OBJ MAP

You are here

Senaki Runway 09 ILS
Course: 095 (T) – 089 (M)
Frequency: 108.90 MHz

Runway 09 ILS
Course 095 (T) – 089 (M)

Senaki-Kolkhi Airport
Runway 09

Outer Marker NDB
335.00 kHz

Inner Marker NDB
688.00 kHz

108.90 MHz
95°

335.00 kHz B
688.00 kHz B

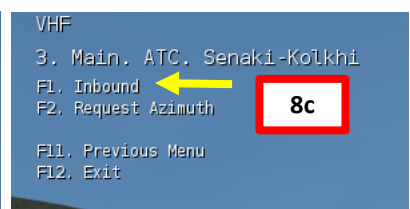
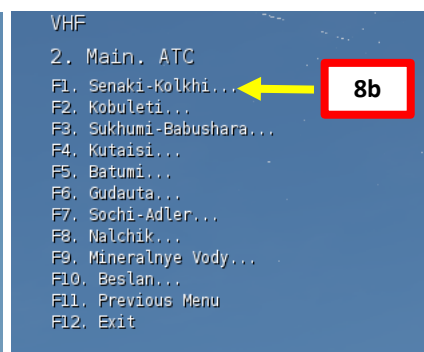
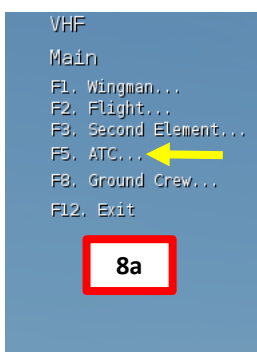
2 nm

DFLT tempMission.miz LAT 42°19'12" N LONG 41°51'45" E ALT 30 PAN/SELECT MAP SAT ALT

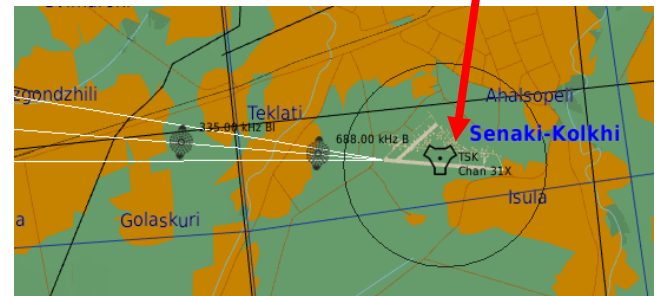
156
15.03.2019 22:04:20

ILS APPROACH TUTORIAL

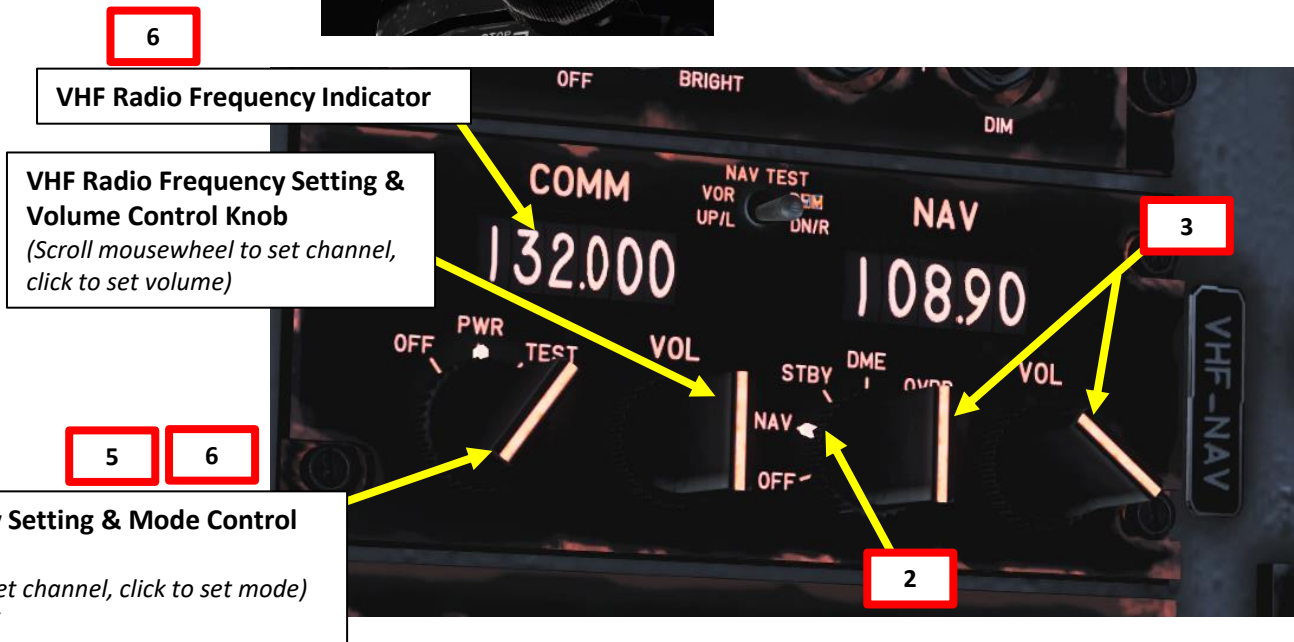
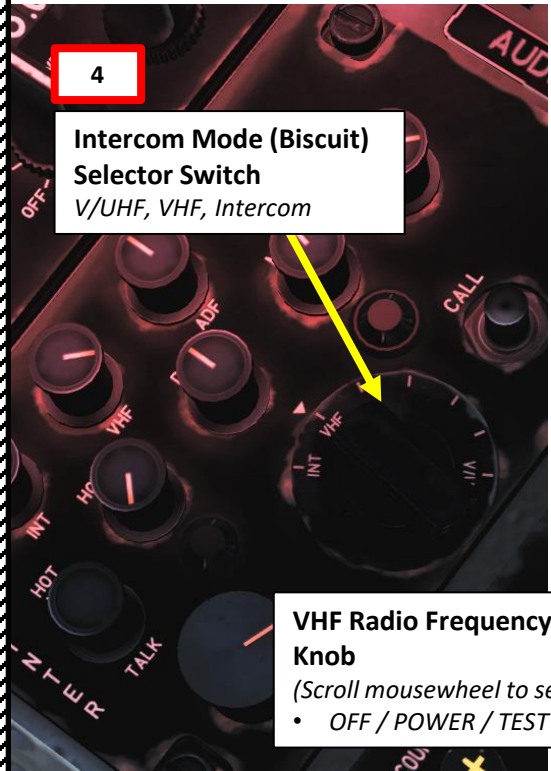
1. We will track Senaki's Runway 09 ILS (108.90 MHz).
2. Set NAV Mode selector to NAV (click mouse button).
3. Set the Senaki ILS frequency (108.90) on the NAV panel by scrolling mousewheel
4. Set Intercom Mode Selector to VHF
5. Set Radio Mode Control to POWER (Click mouse button).
6. Tune VHF frequency manually to the Senaki tower: 132.000 MHz. Scrolling mousewheel on both VHF Radio Frequency Setting knobs
7. Use microphone switch (on throttle) to communicate on set frequency (Communication Menu = "\" binding).
8. Select F5 (ATC), Senaki, and Request approach clearance (F1 - Inbound)



1 **Senaki Runway 09 ILS**
Course: 095 (T) – 089 (M)
Frequency: 108.90 MHz



8d **Main | Kolkhi. Arrival. Inbound**
PLAYER: Kolkhi, Enfield 1-1, inbound
ATC (Kolkhi): Enfield 1-1, Kolkhi, fly heading 100 for 13, QFE 29.29, runway 09, to pattern altitude



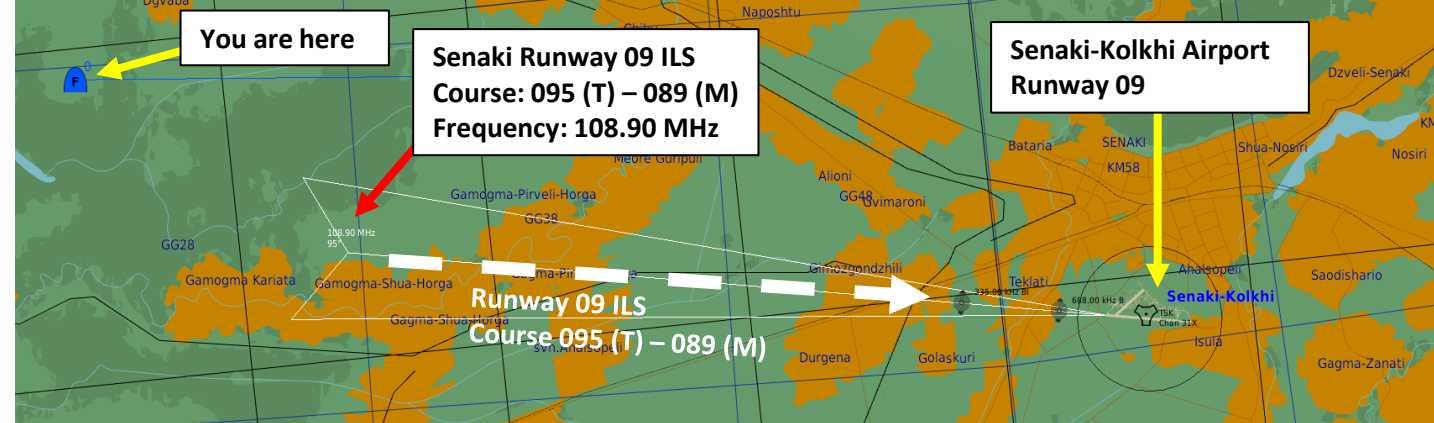
AIRDROME DATA

NAME	Senaki-Kolkhi
ICAO	UGKS
COALITION	Blue
ELEVATION	43 ft
RWY Length	7256 ft
COORDINATES	42°14'19"N 42°03'39"E
TACAN	31X (TSK)
VOR	--
RSBN	--
ATC	4,300, 132,000, 40,600, 261,000
RWYs	27 9
ILS	-- 108.90 (ITS)
PRMG	-- --
OUTER NDB	-- 335.00 (BI)
INNER NDB	-- 688.00 (B)

RESOURCES

ILS APPROACH TUTORIAL

9. Set Decision Height to 200 ft
10. Set Radio Altimeter Switch – ON (UP)
11. Make sure HSI (Horizontal Situation Indicator) mode is still set to NAV by checking the NAV Bearing Light on the HSI.
12. Verify that the NAV Korry is illuminated: this means the information displayed on your HSI comes from the frequencies and modes set in your cockpit instead of the other one.
13. Set the desired course to the VOR using the HSI Course Select Remote Control knob (089)



ILS APPROACH TUTORIAL

14. Maintain 2000 ft of altitude for now.
15. When you are about 10-15 nm from Senaki, the LOC flag should disappear and the localizer signal should be detected. The localizer symbol will become live.
16. Press APR button to arm the Flight Director Approach mode. The HDG FD mode will automatically engage. The NAV (localizer detection) and APR (glide slope detection) modes will automatically arm themselves. Take note that the NAV mode will automatically engage when the localizer is captured (CAP light will appear) and that the APR mode will automatically engage when the glide slope is capture (CAP will appear as well).
17. I suggest setting the ALT FD Mode to help you maintain your 2000 ft.
18. Steer the aircraft towards the Localizer symbol. (i.e. if the LOC symbol is to the right of the centerline, steer the aircraft to the right towards the symbol). As you approach the ILS radial 089, the LOC symbol will align itself with the centerline.



15 No LOC Fail Flag = Localizer Detected

16

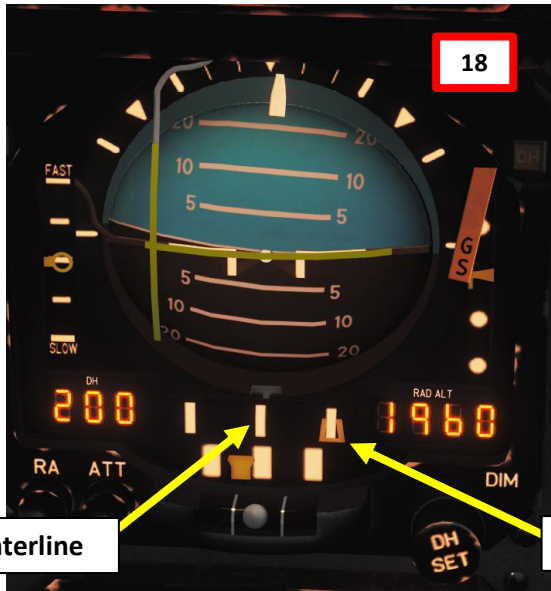
HDG FD Mode Active

ALT FD Mode Active

17

APR FD Mode Armed

NAV FD Mode Armed

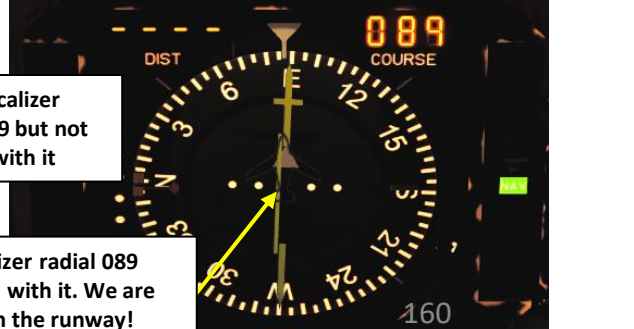
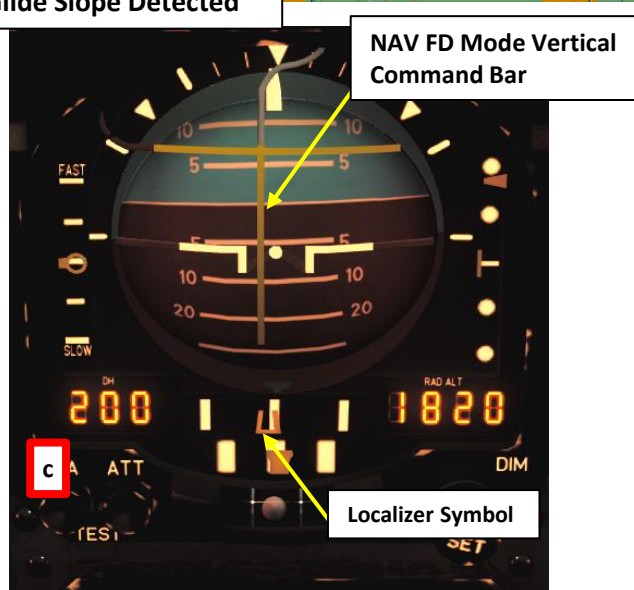
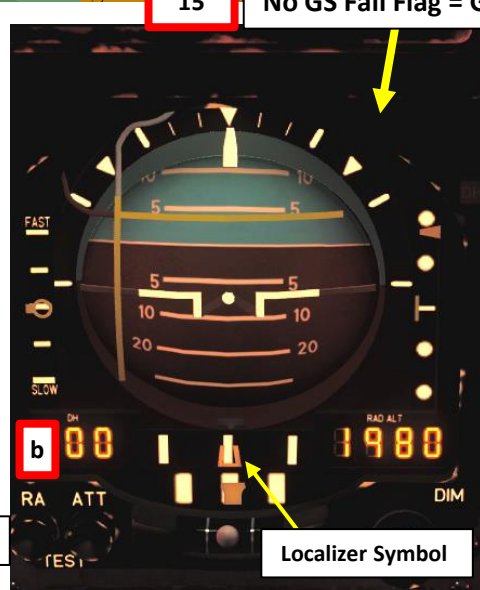
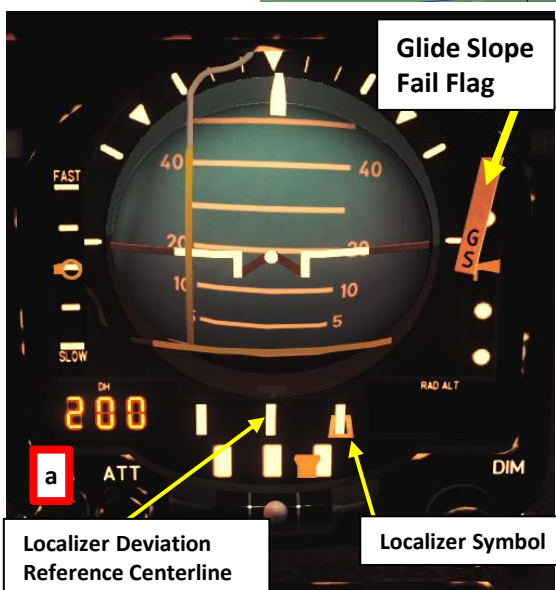
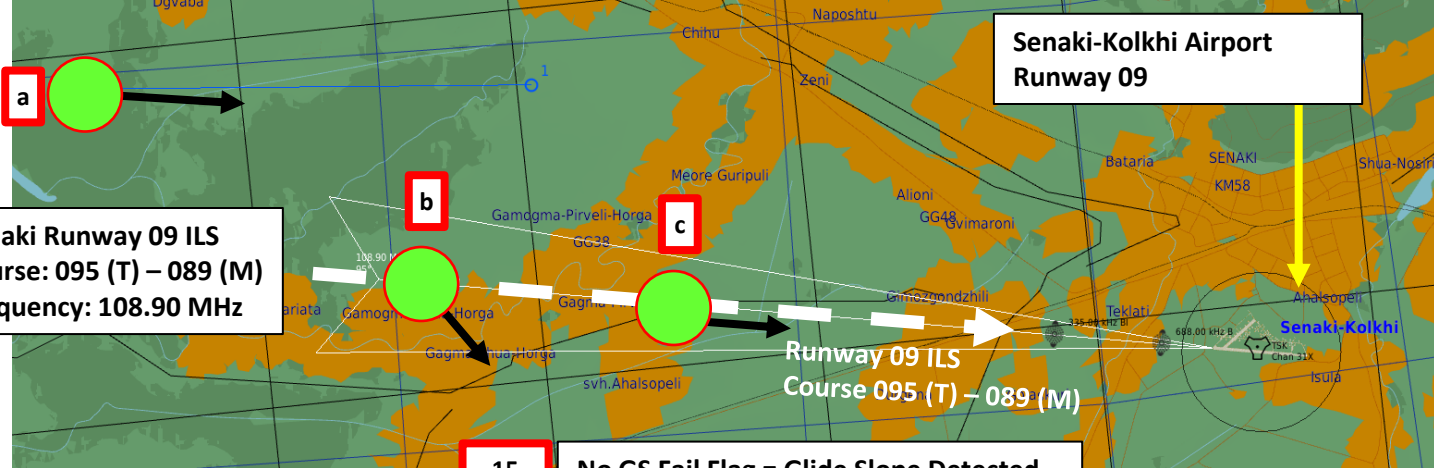


Centerline

Localizer Symbol (Orange)

ILS APPROACH TUTORIAL

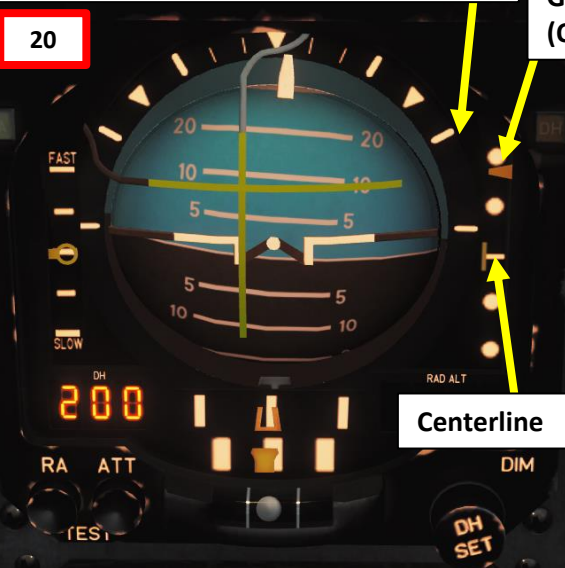
19. As we align ourselves laterally with the localizer, the Flight Director NAV (Localizer) mode will be captured (CAP). This means that we can follow the vertical FD command bar.



ILS APPROACH TUTORIAL

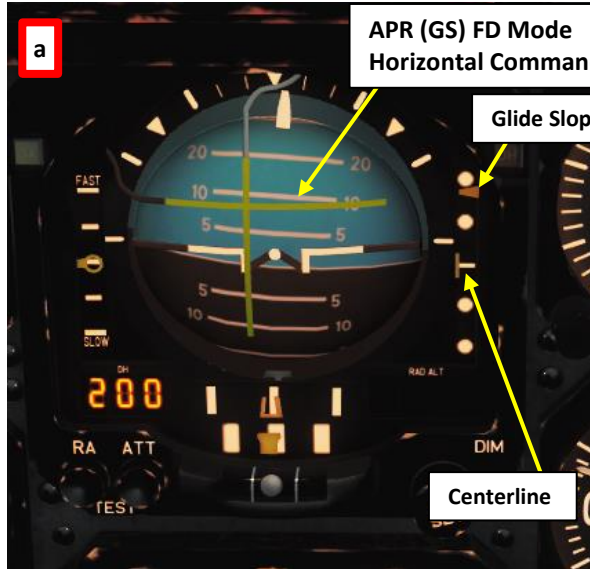
20. When the GS flag disappears from the ADI, the APR glide slope signal should be detected. The glide slope symbol will become live.
21. Climb or descend the aircraft towards the Glide Slope symbol. (i.e. if the GS symbol is above the centerline, pitch up towards the symbol). As you set up your approach, the GS symbol will align itself with the centerline.
22. As we align ourselves vertically with the glide slope, the Flight Director APR (Glide Slope Approach) mode will be captured (CAP). This means that we can follow the horizontal FD command bar.

No GS Fail Flag = Glide Slope Detected

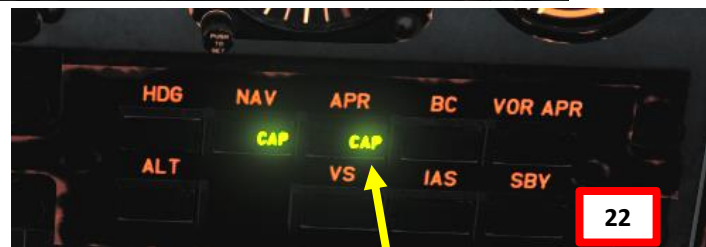


Glide Slope Symbol (Orange)

APR (GS) FD Command Bar aligned = We are on glide slope



Glide Slope Symbol = Aligned on centerline



APR FD Mode Captured



ILS APPROACH TUTORIAL

23. As you are heading towards the runway and descend to 1000 ft above ground level, use your radio altimeter for altitude reference. Descend at 190 kts.
24. Speed brake – Out
25. Landing Gear Lever – Down
26. Flaps Lever – Down
27. Landing Lights – Land (DOWN)
28. Stay aligned with the runway by keeping the FD vertical and horizontal bars centered on the ADI
29. When you are approaching the airport, the ATC will contact you. You can now request landing clearance.
30. Slow down to 130 kts for final segment, then 115 kts in short final (with runway in sight).
31. The Outer and Inner Marker lights should illuminate with an aural warning once you overfly them



29



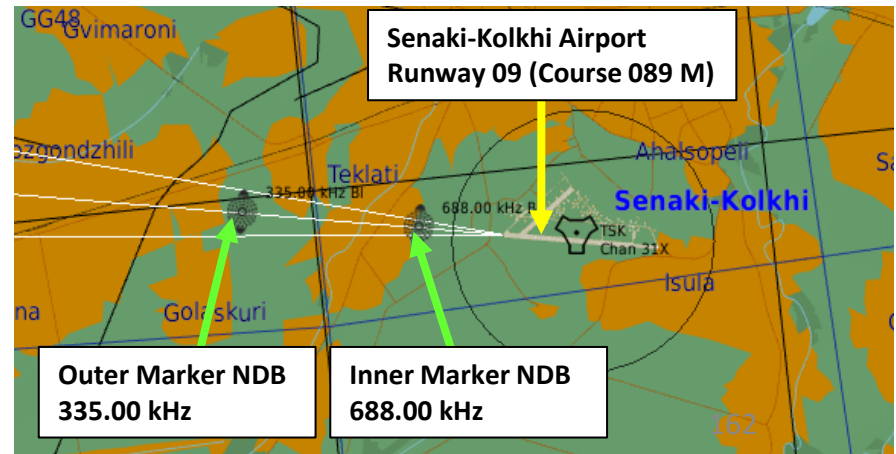
ATC (Kolkhi): Enfield 1-1, cleared for visual, contact tower

VHF
Kolkhi. Arrival. Ready to land
F1. Request Landing
F2. Abort Inbound
F3. Request Azimuth

F11. Parent Menu
F12. Exit

PLAYER: Kolkhi, Enfield 1-1, request landing

ATC (Kolkhi): Enfield 1-1, Kolkhi, check landing gear, wind 106 at 10 meters per second, runway 09



ILS APPROACH TUTORIAL

32. Flare the aircraft at 110 kts over the threshold and touch down at 95 kts on the main landing gears.



SMOKE GENERATION SYSTEM

To Deploy Smoke:

1. Verify that Smoke & Colorant is equipped on the aircraft
2. Close the circuit breakers (IN) labelled *HUMOS BLANCOS* (White Smoke) and *HUMOS COLOR* (Color Smoke).
3. Press the Stores Release Button in the control stick to start smoke jettisoning ([T] key binding).
4. Press the Fixed Weapons Release Button in the control stick for colorant. ([LSHIFT+T] key binding).

To De-Activate Smoke:

- a) Press the Fixed Weapons Release Button in the control stick to stop colorant.
- b) Press the Stores Release Button in the control stick to stop smoke jettisoning.
- c) Open the circuit breakers (OUT) labelled *HUMOS BLANCOS* (White Smoke) and *HUMOS COLOR* (Color Smoke) if required.



Smoke system electrically de-energized.



HUMO BLANCO CERRADO (WHITE SMOKE CLOSED)
Smoke system electrically energized and smoke system valve closed, no smoke is being jettisoned.

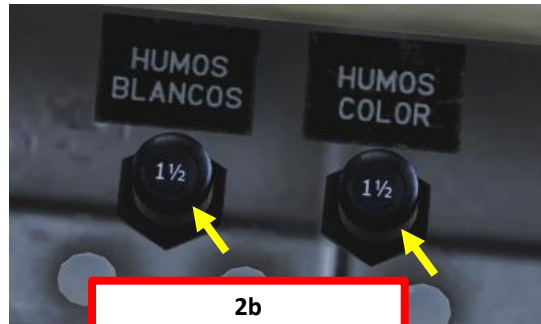
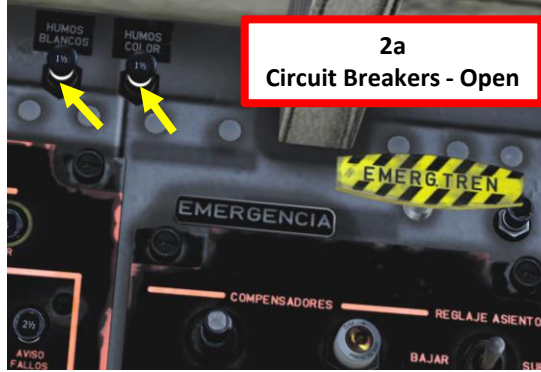


HUMO BLANCO ABIERTO (WHITE SMOKE OPENED)
Smoke system valve opened, smoke is being jettisoned.



ATENCIÓN HUMO DE COLOR (ATTENTION COLOR SMOKE)
Colorant valve opened, colorant is being added to smoke system.

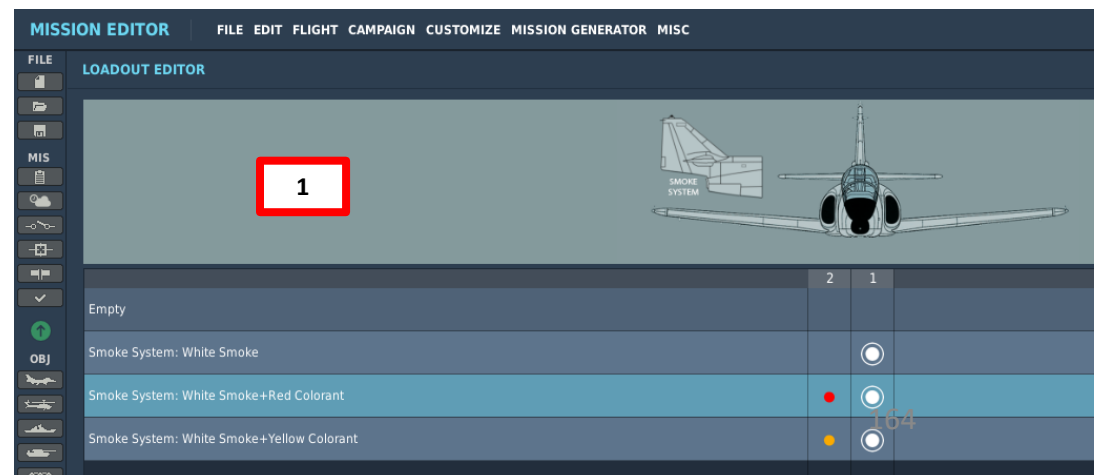
Figure 10-3 Control Panel



Note: the smoke system function is inhibited when wheels are on ground.

Figure 10-4 Control Stick Buttons

- 1 STORES RELEASE BUTTON (WHITE SMOKE)
- 2 FIXED WEAPONS TRIGGER (COLORANT)



C-101EB
AVIOJET



PART 14 – C-101EB SMOKE EQUIPMENT



EMERGENCY PROCEDURES

5.1. WHEEL BRAKE FAILURE

Brake failure will occur as a result of complete hydraulic pressure loss.

1 PARKING/EMERGENCY BRAKE	APPLY
---------------------------	-------

5.2. REJECTED TAKEOFF

1 POWER LEVER	IDLE
---------------	------

2 BRAKES	NORMAL or EMERGENCY
----------	---------------------

5.3. ENGINE FAILURE/FIRE DURING TAKEOFF

If takeoff is refused:

1 POWER LEVER	IDLE
---------------	------

2 BRAKES	EMERGENCY
----------	-----------

If takeoff is continued:

1 POWER LEVER	MAX
---------------	-----

5.4. EJECTION

1 CORRECT POSTURE	ADOPT
-------------------	-------

2 EJECTION SEAT FIRING HANDLE	PULL
-------------------------------	------

WARNING: It is essential that the pilot in the rear cockpit keeps his head below the canopy breakers. Failure to do this could result in severe or fatal injuries.

5.5. ENGINE FIRE IN FLIGHT

1 POWER LEVER	IDLE
---------------	------

2 POWER LEVER	STOP
---------------	------

3 FUEL SHUTOFF VALVE	CLOSE
----------------------	-------

If the fire continues:

4 EJECT IMMEDIATELY

5.6. ENGINE DAMAGED IN FLIGHT

1 POWER LEVER	IDLE
---------------	------

2 DO NOT ATTEMPT A RESTART

5.7. IN-FLIGHT RESTART

1 POWER LEVER	IDLE
---------------	------

2 IGNITION	START
------------	-------

5.8. OUT-OF-CONTROL RECOVERY

If sufficient altitude is available:

1 STICK and RUDDER	NEUTRAL
--------------------	---------

Recovery from most out-of-control situations can be effected rapidly by neutralizing the control stick and the rudder.

2 POWER LEVER	IDLE (unless at low altitude)
---------------	-------------------------------

The power lever should be retarded to IDLE to reduce the possibility of engine flame-out unless at low altitude where thrust may be needed for recovery.

Recovery from an out-of-control condition may result in a minimum loss of altitude of 800 - 1500 feet. Avoid buffeting during recovery.

Without sufficient altitude to recover:

3 EJECT IMMEDIATELY

EMERGENCY PROCEDURES

5.9. MAXIMUM GLIDE DISTANCE

Maximum glide distance is attained in clean configuration (flaps, speed brake and gear retracted) and maintaining the recommended gliding airspeeds from the following table, which results in the best glide angle (L/D max).

Rule of thumb: the aircraft will glide 2 nautical miles each 1000 feet of altitude.

FUEL REMAINING IN LBS	GLIDE SPEED IN KCAS
350	125
950	130
1650	135
2300	140
3000	145
3600	150

Figure 5-1 Best glide speed

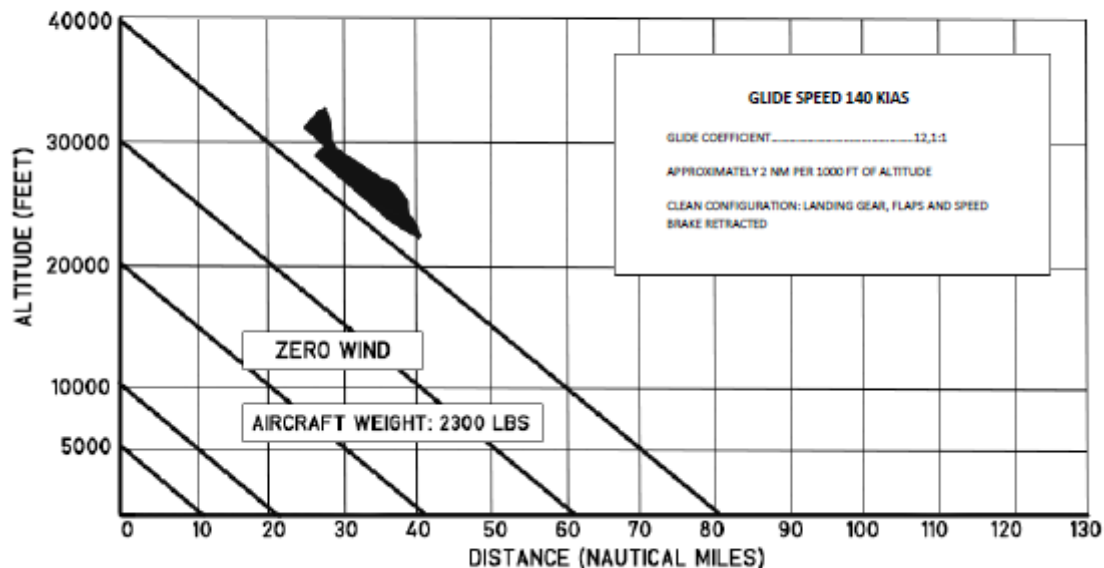


Figure 5-2 Maximum gliding distance

5.10. EMERGENCY GEAR EXTENSION

1 AIRSPEED	BELOW 150 KIAS
2 LANDING GEAR (TREN) CIRCUIT BREAKER	OPEN
3 EMERGENCY GEAR EXTENSION HANDLE	PULL

5.11. HYDRAULIC SYSTEM FAILURE

PRES. HDR. (HYD PRES) warning light illuminates in red when the pressure drops below 2000 psi. The following conditions result:

- Loss of Aileron Servo-actuator. (After accumulator pressure is exhausted).
- Speed brake inoperative.
- Landing gear extension by emergency pneumatic system only.
- Landing gear cannot be retracted.
- Flaps inoperative.
- Emergency braking only. Normal braking inoperative.
- Anti-Skid inoperative.

If a hydraulic system failure occurs:

1 LAND AS SOON AS PRACTICAL	
2 LANDING GEAR	EMERGENCY EXTENSION
See emergency gear extension procedure.	
3 FLAPLESS APPROACH	
See flame-out landing speeds table. Do not fly below those speeds.	

EMERGENCY PROCEDURES

5.12. FLAME-OUT LANDING

FLAME-OUT APPROACH SPEEDS		
FUEL REMAINING lb	SPEED AT POINTS ① ② ③ KIAS	SPEED AT POINT ④ KIAS
355	135	120
1020	140	125
1677	145	130
2340	150	135
3000	155	140

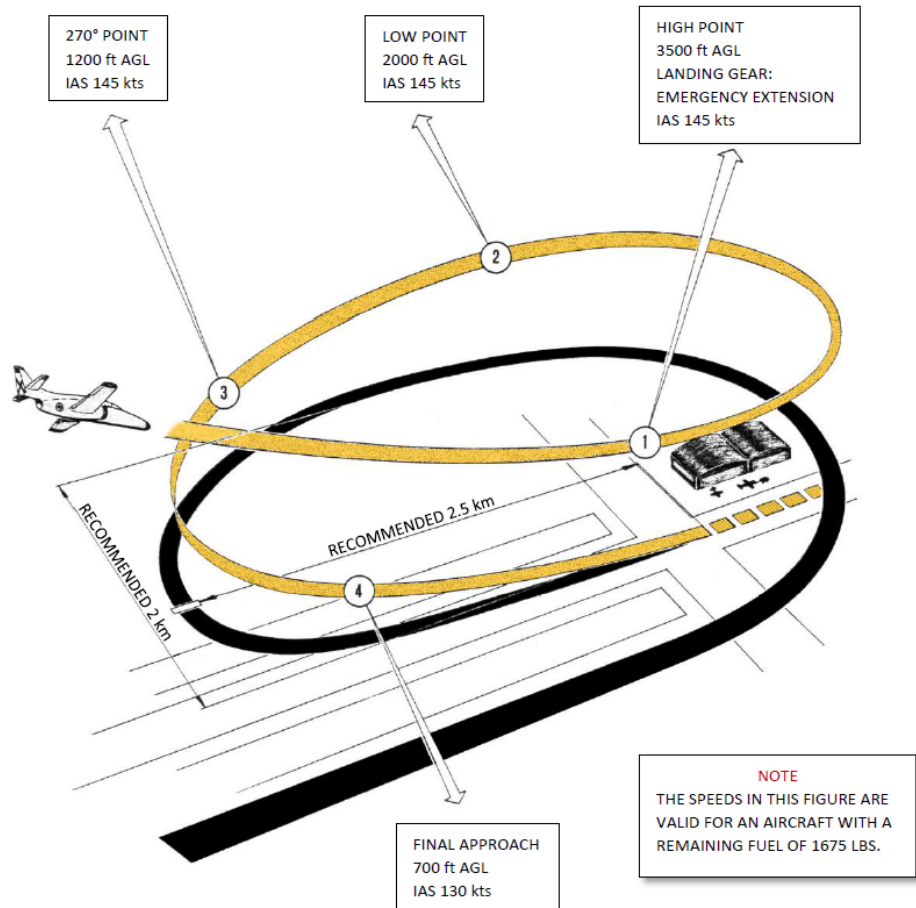


Figure 5-3 Typical flame-out approach pattern

5.13. LANDING WITH HYDRAULIC FAILURE

1 USE EMERGENCY BRAKING SYSTEM	
Differential braking is not possible using the emergency braking system. Equal pressure is simultaneously applied to both wheel brakes on brake application.	

5.14. LANDING WITH BRAKE FAILURE

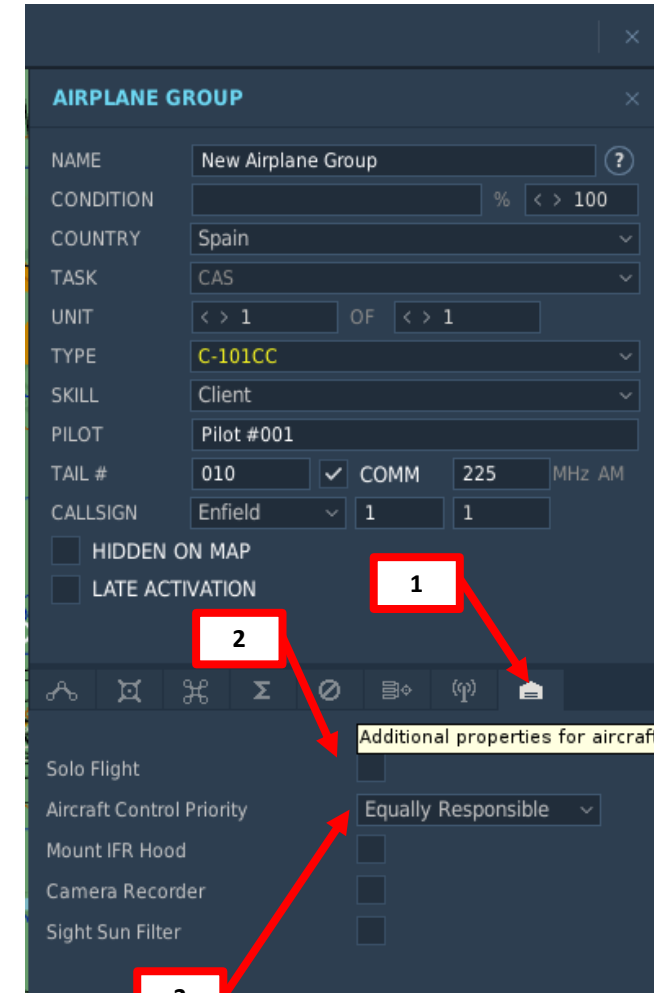
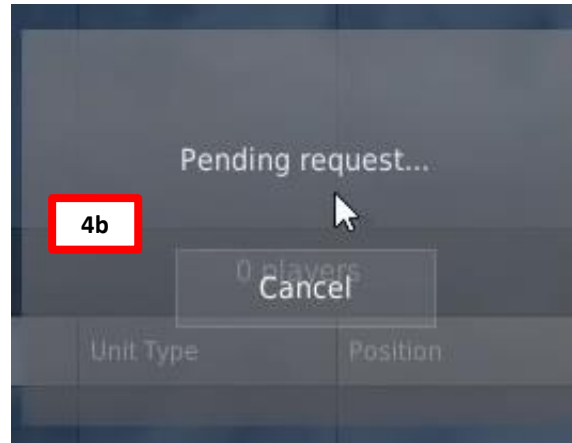
1 EMERGENCY BRAKE HANDLE	PULL
Differential braking not available.	
If runway excursion is inevitable and terrain is not favorable:	
1 CRASH BUTTON	PUSH
2 GEAR	RETRACT

HOW TO MULTICREW

The C-101 can be flown by two players in multiplayer. However, you need to go in the Mission Editor and make sure the C-101 is set up in the following manner:

1. Select C-101 Unit and go in “Additional Properties for Aircraft” menu
2. Make sure “Solo Flight” option is not ticked
3. Set “Aircraft Control Priority” to “Equally Responsible”
4. When spawning in multiplayer in the rear seat of the C-101, the front seat pilot will receive a request to let you take control of the rear seat (or not).
5. Once you are spawned, you can take control of the aircraft by pressing the “Request Aircraft Control” binding (“J” key).

Here is a nice tutorial made by the Grim Reapers
 Link: https://youtu.be/u5kYJXRS_o8



MULTIPLAYER - Select role

Spectators		BLUE COALITION	0 players					PLAYERS POOL	Cap
Cap	stahlwollvieh	Group	Unit Type	Position	Country	#	Airfield	Player	
		New Airplane Group	C-101CC	Pilot	RUS	011	Air		
		New Airplane Group	C-101CC	Pilot2	RUS	011	Air		
		New Airplane Group	C-101CC	Pilot	RUS	010	Air		
		New Airplane Group #001	C-101CC	Pilot2	RUS	010	Air		
		New Airplane Group #001	C-101CC	Pilot	RUS	012	Fujairah Intl		
		New Airplane Group #001	C-101CC	Pilot2	RUS	012	Fujairah Intl		
		New Airplane Group #001	C-101CC	Pilot	RUS	013	Fujairah Intl		
		New Airplane Group #001	C-101CC	Pilot2	RUS	013	Fujairah Intl		

4a



I would like to personally thank the Aviodev Team for their stellar support during the writing of this guide. They spent countless hours providing me clarifications, helping me understand certain systems and even going as far as creating training material on the Flight Director modes specifically for me when I asked. They are a passionate bunch, and they really care. These developers worked hard for many years to bring this product to the mature state it's in today, and the result is nothing short of impressive.



C-101 AVIOJET



- INSTANT ACTION
- CREATE FAST MISSION
- MISSION
- CAMPAIGN
- MULTIPLAYER

- LOGBOOK
- ENCYCLOPEDIA
- TRAINING
- REPLAY

- MISSION EDITOR
- CAMPAIGN BUILDER

- EXIT

Nevada 2.5.0	A-10C	AJ537	AV8B NIGHT ATTACK Dev 2.5.x	Bf 109 K-4	C-101 Beta	CA	Caucasus 2.5.0	Christen Eagle II	F-5E	F-86F	F/A-18C EA	FC3	Dora Fw 190 D-9	Ka-50	L-39	M-2000C